



Components

pool kit line



solutions KIT

linea  
pool kit



# Aqua industrial group

## IL FUTURO È QUI

Gentile utente, sfogliando il catalogo troverà una serie di codici QR come quello che vede sotto.

Fotografandoli con l'apposita applicazione di lettura contenuta nel suo smartphone avrà un accesso diretto ad approfondimenti multimediali (testi, video, ecc) relativi all'argomento trattato nel capitolo. Provi con questo primo codice che la porterà direttamente al tutorial AQUA.

## THE FUTURE IS NOW

Dear user, flipping through the pages of our brochure you will find QR codes as the one below.

Please scan them through the special software on your Smartphone so you can access directly to the multimedial details (text, video etc) regarding the arguments discussed in the chapter. Try with this first code that will bring you directly to the Aqua's video.



we've a  
special  
future

# Indice generale

*General index*



01	<b>Pool kit</b> <i>Pool kit</i>	pag.	10
02	<b>Piscine pubbliche A2 BSF</b> <i>Type A2 Public pools overflow</i>		20
03	<b>Piscine pubbliche B BSF</b> <i>Type B Public pools overflow</i>		38
04	<b>Piscine private D BSF</b> <i>Type D Private pools overflow</i>		56
05	<b>Piscine pubbliche A2 skimmer</b> <i>Type A2 Public pools skimmer</i>		72
06	<b>Piscine pubbliche B skimmer</b> <i>Type B Public pools skimmer</i>		90
07	<b>Piscine private D skimmer</b> <i>Type D Private pools skimmer</i>		108
08	<b>Piscine pubbliche A1</b> <i>Type A1 Public pools</i>		128
09	<b>Piscine personalizzate</b> <i>Customised pools</i>		130
10	<b>Normative</b> <i>Standards</i>		133

# Aqua industrial group



ITALY

GREAT BRITAIN

FRANCE

GERMANY

SPAIN

POLAND







we've a special future

ROMANIA TURKEY DUBAI INDIA RUSSIA EGYPT LEBANON



# Aqua industrial group



Industrial power





9 stabilimenti  
32.000 mq coperti  
11 filiali  
110 paesi raggiunti  
320 dipendenti  
8.166 codici prodotto

*9 factories*  
*32.000 mq indoor*  
*11 branches*  
*110 countries*  
*320 employees*  
*8.166 product codes*

Distretti produttivi

- S. Martino in Rio (RE)
- Rieti
- Gandino (BG)
- Borgo Val di Taro (PR)
- Warszawa PL
- Bangalore IND

*Production districts*

- S. Martino in Rio (RE)*
- Rieti*
- Gandino (BG)*
- Borgo Val di Taro (PR)*
- Warszawa PL*
- Bangalore IND*

we've a special future







40 presse ad iniezione da 50 a 1.700 t.  
845 stampi di propriet   
12 estrusori per cartucce melt-blown  
2 forni di fusione  
20 avvolgitrici per cartucce

2 saldatrici per la produzione  
di bombole e filtri  
1 impianto di cardatura  
ed avvolgitura filo polipropilene  
6 telai per manto erboso sintetico

everything from our factories





# From industry to you



*40 injection molding machines from 50 to 1.700 t.  
845 proprietary molds  
12 extruders for cartridges melt-blown  
2 melting furnaces  
20 winders for cartridges*

*2 welding machines for the production  
of tanks and filters  
1 system of carding  
and winding polypropylene thread  
6 looms for synthetic-grass*





# linea pool kit



**Aqua è lieta di presentare i "POOL KIT".** Il "POOL KIT" è un concentrato di informazioni e relazioni utili per una perfetta installazione della piscina.

Aqua offre sistemi integrati, progettati e collaudati, corredati di tutta la documentazione tecnica, per facilitare in modo sensibile tutta la sua clientela.

- |                 |                  |
|-----------------|------------------|
| 1) Struttura    | 4) Filtrazione   |
| 2) Rivestimento | 5) Illuminazione |
| 3) Circolazione | 6) Accessori     |

Tutti i kit di AQUA rispondono a tutte le normative di sicurezza e costruttive, ai nuovi obblighi legislativi, garantendo la massima tranquillità nelle operazioni di costruzione di una piscina; sapendo di disporre di un kit completo di tutti i materiali necessari, calcolati per ottimizzare le fasi di posa e di conseguenza minimizzare sensibilmente i costi di cantiere.

I kit sono anche presenti sul catalogo "Componenti e Accessori Piscine) e sono perfettamente modulari.

Con i "POOL KIT" verrà anche consegnata una serie di documenti per facilitare la compilazione dei moduli come da obblighi di legge ed una descrizione precisa di tutte le fasi di installazione dei componenti.

Per ogni "POOL KIT" sono disponibili delle tabelle che riportano i dati identificativi, inoltre sono scaricabili negli approfondimenti numerose informazioni aggiuntive, schede tecniche, aggiornamenti argomenti collegati.

**Aqua is proud to present the "POOL KIT".** "POOL KIT" is a packed with useful information and reports for a perfect installation of the pool.

Aqua offers integrated systems, designed and tested, equipped with all the technical documentation to facilitate significantly all its customers.

- |                |                |
|----------------|----------------|
| 1) Structure   | 4) Filtration  |
| 2) Coating     | 5) Lighting    |
| 3) Circulation | 6) Accessories |

All AQUA kit meet all safety standards and construction, the new legislative obligations, ensuring maximum tranquility in building swimming pool operations; knowing to have a kit with all necessary materials, calculate to optimize all the phases of installation and therefore minimize considerably the yards costs.

The kits are also available on the catalogue "Components and Accessories Pools) and are perfectly modular. With "POOL KIT" will also delivered a series of documents to facilitate the completion of the forms as legal obligation and a precise description of all phases of components installation.

For every "POOL KIT" are available in the tables that show all technical features, it also be downloaded numerous additional information, data sheets, updates and related topics.



*pool kit line*





## MODULO 80



## Modulo 80

Modulo 80



### DESCRIZIONE

**STRUTTURA:** Tutte le installazioni hanno come punto di partenza una struttura, un telaio, una base.

Aqua Industrial Group presenta il MODULO 80; una struttura studiata e progettata al proprio interno, frutto di esperienza, conoscenza e consapevolezza, rispettando tutte le normative vigenti. MODULO 80 è una struttura **autoportante** costruita appositamente per il mercato delle piscine, ogni singolo particolare è studiato per agevolare il lavoro dell'installatore.

Ogni dettaglio è fondamentale, lo è da sempre, per questo motivo la nostra struttura è eseguita con uno stampo std con passo da 80 cm e due millimetri di spessore; eseguita con nervature, angoli, pieghe ed imcastrì per aumentare la robustezza strutturale; più contrafforte posteriore; predisposta con forature (skimmer, fari, bocchette) cieche.

Viti di regolazione sul fondo permettono all'installatore un accoppiamento perfetto tra i pannelli in modo orizzontale, sul contrafforte posteriore, invece, è presente un'asola più un foro per un posizionamento millimetrico in modo verticale.

Inoltre il MODULO 80 si presta a tutte le tecnologie: skimmer o bordo sfioro, con possibilità di altezze e svariate opzioni.



### DESCRIPTION

**STRUCTURE:** All installation have as a starting point a structure, a frame, a base.

Aqua Industrial Group present the "MODULO 80"; a structure designed and built in house, the result of experience, knowledge and awareness, respecting all applicable regulations.

MODULO 80 is a **self-supporting** structure built specifically for the swimming pool market, every single detail is designed to facilitate the work of the builder.

Every details is important, it always been, for this reason our structure is made with a std mold with a 80cm pitch and 2 millimeters with ribs, corners, bends to increase the structural strength, plus back support; prepared with blind holes (skimmers, lights, nozzles).

Adjustment screws on the bottom allow to the builder a perfect match between the panels horizontally; and on the back support, there is a loop hole more another hole for a millimeter positioning vertically.

Furthermore MODULO 80 lends itself to all the technology: skimmer or overflow, with the possibility of heights and various options.



### CARATTERISTICHE TECNICHE

- Pannello prodotto con lega di acciaio, magnesio
- Produzione industriale std con passo da 80 cm x 2 mm di spessore
- Altezze differenti 120-130-140-150
- Struttura Rettilinea e Forma libera
- Sistema a Skimmer o Bordo Sfiatore
- Completa con forature, viti, dadi, tasselli ecc.
- Regolazione tramite 2 viti per facilitarne l'accoppiamento
- Asola sul contrafforte per facilitare la messa in bolla
- Doppia guarnizione sugli articoli ABS



### TECHNICAL FEATURES

- Panel produced with steel alloy and magnesium
- Industrial production std with pitch 80cm x 2 mm of thick
- Heights different 120-130-140-150
- Structure straight or free form
- Systems with Skimmers or Over flow
- Complete with holes, screws nuts, bolts etc.
- Adjustment with 2 screws for easy coupling
- Loop hole on back support for easily leveling
- Double gasket on ABS articles



### APPROFONDIMENTI/ DETAILS

I codici "KIT" vengono consegnati completi di tutto il materiale necessario  
The codes "KIT" are delivered complete with all the necessary materials

Codice/Code	Descrizione/Description	Unit
8001200001L	Pannello piano senza fori L80 H 120 IL/ Flat panel without hole l80	NR
8001200021L	Pannello piano foro skimmer sfioratore L80 H 120 IL/ Flat panel with overflow skimmer hole l80	NR
800120ASP1L	Pannello piano per aspiaf. L80 H 120 IL/ Flat panel for mud suction nozzle l80	NR
8001200031L	Pannello piano foro faro classic L80 H 120 IL/ Flat panel with classic light hole l80	NR
8001200901L	Pannello ad angolo 90° senza fori 40x40 H 120 IL/ 90° Corner panel without hole 40x40	NR
8001200071L	Contrafforte H120 IL/ Back support h120	NR
800800024B	Viti 12x20 zn br/ Screw 12x20 zn br	NR
800800025B	Viti m 12x60 zn br/ Screw m 12x60 zn br	NR
800800002C	Dadi m 12 zn quadro/ Nuts m 12 zn square	NR
800800026C	Tassello metallico inox/ Metal anchor bolt	NR
800800023V	Viti m 8x60 zn/ Screw m 8x60 zn	NR
800800023S	Spessore 2mm di regolazione/ 2Mm spacer for adjustments	NR

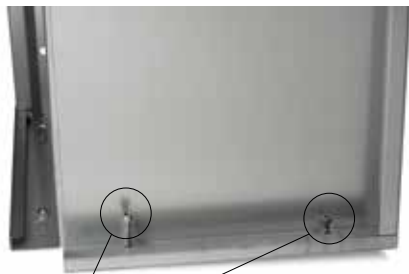

Viti di regolazione livello posa pannelli  
Panel positioning level adjustment screws



Sistema a incastrò senza saldature  
Snap-on system without welds

Inserti per viti di regolazione canale sfioratore  
Inserts for overflow channel adjustment screws

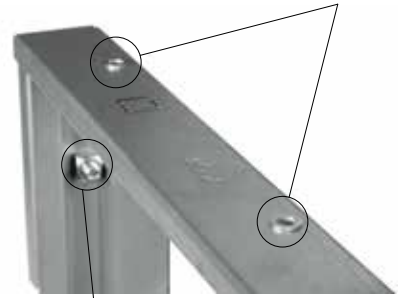

Dado quadro per accoppiamento pannelli  
(non necessita di chiave)  
Square nut for panel coupling  
(no need of wrench)

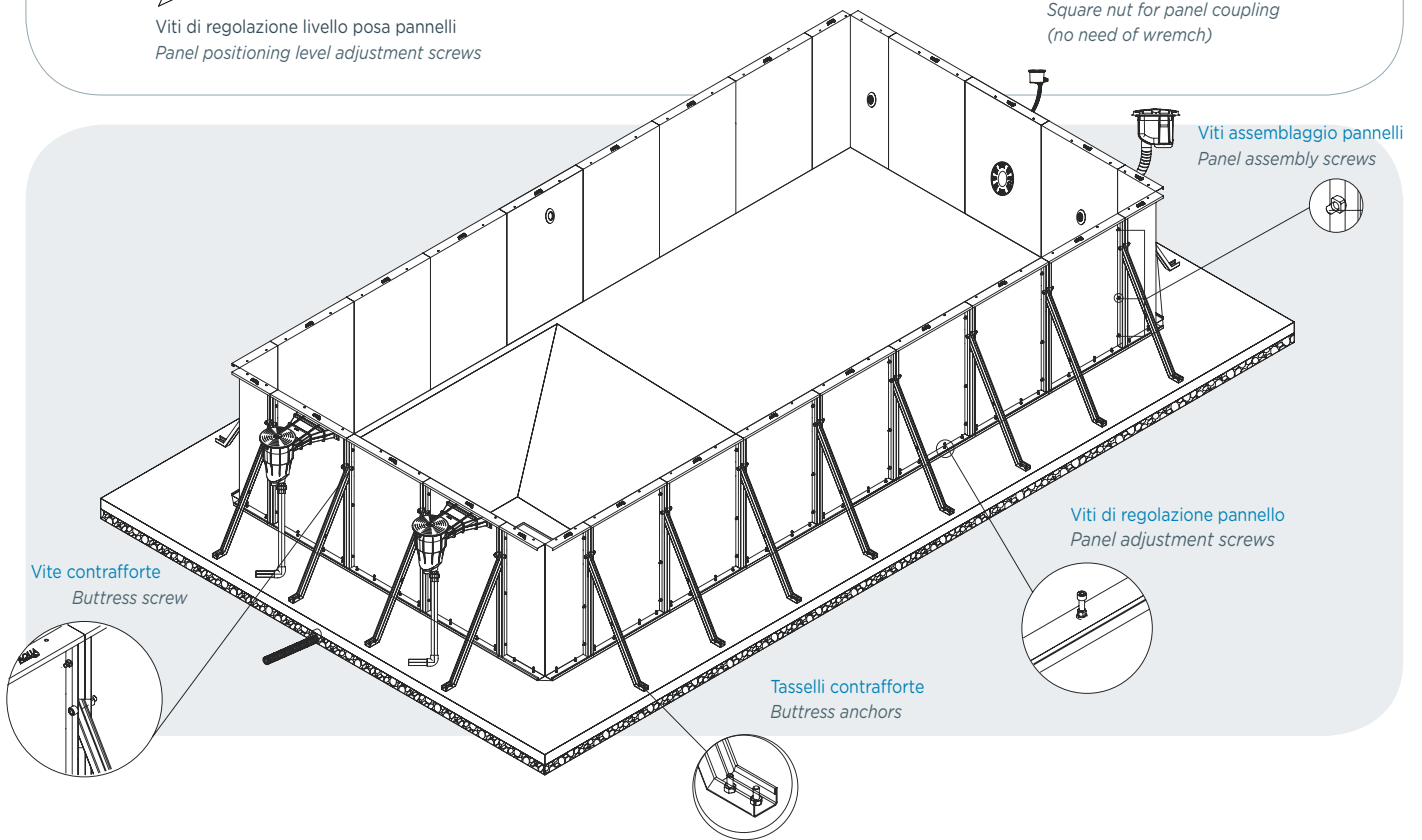

REGOLA



Canale sfiore rettilineo REGOLA

REGOLA straight overflow channel

Canale sfiore in acciaio magnesius sp 1,5 mm. Realizzato per alloggiamento griglia da 25 cm su forme rettilinee in abbinamento a struttura Modulo 80. Consente regolazioni millimetriche del livello di sfiore, variazione di profondità da 17 a 25 cm e regolazione di pendenza interna. Da rivestire con telo in pvc.

Overflow channel in magnesius steel tickness 1,5 mm. Designed for 25 cm grid slot on straight shapes in combination with Modulo 80. It allows the millimetric adjustment of overflow level, depth variation from 17 to 25 cm as well as the adjustment of internal slop. To be coated with liner in PVC.



DESCRIZIONE

REGOLA il canale sfiore, abbinabile in qualsiasi momento ad una qualsiasi struttura MODULO 80.

Studiato e progettato al proprio interno per risolvere i problemi più comuni, estremamente resistente 1,5mm è stato ideato per avere tre prodotti in uno;

La messa in bolla del canale è diventata semplice, grazie alle viti di regolazioni già presenti nel MODULO 80; l'installatore ha la possibilità di adeguare la profondità del canale REGOLA a suo piacimento; inoltre può anche aggiustare la pendenza per convogliare il flusso dell'Acqua.



DESCRIPTION

REGOLA the overflow channel, matched any time to any MODULO 80 structures.

Designed and built in house to solve common problems, extremely durable 1,5mm thick is designed to have 3 products in one.

The leveling of the canne has become easier, tank to the adjustment screws already present in MODULO 80; the builder has the possibility to adjust the channel depth REGOLA; can also adjust the slope of the channel and regulate the flow of the water.



CARATTERISTICHE TECNICHE

- Produzione industriale con misure std 1,5 mm di spessore
- Alloggiamento griglia da 25cm
- Messa in bolla tramite 2 viti di regolazione
- Regolazione di profondità da 17 a 25 cm
- Aggiustamenti della pendenza fino a 2,5 cm
- Piletta Ø125
- Completa con forature, viti, dadi, tasselli ecc.
- Modalità Rettilinea e Forma libera
- Da rivestire con telo PVC



TECHNICAL FEATURES

- Industrial production with std measures 1,5 mm thick
- Housing grid 25cm
- Leveling with 2 adjustments screws
- Depth adjustment from 17 to 25 cm
- Adjustment of the slope up to 2,5 cm
- Drain Ø125
- Complete with holes, screws, nuts, bolts etc.
- Possibility straight and free form
- To coat with Liner PVC



APPROFONDIMENTI/ DETAILS

I codici "KIT" vengono consegnati completi di tutto il materiale necessario  
The codes "KIT" are delivered complete with all the necessary materials

Codice/Code	Descrizione/Description	Unit
802100007	Canale di sfiore diritto reg MT 1 compl distinta/ Straight overflow channel 1m	NR
802100005	Canale di sfiore diritto reg MT 2 compl distinta/ Straight overflow channel 2m	NR
802100161	Canale di sfiore MT 2 con piletta distinta/ Straight overflow channel 2m with d.125 Drain	NR
802100037	Canale di sfiore diritto reg MT 0,6 compl distinta/ Straight overflow channel 0,6m	NR
802100013	Canale di sfiore rett ang 90 MT 0,5 x 0,5 compl distinta/ 90° Corner ovefrflow channel 50x50	NR
802100016	Squadra regolabile di sostegno canale sfiore compl distinta/ Overflow channel support bracket	NR
800800024V	Vite m 10 x 60 UNI 5931 (TCEI) ZN 8.8/ Screw m 10 x 60 UNI 5931 (TCEI) ZN 8.8	NR
800800024	Dado m10/ Nuts m10	NR
800800025	Rondella zincata mm 10 din 125A/ Galvanized washer mm 10 din 125A	NR



Vite di regolazione e sostegno profilo sfioratore  
Supporting and adjusting screw (overflow profile)



Angolo a 90°  
90° Angle



Asole di regolazione profondità del canale con possibile  
inclinazione della griglia  
Channel depth adjustment slots with possible grid inclination

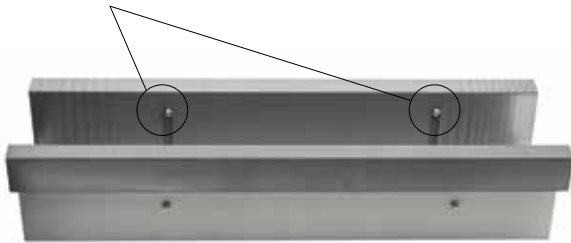

Canale sfioratore regolabile  
Adjustable overflow channel

Regolazione con inclinazione della pendenza interna  
Adjustment with internal slope inclination

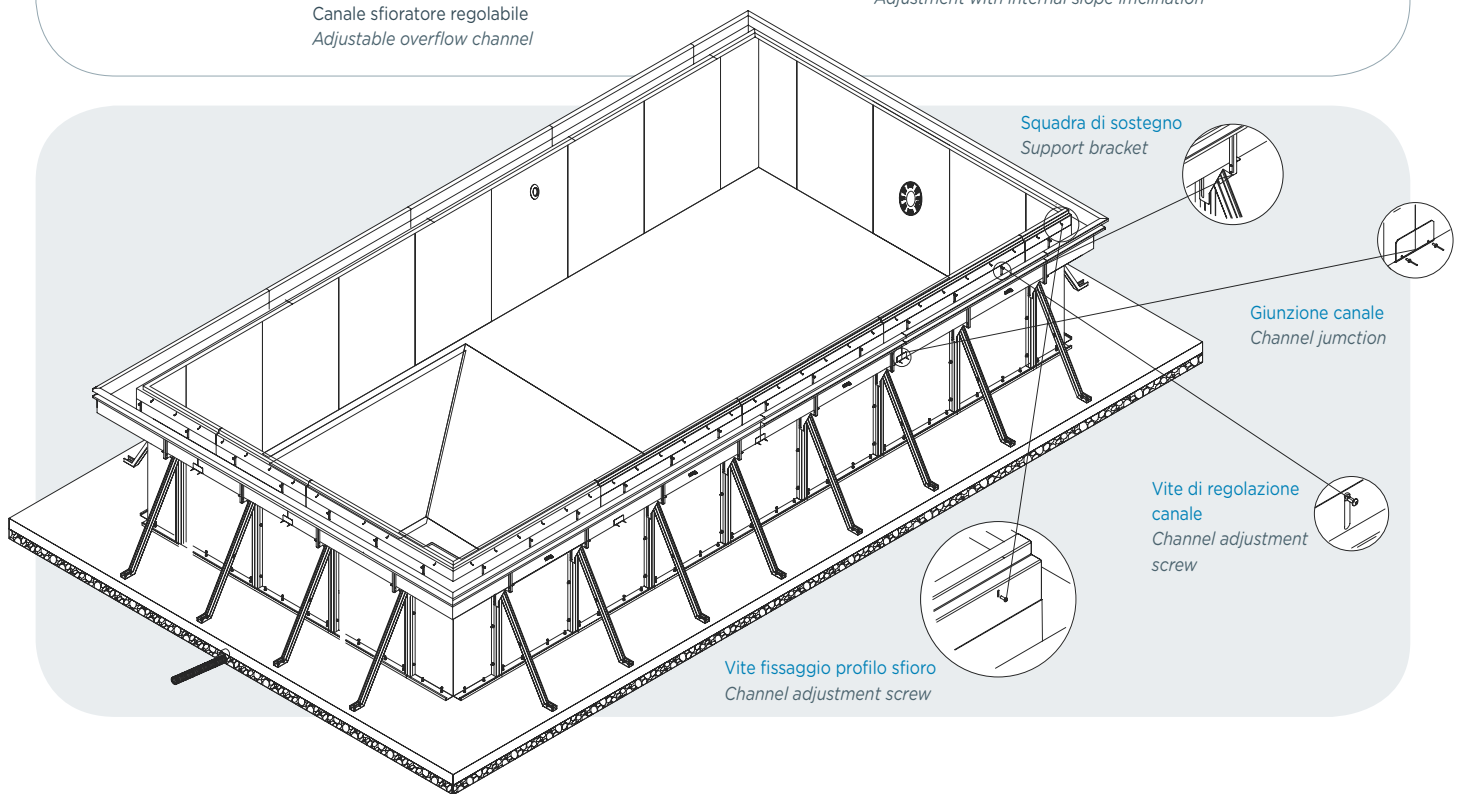
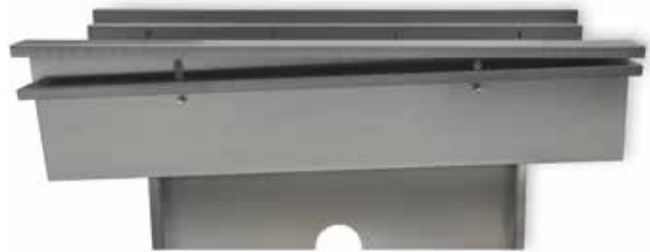

## RIVESTIMENTO



## Kit Rivestimento

Coating Kit



### DESCRIZIONE

Niente più calcoli di rotoli e metri-quadrati, il KIT RIVESTIMENTO è stato pensato per offrire in un solo codice tutto il materiale necessario per il completamento di una piscina. Il KIT RIVESTIMENTO è stato minuziosamente composto con tutto il materiale necessario, in relazione al dimensionamento della piscina.



### DESCRIPTION

No more calculations of rolls and square-meters, the COATING KIT has been designed to offer in a single code all the materials necessary for the completion of a swimming pool. The COATING KIT was meticulously composed with all the necessary material, in relation to the swimming pool size



### CARATTERISTICHE TECNICHE

- Composto da doppia membrana di PVC 1,5mm rinforzato con rete di Nylon
- Disponibilità in diversi colori
- Profilo in alluminio dritto e pretagliato
- Fettuccina in pvc
- Pvc liquido e solventi thf
- Fornito con rivetti 3,4x11 e chiodi ad espansione



### TECHNICAL FEATURES

- Compound in a double PVC membrane 1,5mm thick reinforced with Nylon net.
- Available in different colors
- Aluminum profile straight and precut.
- Pvc tape
- Pvc liquid and thf solvent
- Supplied with 3,4x11 rivet and expansion nails



### APPROFONDIMENTI/ DETAILS

I codici "KIT" vengono consegnati completi di tutto il materiale necessario  
The codes "KIT" are delivered complete with all the necessary materials

Codice/Code	Descrizione/Description	Unit
800800034	Rivest. Elbe azzurro h 1,65/ Elbe lining light blue h 1.65	MQ
800800062E	Pvc liquido azzurro e/ Liquid pvc light blue e	NR
808800022	Prof.All.Anod.Largo/ Large anodized aluminium profile	MT
808800025	Prof.Pvc bianco mm 9x3(50 ml)/ Pvc profile 9x3 m50	MT
808800009	Rivetti alluminio 3,4 x 11/ Aluminium 3.4x11 rivets	NR
808800011	Chiodo espansione 4,8 x 26/ Aluminium 4.8X26 expansion bolts	NR
808800040	Solvente thf 1 lt/ Thf thinner 1l	NR
800800049	Flacone applicat.Pvc liquido/ Liquid pvc applicator bottle	NR

## CIRCOLAZIONE

## Kit Circolazione

### Circulation Kit



#### DESCRIZIONE

Come ben sapete, l'equilibrio e la linearità sono alla base di ogni circolazione per piscina.

È stato proprio questo l'obiettivo principale nella creazione dei KIT CIRCOLAZIONE, ogni singola caratteristica tecnica di ogni singolo prodotto è stata tenuta in considerazione; niente è stato lasciato al caso.

Il posizionamento delle mandate e aspirazioni, fondamentale nella movimentazione dell'acqua; gli accessori presenti o predisposti e non meno importante il pieno rispetto delle normative EN-UNI e legislazioni europee.



#### DESCRIPTION

As everybody know, balance and linearity are the basis of every swimming pool circulation of water.

It is exactly the main objective in the creation of CICRULATION KIT, each technical specification of each products has been taken in consideration; nothing was left without study.

The positioning of injections and suctions, fundamental for water movement; the present accessories or predisposal one and not least the full compliance UN\_EN and European legislation.



#### CARATTERISTICHE TECNICHE

- Adeguato n° di Skimmer
- Adeguato n° di bocchette
- Adeguate prese di fondo
- Predisposizione per aspira-fango e regolatore di livello
- Kit di collegamento
- Tubazioni e raccorderia



#### TECHNICAL FEATURES

- Appropriate n° of Skimmers
- Appropriate n° of nozzles
- Adequate main drains
- Predisposal for suction-mud and level regulator
- Connection Kit
- Pipes and fittings



#### APPROFONDIMENTI/ DETAILS

I codici "KIT" vengono consegnati completi di tutto il materiale necessario  
The codes "KIT" are delivered complete with all the necessary materials

Codice/Code	Descrizione/Description	Unit
200200003	Sk sfioratore CA/L acqua/ Overflow skimmer CA/L	NR
107100901	Kit collegamento skimmer sfioratore per pannelli e cemento d.50 H1200/ Overflow skimmer connection kit d.50 For panel pool H1200	NR
200200016F	Bocchetta pann filetto 2"m acqua/ Nozzle with ball-type jet 2"m aqua	NR
107100902	Kit collegamento bocchetta per pannelli d.50 H1200/ Wall nozzle connection kit d.50 For panel pool H1200	NR
200200037	Presa di fondo CA/L imcoll. Antivortice aqua/ Main drain CA/L glue antivortex	NR
100200560	Rid.Pvc M/F corta imc. 63X50/ Reduction Pvc M/F glue 63x50	NR
100200910	Tubo fless.Imc.D 43x50 25 ml/ Flexible pipe glue d 43x50 25 ml	MT
100200000G	Collante WDF-05 con tampone/ Instant glue edf-50 with swab	NR
100200050	Detergente tangit It 1/ Tangit detergent It	NR
200200059	Regolatore di livello meccanico aqua/ Mechanical level regulator	NR
200200046F	Corpo bocchetta CA/L filetto aqua/ Nozzle body CA/L aqua	NR
200200020	Griglia per bocchetta aqua/ Nozzle grid aqua	NR



## FILTRAZIONE



## Kit Filtrazione

Filtration Kit



### DESCRIZIONE

Impianto pre-assemblato; ideato per raggiungere elevate performances nel pieno rispetto delle normative vigenti. Progettato e prodotto seguendo precisi standard qualitativi, dall'inizio alla fine l'articolo è MADE IN ITALY con un processo totalmente industrializzato; il kit è corredato di: Tavole di installazione (opere edili, forometrie, attacchi luce/acqua, ecc.) e di Completi schemi di funzionamento. L'impianto è totalmente modulare, con una moltitudine di accessori, facilmente installabili anche dopo il primo start-up.



### DESCRIPTION

Pre-assembled plant, designed to achieve high performance, in full compliance of the regulation. Designed and manufactured with exacting quality standards, from start to finish the item is MADE IN ITALY with a fully industrialized process; the kit is finished with: installation manual (building works, perforated patterns, electrical and water attacks, etc.) and complete operation diagrams. The system is fully modular, with a multitude of accessories, easily installed even after the first start up.



### CARATTERISTICHE TECNICHE

- Conformità alla normativa "UNI 10637"
- Batteria frontale con valvole e manometri
- Pompe centrifughe + pompa di scorta (trifase)
- Collettori assemblati con flange libere
- Punti di lettura e analisi
- Predisposizione trattamento chimico
- Tavole di cantiere; locale e forometrie
- Tavole di installazione e assemblaggio
- Tavole di funzionamento e manutenzione



### TECHNICAL FEATURES

- Complies with "UNI 10637"
- Front battery with valves and pressure gauge
- Centrifugal pumps + spare pumps (threephase)
- Assembled Collectors with loose flanges
- Points of reading and analysis
- Predisposal chemical treatment
- Table of the yard; technical room and perforated patterns
- Tables of installation and assembly
- Tables of operation and maintenance



### APPROFONDIMENTI/ DETAILS

I codici "KIT" vengono consegnati completi di tutto il materiale necessario  
The codes "KIT" are delivered complete with all the necessary materials

Codice/Code	Descrizione/Description	Unit
KDM500	Impianto 6 m <sup>3</sup> /h d.450 Kw 0,33 m 2 asp. 1 Mandata/ Filtration plant 6 m <sup>3</sup> /h d.450 Kw 0,33	NR
100100012	Sabbia quarzo 04/08-25 kg/ Quartz sand 04/08-25 kg	NR
100100832	Quadro el.1 Pompa sk m+ tr.105W + contr. Temp t1,6-12/ Elctrical panel1 t° control	NR

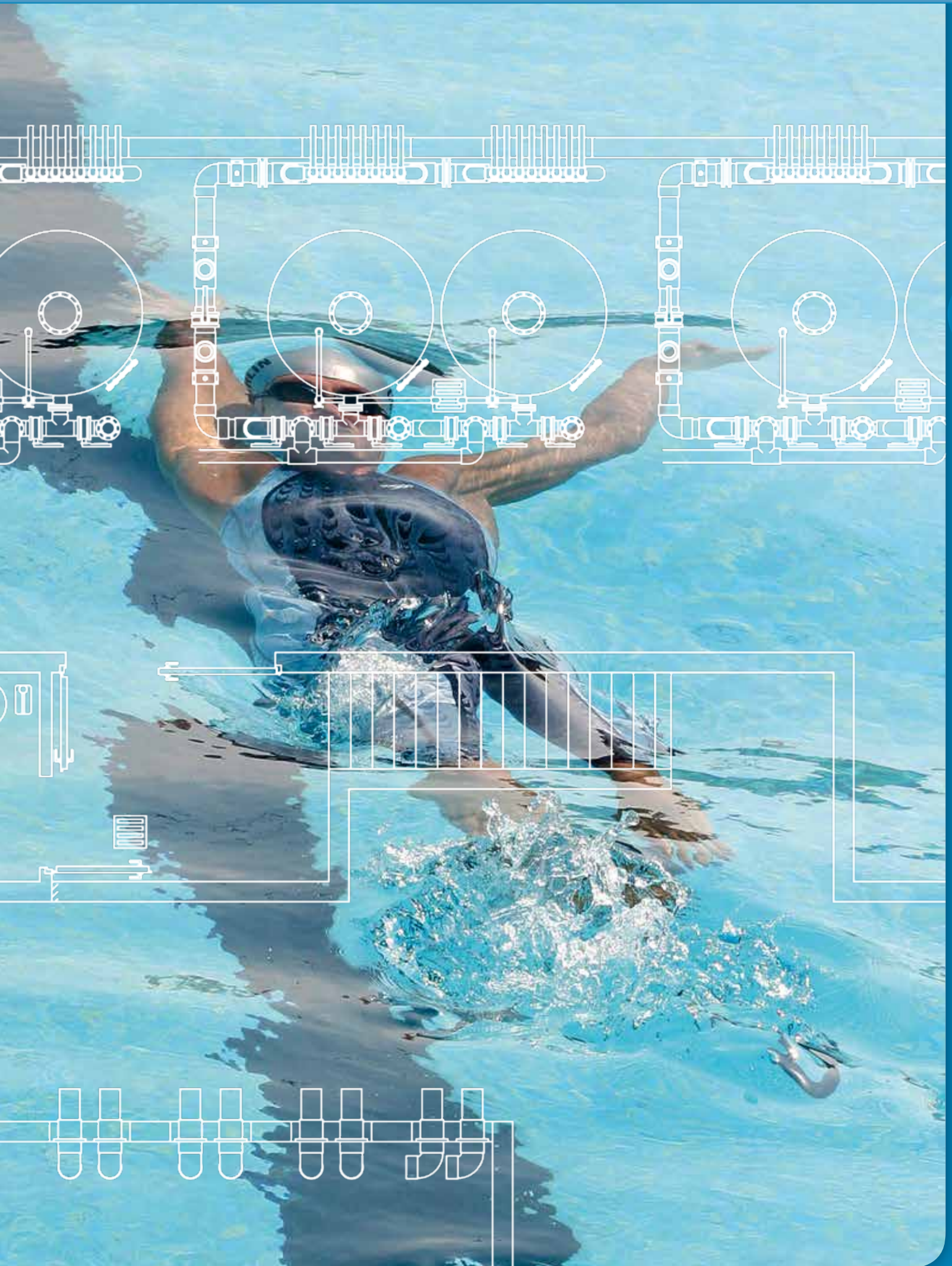



## PUBBLICA TIPO A2

A2

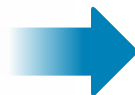

## PUBBLICA - TIPO A2 - BORDO SFIORO

PUBLIC - TYPE A2 - OVERFLOW EDGE

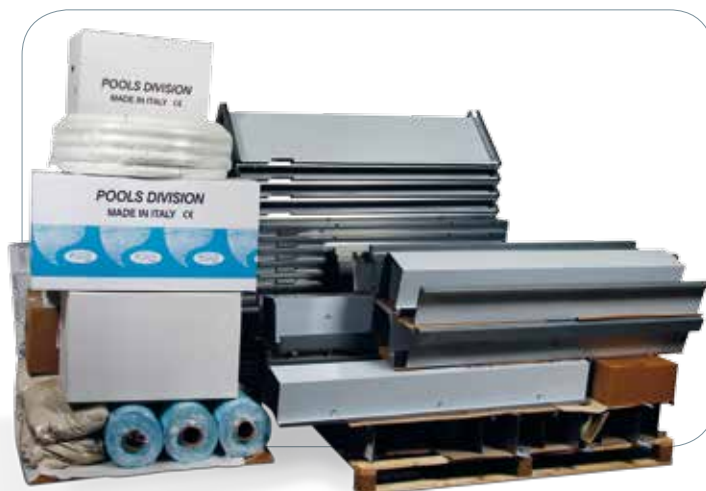

## CAMPO DI UTILIZZO

Piscine ad uso collettivo: sono quelle inserite in strutture già adibite, in via principale, ad altre attività ricettive (per esempio alberghi, camping, complessi ricettive, agriturismi e simili) nonché quelle al servizio della collettività (per esempio scuole, collegi, caserme, palestre e simili) accessibili ai soli ospiti, clienti, soci, o utenti



## CONTEXT OF USE

Pools for collective use: those included in the structures already engaged, primarily, to other accommodation facility (example hotels, camping, cottage and similar) as well those at the public (example school, boarding school, barracks, gym and similar) accessible only at the guests customers, partners or users.



## CARATTERISTICHE TECNICHE

## 1) STRUTTURA

Tecnologia a Bordo Sfiatore H 120cm +3(bsf) 130cm +3(bsf)  
Altezza Aqua > 140cm necessità presenza del bagnino  
Tempi di filtrazione differenti a seconda dell'altezza di Aqua  
(vedi tab. pag 135)

## 2) RIVESTIMENTO

PVC armato

## 3) CIRCOLAZIONE

L'immissione in vasca può avvenire dalle pareti o dal fondo, purché si garantisca l'omogeneizzazione.

I sistemi di ripresa immersi e le prese di fondo devono essere sempre collegate in coppia ad una distanza minima di 2 mt.

## 4) FILTRAZIONE

- Diametro minimo Ø 500mm
- Altezza minima Ø 1000mm
- Altezza minima letto filtrante Ø 600mm
- Velocità di filtrazione  $\delta 35\text{mc/h}$
- Pressione di collaudo deve essere  $\epsilon 1,5$  volte superiore alla pressione massima di esercizio.
- Pressione massima di esercizio con un minimo di 350Kpa.
- Deve essere previsto un numero di filtri  $\geq 2$ ; tutti i filtri devono avere medesime caratteristiche
- Deve essere previsto un numero minimo di pompe, tante quante sono i filtri più 1 di scorta.
- Devono essere previsti minimo 5 punti di lettura.

## 5) ILLUMINAZIONE

- Led

## 6) QUADRO ELETTRICO

- Trifasi



## TECHNICAL FEATURES

## 1) STRUCTURE

Overflow technology H 120cm +3(ovf) 130cm +3(ovf)  
Water height > 140cm need the presence of the lifeguard  
Filtration time different depending on the water height (see tab. page 135)

## 2) COATING

Reinforced PVC

## 3) CIRCULATION

The return of the water in the pool can be from the wall or from the bottom, provided it is ensure homogenization.

The suction of the swimming pool and the main drain must always be connected in pairs at a minimum distance of 2 meters

## 4) FILTRATION

- Minimum Diameter Ø 500mm
- Minimum height Ø 1000mm
- Minimum height filtration material Ø 600mm
- Filtration speed  $\delta 35\text{mc/h}$
- Pressure test must be  $\epsilon 1,5$  time higher than the maximum pressure.
- Maximum with a minimum of 350Kpa.
- Must be provided a minimum number of filters  $\geq 2$ ; all the filters must have the same characteristic
- Must be provided a minimum number of pumps, as many filters plus 1 spare.
- Must be provided at least 5 check points.

## 5) LIGHTING

- Led

## 6) ELECTRICAL BOARD

- Three-phase



**NORMATIVE**

Normativa NTC 2008 - L. n°1086 del 05.11.1971: "Norme per la disciplina delle opere in conglomerato cementizio armato, normale e precompresso e in struttura metallica";  
 Ordinanza n°3274 del 20.03.2003: "Primi elementi in materia di criteri generali per la classificazione sismica del territorio nazionale e di normative tecniche per la costruzione in zona sismica";  
 D.M. del 14.01.2008: "Norme Tecniche per le costruzioni NTC 2008";  
 Circolare ministeriale n°617 del 27.02.2009: "Istruzioni per l'applicazione delle Norme Tecniche per le Costruzioni";  
 EC3: EUROCODICE 3 EN 1993 1-3; 1-5; 1-2.  
 Carichi e movimentazione D. Lgs. 81/08 (ex 626). (MAX KG.30)  
 UNI EN 10637:2006  
 UNI EN 13451-1:2002 e 13451-3:2002  
 UNI EN 13451-1:2002 e 13451-1:2002

**STANDARDS**

NTC 2008 Standard - Italian Law no. 1086 of 05.11.1971: "Regulations for works in reinforced concrete, pre-stressed reinforced concrete and metal structures";  
 Italian Order no.3274 of 20.03.2003: "Basic notions on general seismic classification criteria for the national territory and technical rules for construction in seismic areas";  
 Italian Ministerial Decree of 14.01.2008: "Technical Standards for Construction NTC 2008";  
 Italian Ministerial Circular no. 617 of 27.02.2009: "Instructions for the application of Technical Standards for Construction";  
 EC3: EUROCODE 3 EN 1993 1-3; 1-5; 1-2.  
 Loads and handling - Italian Legislative Decree 81/08 (ex 626). (MAX KG.30)  
 UNI EN 10637:2006 - UNI EN 13451-1:2002 and 13451-3:2002  
 UNI EN 13451-1:2002 and 13451-1:2002



Acquatico, Reggio Emilia Acquatico, Reggio Emilia

## PUBBLICA TIPO A2

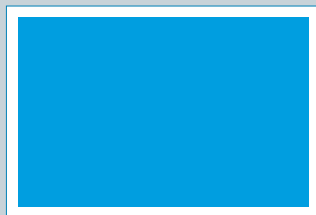

A2



## POOL KIT mt 4.00x8.00 - Tipo A2

piscine ad uso collettivo, inserite in strutture adibite principalmente ad altre attività ricettive o al servizio della collettività (alberghi, agriturismo, campeggi, palestre, scuole, caserme, etc.)

## POOL KIT 4.00x8.00 m - Type A2

pools for collective use, installed in facilities mainly offering other hospitality or public services (hotels, farm holiday houses, camping sites, gyms, schools, army barracks, etc.).

Codice Code	Altezza pannelli altezza acqua Panel height - Water height	Scala recessa Roman steps	Perimetro Perimeter	Area Surface	Volume Volume	Rivestimento in rotoli h 1.65 Azzurro Pool lining - rolls h.1.65, Light Blue	Rivestimento mq. Azzurro antiscivolo Pool lining sq. m Light Blue, non-slip	Filtrazione mc/h v 35 Filtration cu. m/h v. 35	Consumo in kw Consumption in kW	Aqua flex tubo rotoli mt.25 Aqua flex pipe, 25 m rolls	Vasca di compenso m <sup>3</sup> Compensation tank cu. m	Aspirafango Mud suction nozzle	N° bocchette No. of nozzles	N° presa di f. No. of main drains	N° fari led bianchi e blue No. of white and blue LED lights	Listino Price List
KABZA100	123		24.00	32.00	39.36	2½		9.00x2	0.50x3	3	3.5	1	2	2	2	€ 24.715,00
KABZA101	123	R 1.5	26.46	36.66	45.10	3	8.25	9.00x2	0.50x3	3	3.5	1	2	2	2	€ 27.385,00
KABZA102	123	1.6x2.4	27.20	35.84	44.09	3	8.25	9.00x2	0.50x3	3	3.5	1	2	2	2	€ 27.200,00
KABZA103	133		24.00	32.00	42.56	2½		9.00x2	0.50x3	3	3.5	1	2	2	2	€ 25.590,00
KABZA104	133	R 1.5	26.46	36.66	48.76	3	8.25	9.00x2	0.50x3	3	3.5	1	2	2	2	€ 28.380,00
KABZA105	133	1.6x2.4	27.20	35.84	47.67	3	8.25	9.00x2	0.50x3	3	3.5	1	2	2	2	€ 28.310,00



## OPTIONAL

Codice/Code	Descrizione/Description	Price
107101700	Vasca di compenso prefabbricata completa 3600lt/Complete pre-fabricate compension tank 3600lt	€ 2.370,00
ADSALT2050	Sterilizzatore Aqua Salt 50mc + pH/ Aqua Salt steriliser 50mc + pH	€ 1.700,00
ADPS200	Pannello dosaggio pH - CL/Dosing panel pH - CL	€ 2.726,20
700800304	Pompa di calore 1,5HP/Heat pump 1.5HP	€ 2.256,00
KCIT101	Copertura invernale completa/Complete winter covering	€ 580,00
KCIT109	Copertura invernale completa con scala romana R 1,5/Complete winter covering roman ladder R1.5	€ 753,00
KCIT117	Copertura invernale completa con scala rett 1,6x2,4/Complete winter covering rett ladder 1.6x2.4	€ 720,00
200300014	Lampada LED multicolor/Multi coloured LED lamp	€ 367,65
200300013	Lampada LED bianca/White LED lamp	€ 220,00



## APPROFONDIMENTI/ DETAILS

<http://aqua.quickris.com/pool-kit-mt-4-00x8-00-tipo-a2/>



## QR code

Fotografa il codice con lo smartphone e vai direttamente all'approfondimento

Scan the code with your smartphone to obtain more detailed information

## PUBBLICA TIPO A2

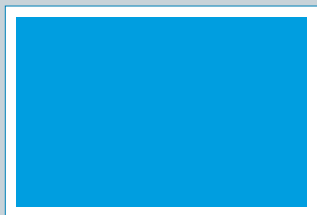

A2

## POOL KIT mt 5.00x10.00 - Tipo A2

piscine ad uso collettivo, inserite in strutture adibite principalmente ad altre attività ricettive o al servizio della collettività (alberghi, agriturismi, campeggi, palestre, scuole, caserme, etc.)



## POOL KIT 5.00x10.00 m - Type A2

pools for collective use, installed in facilities mainly offering other hospitality or public services (hotels, farm holiday houses, camping sites, gyms, schools, army barracks, etc.).

Codice Code	Altezza pannelli altezza acqua Panel height - Water height	Scala recessa Roman steps	Perimetro Perimeter	Area Surface	Volume Volume	Rivestimento in rotoli h 1.65 Azzurro Pool lining - rolls h 1.65, Light Blue	Rivestimento mq. Azzurro antiscivolo Rivestimento mq. Azzurro antiscivolo	Filtrazione mc/h v 35 Filtration cu. m/h v 35	Consumo in kW Consumption in kW	Aqua flex tubo rotoli mt 25 Aqua flex pipe, 25 m rolls	Vasca di compenso m <sup>3</sup> Compensation tank cu. m	Aspirafango Mud suction nozzle	N° bocchette No. of nozzles	N° presa di f. No. of main drains	N° fari led bianchi e blue No. of white and blue LED lights	Listino Price List
KABZA106	123		30.00	50.00	61.50	3½		15x2	1.1x3	4	5	1	3	2	2	€ 31.410,00
KABZA107	123	R 1.5	32.46	54.66	67.24	4	8.25	15x2	1.1x3	4	5	1	3	2	2	€ 34.365,00
KABZA108	123	1.6x2.4	39.20	53.84	66.23	4	8.25	15x2	1.1x3	4	5	1	3	2	2	€ 33.975,00
KABZA109	133		30.00	50.00	66.50	3½		15x2	1.1x3	4	5	1	3	2	2	€ 32.610,00
KABZA110	133	R 1.5	38.46	54.66	72.70	4	8.25	15x2	1.1x3	4	5	1	3	2	2	€ 35.590,00
KABZA111	133	1.6x2.4	39.20	53.84	71.61	4	8.25	15x2	1.1x3	4	5	1	3	2	2	€ 35.315,00



## OPTIONAL

Codice/Code	Descrizione/Description	Price
107101701	Vasca di compenso prefabbricata completa 5000lt/Pre-fabricate compension tank 5000lt	€ 2.960,00
ADSALT2100	Sterilizzatore Aqua Salt 100mc + pH/ Aqua Salt Steriliser 100mc + pH	€ 1.840,00
ADPS200	Pannello dosaggio pH - CL/Dosing panel pH-cl	€ 2.726,20
700800305	Pompa di calore 2HP/Heat pump 2HP	€ 2.816,00
KCIT103	Copertura invernale completa/Winter covering	€ 757,00
KCIT111	Copertura invernale completa con scala romana R 1,5/Winter covering roman ladder R1.5	€ 980,00
KCIT119	Copertura invernale completa con scala rett. 1,6x2,4/Winter covering rett ladder 1.6x2.4	€ 930,00
200300014	Lampada LED multicolor/Multi coloured LED lamp	€ 367,65
200300013	Lampada LED bianca/White LED lamp	€ 220,00



## APPROFONDIMENTI/ DETAILS

<http://aqua.quickris.com/pool-kit-mt-5-00x10-00-tipo-a2/>



## QR code

Fotografa il codice con lo smartphone e vai direttamente all'approfondimento

Scan the code with your smartphone to obtain more detailed information



## PUBBLICA TIPO A2

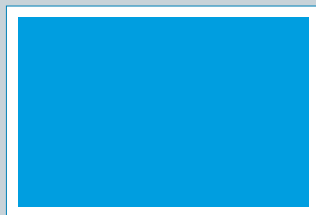

A2



## POOL KIT mt 6.00x12.00 - Tipo A2

piscine ad uso collettivo, inserite in strutture adibite principalmente ad altre attività ricettive o al servizio della collettività (alberghi, agriturismo, campeggi, palestre, scuole, caserme, etc.)

## POOL KIT 6.00X12.00 m - Type A2

pools for collective use, installed in facilities mainly offering other hospitality or public services (hotels, farm holiday houses, camping sites, gyms, schools, army barracks, etc.).

Codice Code	Altezza pannelli altezza acqua Panel height - Water height	Scala recessa Roman steps	Perimetro Perimeter	Area Surface	Volume Volume	Rivestimento in rotoli h 1.65 Azzurro Pool lining - rolls h.1.65, Light Blue	Rivestimento mq. Azzurro antiscivolo Pool lining sq. m Light Blue, non-slip	Filtrazione mc/h v 35 Filtration cu. m/h v.35	Consumo in kw Consumption in kW	Aqua flex tubo rotoli mt 25 Aqua flex pipe, 25 m rolls	Vasca di compenso m <sup>3</sup> Compensation tank cu. m	Aspirafango Mud suction nozzle	N° bocchette No. of nozzles	N° presa di f. No. of main drains	N° fari led bianchi e blue No. of white and blue LED lights	Listino Price List
KABZA112	123		36.00	72.00	88.56	4½		22x2	1.1x3	4	10	1	4	2	3	€ 35.385,00
KABZA113	123	R 1.5	38.46	76.66	94.30	5	8.25	22x2	1.1x3	4	10	1	4	2	3	€ 39.190,00
KABZA114	123	1.6x2.4	39.20	75.84	93.29	5	8.25	22x2	1.1x3	4	10	1	4	2	3	€ 38.810,00
KABZA115	133		36.00	72.00	95.76	4½		22x2	1.1x3	4	10	1	4	2	3	€ 36.855,00
KABZA116	133	R 1.5	38.46	76.66	101.96	5	8.25	22x2	1.1x3	4	10	1	4	2	3	€ 40.650,00
KABZA117	133	1.6x2.4	39.20	75.84	100.87	5	8.25	22x2	1.1x3	4	10	1	4	2	3	€ 40.385,00



## OPTIONAL

Codice/Code	Descrizione/Description	Price
107101702	Vasca di compenso prefabbricata completa 10.000lt/Complete pre-fabricate compension tank 10.000lt	€ 5.730,00
ADSALT2100	Sterilizzatore Aqua Salt 100mc + pH/ Aqua Salt Steriliser 100mc + pH	€ 1.840,00
ADPS200	Pannello dosaggio pH-cl/Dosing panel pH-cl	€ 2.726,20
700800306	Pompa di calore 2,5HP/Heat pump 2,5HP	€ 3.639,00
KCIT105	Copertura invernale completa/Complete winter covering	€ 960,00
KCIT113	Copertura invernale completa con scala romana R 1,5/Winter covering roman ladder R1.5	€ 1230,00
KCIT121	Copertura invernale completa con scala rett. 1,6x2,4/Winter covering rett ladder 1.6x2.4	€ 1166,00
200300014	Lampada LED multicolor/Multi coloured LED lamp	€ 367,65
200300005	Lampada LED bianca/White LED lamp	€ 220,00



## APPROFONDIMENTI/ DETAILS

<http://aqua.quickris.com/pool-kit-mt-6-00x12-00-tipo-a2/>



## QR code

Fotografa il codice con lo smartphone e vai direttamente all'approfondimento

Scan the code with your smartphone to obtain more detailed information

## PUBBLICA TIPO A2

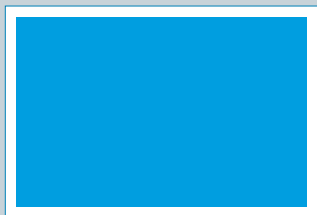

A2



## POOL KIT mt 7.00x14.00 - Tipo A2

piscine ad uso collettivo, inserite in strutture adibite principalmente ad altre attività ricettive o al servizio della collettività (alberghi, agriturismi, campeggi, palestre, scuole, caserme, etc.)

## POOL KIT 7.00x14.00 m - Type A2

pools for collective use, installed in facilities mainly offering other hospitality or public services (hotels, farm holiday houses, camping sites, gyms, schools, army barracks, etc.).

Codice Code	Altezza pannelli altezza acqua Panel height - Water height	Perimetro Perimeter	Area Surface	Volume Volume	Rivestimento in rotoli h 1.65 Azzurro Pool lining - rolls h 1.65, Light Blue	Filtrazione mc/h v 35 Filtration cu. m/h v. 35	Consumo in kw Consumption in kW	Aqua flex tubo rotoli mt 25 Aqua flex pipe, 25 m rolls	Vasca di compenso m <sup>3</sup> Compensation tank cu. m	Aspirafango Mud suction nozzle	N° bocchette No. of nozzles	N° presa di f. No. of main drains	N° fari led bianchi e blue No. of white and blue LED lights	Listino Price List
KABZA118	123	42.00	98.00	120.54	6	22x2	1.1x3	5	10	1	6	2	4	€ 42.610,00
KABZA119	133	42.00	98.00	130.34	6	22x2	1.1x3	5	10	1	6	2	4	€ 44.300,00



## OPTIONAL

Codice/Code	Descrizione/Description	Price
107101702	Vasca di compenso prefabbricata completa 10.000lt/Complete pre-fabbricate compension tank 10.000lt	€ 5.730,00
700800307	Pompa di calore 3,0HP/Heat pump 3.0HP	€ 4.144,00
ADSALT2150	Sterilizzatore Aqua Salt 150mc + pH/Aqua Salt Steriliser 150mc + pH	€ 2.190,00
ADPS201	Pannello dosaggio pH-cl/Dosing panel pH-cl	€ 2.774,94
KCIT107	Copertura completa invernale/Complete winter covering	€ 1185,00
KCIT115	Copertura invernale completa con scala romana R 1,5/Winter covering roman ladder R1.5	€ 1.510,00
KCIT123	Copertura invernale completa con scala rett. 1,6x2,4/Winter covering rett ladder 1.6x2.4	€ 1.437,00
200300014	Lampada LED multicolor/Multi coloured LED lamp	€ 367,65
200300013	Lampada LED bianca/White LED lamp	€ 220,00



## APPROFONDIMENTI/ DETAILS

<http://aqua.quickris.com/pool-kit-mt-7-00x14-00-tipo-a2/>



## QR code

Fotografa il codice con lo smartphone e vai direttamente all'approfondimento

Scan the code with your smartphone to obtain more detailed information

## PUBBLICA TIPO A2

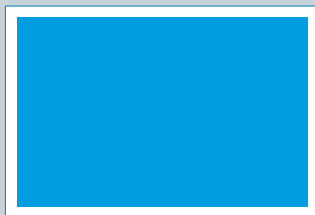

A2

## POOL KIT mt 8.00x16.00 - Tipo A2

piscine ad uso collettivo, inserite in strutture adibite principalmente ad altre attività ricettive o al servizio della collettività (alberghi, agriturismo, campeggi, palestre, scuole, caserme, etc.)



## POOL KIT 8.00x16.00 m - Type A2

pools for collective use, installed in facilities mainly offering other hospitality or public services (hotels, farm holiday houses, camping sites, gyms, schools, army barracks, etc.).

Codice Code	Altezza pannelli altezza acqua Panel height - Water height	Perimetro Perimeter	Area Surface	Volume Volume	Rivestimento in rotoli h 1.65 Azzurro Pool lining - rolls h 1.65, Light Blue	Filtrazione mc/h v 35 Filtration cu. m/h v 35	Consumo in kw Consumption in kW	Aqua flex tubo rotoli mt 25 Aqua flex pipe, 25 m rolls	Vasca di compenso m <sup>3</sup> Compensation tank cu. m	Aspirafango Mud suction nozzle	N° bocchette No. of nozzles	N° presa di f. No. of main drains	N° fari led bianchi e blue No. of white and blue LED lights	Listino Price List
KABZA120	123	48.00	128.00	157,44	6½	33.8x2	2.2x3	6	10	1	8	2	6	€ 75.955,00
KABZA121	133	48.00	128.00	170,24	6½	33.8x2	2.2x3	6	10	1	8	2	6	€ 77.920,00



## OPTIONAL

Codice/Code	Descrizione/Description	Price
107101702	Vasca di compenso prefabbricata 10.000 Lt/Pre-fabricated compensation tank 10000 Lt	€ 5.730,00
ADSALT2200	Sterilizzatore Aqua Salt 200mc + pH/ Aqua Salt Steriliser 200mc + pH	€ 2.500,00
ADPS201	Pannello dosaggio pH - cl/Dosing panel pH-cl	€ 2.774,94
200300014	Lampada LED multicolor/Multi coloured LED lamp	€ 367,65
200300013	Lampada LED bianca/White LED lamp	€ 220,00



## APPROFONDIMENTI/ DETAILS

<http://aqua.quickris.com/pool-kit-mt-8-00x16-00-tipo-a2/>



## QR code

Fotografa il codice con lo smartphone e vai direttamente all'approfondimento

Scan the code with your smartphone to obtain more detailed information



## PUBBLICA TIPO A2

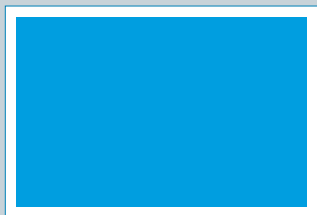

A2



## POOL KIT mt 10.00x20.00 - Tipo A2

piscine ad uso collettivo, inserite in strutture adibite principalmente ad altre attività ricettive o al servizio della collettività (alberghi, agriturismi, campeggi, palestre, scuole, caserme, etc.)

## POOL KIT 10.00x20.00 m - Type A2

pools for collective use, installed in facilities mainly offering other hospitality or public services (hotels, farm holiday houses, camping sites, gyms, schools, army barracks, etc.).

Codice Code	Altezza pannelli altezza acqua Panel height - Water height	Perimetro Perimeter	Area Surface	Volume Volume	Rivestimento in rotoli h 1.65 Azzurro Pool lining - rolls h 1.65, Light Blue	Filtrazione mc/h v 35 Filtration cu. m/h v 35	Consumo in kw Consumption in kW	Aqua flex tubo rotoli mt 25 Aqua flex pipe, 25 m rolls	Vasca di compenso m <sup>3</sup> Compensation tank cu. m	Aspirafango Mud suction nozzle	N° bocchette No. of nozzles	N° presa di f. No. of main drains	N° fari led bianchi e blue No. of white and blue LED lights	Listino Price List
KABZA122	123	60.00	200.00	246.00	9	53.6x2	4x3	6	10x2	1	10	2	8	€ 96.150,00
KABZA123	133	60.00	200.00	266.00	9	53.6x2	4x3	6	10x2	1	10	2	8	€ 98.560,00



## OPTIONAL

Codice/Code	Descrizione/Description	Price
107101702	Vasca di compenso prefabbricata 10.000 Lt/Pre-fabricated compensation tank 10.000 Lt	€ 5.730,00
ADPS201	Pannello dosaggio pH-cl/Dosing panel pH-cl	€ 2.774,94
200300005	Lampada LED multicolor/Multi coloured LED lamp	€ 367,65
200300003	Lampada LED bianca/White LED lamp	€ 220,00



## APPROFONDIMENTI/ DETAILS

<http://aqua.quickris.com/pool-kit-mt-10-00x20-00-tipo-a2/>



## QR code

Fotografa il codice con lo smartphone e vai direttamente all'approfondimento

Scan the code with your smartphone to obtain more detailed information

## PUBBLICA TIPO A2



A2



## POOL KIT mt 4.00x8.00 Orione - Tipo A2

piscine ad uso collettivo, inserite in strutture adibite principalmente ad altre attività ricettive o al servizio della collettività (alberghi, agriturismi, campeggi, palestre, scuole, caserme, etc.)

## POOL KIT 4.00x8.00 m Orione - Type A2

pools for collective use, installed in facilities mainly offering other hospitality or public services (hotels, farm holiday houses, camping sites, gyms, schools, army barracks, etc.).

Codice Code	Altezza pannelli altezza acqua Panel height - Water height	Perimetro Perimeter	Area Surface	Volume Volume	Rivestimento in rotoli h 1.65 Azzurro Pool lining - rolls h 1.65, Light Blue	Filtrazione mc/h v 35 Filtration cu. m/h v 35	Consumo in kw Consumption in kW	Aqua flex tubo rotoli mt 25 Aqua flex pipe, 25 m rolls	Vasca di compenso m <sup>3</sup> Compensation tank cu. m	Aspirafango Mud suction nozzle	N° bocchette No. of nozzles	N° presa di f. No. of main drains	N° fari led bianchi e blue No. of white and blue LED lights	Listino Price List
KABZ124	123	22.28	30.28	37.25	2½	9.00x2	0.50x3	3	3.5	1	2	2	2	€ 24.260,00
KABZ125	133	22.28	30.28	40.28	2½	9.00x2	0.50x3	3	3.5	1	2	2	2	€ 25.015,00



## OPTIONAL

Codice/Code	Descrizione/Description	Price
107101700	Vasca di compenso prefabbricata completa 3.600lt/Complete pre-fabricated compensation tank 3.600lt	€ 2.370,00
ADSALT2050	Sterilizzatore Aqua Salt 50mc + pH/ Aqua Salt Steriliser 50mc + pH	€ 1.700,00
ADPS200	Pannello dosaggio pH - cl/Dosing panel pH-cl	€ 2.726,20
700800304	Pompa di calore 1,5HP/Heat pump 1.5HP	€ 2.256,00
KCIT124	Copertura invernale completa/Complete winter covering	€ 706,00
200300014	Lampada LED multicolor/Multi coloured LED lamp	€ 367,65
200300013	Lampada LED bianca/White LED lamp	€ 220,00



## APPROFONDIMENTI/ DETAILS

<http://aqua.quickris.com/pool-kit-mt-4-00x8-00-orione-tipo-a2/>



## QR code

Fotografa il codice con lo smartphone e vai direttamente all'approfondimento

Scan the code with your smartphone to obtain more detailed information

## PUBBLICA TIPO A2

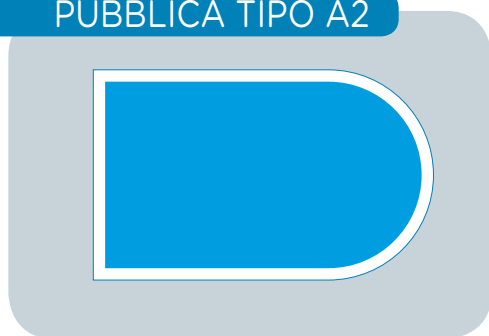

A2



## POOL KIT mt 5.00x10.00 Orione - Tipo A2

piscine ad uso collettivo, inserite in strutture adibite principalmente ad altre attività ricettive o al servizio della collettività (alberghi, agriturismi, campeggi, palestre, scuole, caserme, etc.)

## POOL KIT 5.00X10.00 m ORIONE - Type A2

pools for collective use, installed in facilities mainly offering other hospitality or public services (hotels, farm holiday houses, camping sites, gyms, schools, army barracks, etc.).

Codice Code	Altezza pannelli altezza acqua Panel height - Water height	Perimetro Perimeter	Area Surface	Volume Volume	Rivestimento in rotoli h 1.65 Azzurro Pool lining - rolls h 1.65, Light Blue	Filtrazione mc/h v 35 Filtration cu. m/h v. 35	Consumo in kw Consumption in kW	Aqua flex tubo rotoli mt 25 Aqua flex pipe, 25 m rolls	Vasca di compenso m <sup>3</sup> Compensation tank cu. m	Aspirafango Mud suction nozzle	N° bocchette No. of nozzles	N° presa di f. No. of main drains	N° fari led bianchi e blue No. of white and blue LED lights	Listino Price List
KABZA126	123	27.85	47.32	58.21	3½	15x2	1.1x3	4	5	1	3	2	2	€ 30.855,00
KABZA127	133	27.85	47.32	62.94	3½	15x2	1.1x3	4	5	1	3	2	2	€ 31.790,00

## OPTIONAL

Codice/Code	Descrizione/Description	Price
107101701	Vasca di compenso prefabbricata completa 5.000lt/Complete pre-fabricated compensation tank 5.000lt	€ 2.460,00
ADSALT4100	Sterilizzatore Aqua Salt 100Mc + pH/ Aqua Salt Steriliser 100Mc + pH	€ 1.840,00
ADPS200	Pannello dosaggio pH-cl/Dosing panel pH-cl	€ 2.726,20
700800305	Pompa di calore 2,0HP/Heat pump 2.0HP	€ 2816,00
KCIT125	Copertura invernale completa/Complete winter covering	€ 946,00
200300005	Lampada LED multicolor/Multi coloured LED lamp	€ 367,65
200300003	Lampada LED bianca/White LED lamp	€ 220,00



## APPROFONDIMENTI/ DETAILS

<http://aqua.quickris.com/pool-kit-mt-5-00x10-00-orione-tipo-a2/>

## QR code

Fotografa il codice con lo smartphone e vai direttamente all'approfondimento

Scan the code with your smartphone to obtain more detailed information



## PUBBLICA TIPO A2



A2



## POOL KIT mt 6.00x12.00 Orione - Tipo A2

piscine ad uso collettivo, inserite in strutture adibite principalmente ad altre attività ricettive o al servizio della collettività (alberghi, agriturismi, campeggi, palestre, scuole, caserme, etc.)

## POOL KIT 6.00x12.00 m Orione - Type A2

pools for collective use, installed in facilities mainly offering other hospitality or public services (hotels, farm holiday houses, camping sites, gyms, schools, army barracks, etc.).

Codice Code	Altezza pannelli altezza acqua Panel height - Water height	Perimetro Perimeter	Area Surface	Volume Volume	Rivestimento in rotoli h 1.65 Azzurro Pool lining - rolls h 1.65, Light Blue	Filtrazione mc/h v 35 Filtration cu. m/h v 35	Consumo in kw Consumption in kW	Aqua flex tubo rotoli mt 25 Aqua flex pipe, 25 m rolls	Vasca di compenso m <sup>3</sup> Compensation tank cu. m	Aspirafango Mud suction nozzle	N° bocchette No. of nozzles	N° presa di f. No. of main drains	N° fari led bianchi e blue No. of white and blue LED lights	Listino Price List
KABZA128	123	33.42	68.14	88.82	4½	15x2	1.1x3	4	10	1	4	2	3	€ 34.740,00
KABZA129	133	33.42	68.14	90.63	4½	15x2	1.1x3	4	10	1	4	2	3	€ 36.230,00



## OPTIONAL

Codice/Code	Descrizione/Description	Price
107101702	Vasca di compenso prefabbricata completa 10.000lt/Complete pre-fabricated compensation tank 10.000lt	€ 5.730,00
ADSALT2100	Sterilizzatore Aqua Salt 100mc + pH/ Aqua Salt Steriliser 100mc + pH	€ 1.840,00
ADPS200	Pannello dosaggio pH - cl/Dosing panel pH - cl	€ 2.726,20
700800305	Pompa di calore 2,0HP/Heat pump 2.0HP	€ 2.816,00
KCIT126	Copertura invernale completa/Complete winter covering	€ 1222,00
200300014	Lampada LED multicolor/Multi coloured LED lamp	€ 367,65
200300013	Lampada LED bianca/White LED lamp	€ 220,00



## APPROFONDIMENTI/ DETAILS

<http://aqua.quickris.com/pool-kit-mt-6-00x12-00-orione-tipo-a2/>



## QR code

Fotografa il codice con lo smartphone e vai direttamente all'approfondimento

Scan the code with your smartphone to obtain more detailed information

## PUBBLICA TIPO A2



A2



## POOL KIT mt 4.00x8.00 Sirio - Tipo A2

piscine ad uso collettivo, inserite in strutture adibite principalmente ad altre attività ricettive o al servizio della collettività (alberghi, agriturismi, campeggi, palestre, scuole, caserme, etc.)

## POOL KIT 4.00X8.00 m SIRIO - Type A2

pools for collective use, installed in facilities mainly offering other hospitality or public services (hotels, farm holiday houses, camping sites, gyms, schools, army barracks, etc.).

Codice Code	Altezza pannelli altezza acqua Panel height - Water height	Perimetro Perimeter	Area Surface	Volume Volume	Rivestimento in rotoli h 1.65 Azzurro Pool lining - rolls h 1.65, Light Blue	Filtrazione mc/h v 35 Filtration cu. m/h v. 35	Consumo in kw Consumption in kW	Aqua flex tubo rotoli mt 25 Aqua flex pipe, 25 m rolls	Vasca di compenso m <sup>3</sup> Compensation tank cu. m	Aspirafango Mud suction nozzle	N° bocchette No. of nozzles	N° presa di f. No. of main drains	N° fari led bianchi e blue No. of white and blue LED lights	Listino Price List
KABZA130	123	20.24	24.64	30.31	2½	9.00x2	0.50x3	3	3.5	1	2	2	1	€ 23.915,00
KABZA131	133	20.24	24.64	32.78	2½	9.00x2	0.50x3	3	3.5	1	2	2	1	€ 24.405,00

 OPTIONAL

Codice/Code	Descrizione/Description	Price
107101700	Vasca di compenso prefabbricata completa 3.600lt/Complete pre-fabricated compensation tank 3.600lt	€ 2370,00
ADSALT2050	Sterilizzatore Aqua Salt 50mc + pH/ Aqua Salt Steriliser 50mc + pH	€ 1700,00
ADPS200	Pannello dosaggio pH-cl/Dosing panel pH-cl	€ 2726,20
700800304	Pompa di calore 1,5HP/Heat pump 1.5HP	€ 2256,00
KCIT127	Copertura invernale completa/Complete winter covering	€ 688,00
200300014	Lampada LED multicolor/Multi coloured LED lamp	€ 367,65
200300013	Lampada LED bianca/White LED lamp	€ 220,00



## APPROFONDIMENTI/ DETAILS

<http://aqua.quickris.com/pool-kit-mt-4-00x8-00-sirio-tipo-a2/>



## QR code

Fotografa il codice con lo smartphone e vai direttamente all'approfondimento

Scan the code with your smartphone to obtain more detailed information

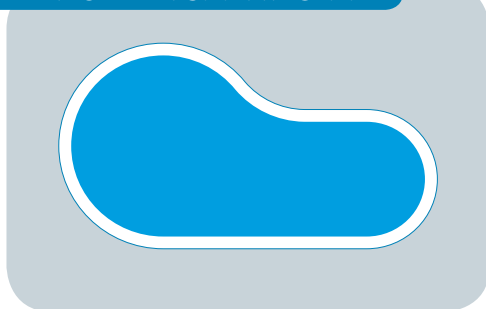

## PUBBLICA TIPO A2



A2

## POOL KIT mt 5.00x10.00 Sirio - Tipo A2

piscine ad uso collettivo, inserite in strutture adibite principalmente ad altre attività ricettive o al servizio della collettività (alberghi, agriturismo, campeggi, palestre, scuole, caserme, etc.)



## POOL KIT 5.00x10.00 m Sirio - Type A2

pools for collective use, installed in facilities mainly offering other hospitality or public services (hotels, farm holiday houses, camping sites, gyms, schools, army barracks, etc.).

Codice Code	Altezza pannelli altezza acqua Panel height - Water height	Perimetro Perimeter	Area Surface	Volume Volume	Rivestimento in rotoli h 1.65 Azzurro Pool lining - rolls h 1.65, Light Blue	Filtrazione mc/h v 35 Filtration cu. m/h v 35	Consumo in kw Consumption in kW	Aqua flex tubo rotoli mt 25 Aqua flex pipe, 25 m rolls	Vasca di compenso m <sup>3</sup> Compensation tank cu. m	Aspirafango Mud suction nozzle	N° bocchette No. of nozzles	N° presa di f. No. of main drains	N° fari led bianchi e blue No. of white and blue LED lights	Listino Price List
KABZA132	123	25.37	39.56	48.66	3	15x2	1.1x3	4	5	1	3	2	2	€ 30.080,00
KABZA133	133	25.37	39.56	52.62	3	15x2	1.1x3	4	5	1	3	2	2	€ 30.700,00



## OPTIONAL

Codice/Code	Descrizione/Description	Price
107101701	Vasca di compenso prefabbricata completa 5.000lt/Complete pre-fabricated compensation tank 5.000lt	€ 2.460,00
ADSALT2100	Sterilizzatore Aqua Salt 100mc + pH/ Aqua Salt Steriliser 100mc + pH	€ 1.840,00
ADPS200	Pannello dosaggio pH - Cl/Dosing panel pH-cl	€ 2726,20
700800305	Pompa di calore 2.0HP/Heat pump 2.0HP	€ 2.816,00
KCIT128	Copertura invernale completa/Complete winter covering	€ 920,00
200300014	Lampada LED multicolor/Multi coloured LED lamp	€ 367,65
200300013	Lampada LED bianca/White LED lamp	€ 220,00



## APPROFONDIMENTI/ DETAILS

<http://aqua.quickris.com/pool-kit-mt-5-00x10-00-sirio-tipo-a2/>



## QR code

Fotografa il codice con lo smartphone e vai direttamente all'approfondimento

Scan the code with your smartphone to obtain more detailed information

## PUBBLICA TIPO A2

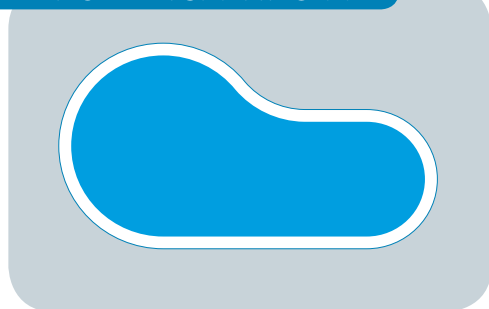

A2



## POOL KIT mt 6.00x12.00 Sirio - Tipo A2

piscine ad uso collettivo, inserite in strutture adibite principalmente ad altre attività ricettive o al servizio della collettività (alberghi, agriturismi, campeggi, palestre, scuole, caserme, etc.)

## POOL KIT 6.00X12.00 m Sirio - Type A2

pools for collective use, installed in facilities mainly offering other hospitality or public services (hotels, farm holiday houses, camping sites, gyms, schools, army barracks, etc.).

Codice Code	Altezza pannelli altezza acqua Panel height - Water height	Perimetro Perimeter	Area Surface	Volume Volume	Rivestimento in rotoli h 1.65 Azzurro Pool lining - rolls h 1.65, Light Blue	Filtrazione mc/h v 35 Filtration cu. m/h v. 35	Consumo in kw Consumption in kW	Aqua flex tubo rotoli mt 25 Aqua flex pipe, 25 m rolls	Vasca di compenso m <sup>3</sup> Compensation tank cu. m	Aspirafango Mud suction nozzle	N° bocchette No. of nozzles	N° presa di f. No. of main drains	N° fari led bianchi e blue No. of white and blue LED lights	Listino Price List
KABZA134	123	30.50	58.06	71.42	4	15x2	1.1x3	4	5	1	4	2	2	€ 33.880,00
KABZA135	133	30.50	58.06	77.22	4	15x2	1.1x3	4	5	1	4	2	2	€ 34.615,00

## OPTIONAL

Codice/Code	Descrizione/Description	Price
107101701	Vasca di compenso prefabbricata completa 5.000lt/Complete pre-fabricated compensation tank 5.000lt	€ 2.460,00
ADSALT2100	Sterilizzatore Aqua Salt 100mc + pH/ Aqua Salt Steriliser 100mc + pH	€ 1.840,00
ADPS200	Pannello dosaggio pH - Cl/Dosing panel pH-cl	€ 2.726,20
700800305	Pompa di calore 2,0HP/Heat pump 2.0HP	€ 2.816,00
KCIT129	Copertura invernale completa/Complete winter covering	€ 1.192,00
200300014	Lampada LED multicolor/Multi coloured LED lamp	€ 367,65
200300013	Lampada LED bianca/White LED lamp	€ 220,00



## APPROFONDIMENTI/ DETAILS

<http://aqua.quickris.com/pool-kit-mt-6-00x12-00-sirio-tipo-a2/>

## QR code

Fotografa il codice con lo smartphone e vai direttamente all'approfondimento

Scan the code with your smartphone to obtain more detailed information

## PUBBLICA TIPO A2

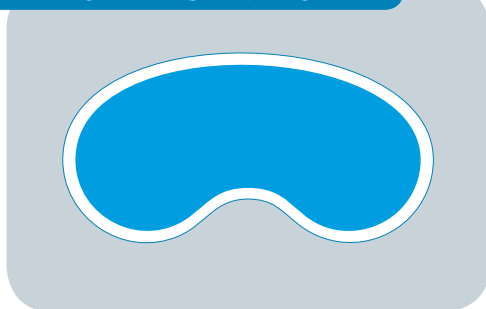

A2



**POOL KIT mt 4.00x 8.00 Andromeda - Tipo A2**  
piscine ad uso collettivo, inserite in strutture adibite principalmente ad altre attività ricettive o al servizio della collettività (alberghi, agriturismi, campeggi, palestre, scuole, caserme, etc.)

*POOL KIT 4.00X 8.00 m Andromeda - Type A2*  
pools for collective use, installed in facilities mainly offering other hospitality or public services (hotels, farm holiday houses, camping sites, gyms, schools, army barracks, etc.).

Codice Code	Altezza pannelli altezza acqua Panel height - Water height	Perimetro Perimeter	Area Surface	Volume Volume	Rivestimento in rotoli h 1.65 Azzurro Pool lining - rolls h 1.65, Light Blue	Filtrazione mc/h v 35 Filtration cu. m/h v 35	Consumo in kw Consumption in kW	Aqua flex tubo rotoli mt 25 Aqua flex pipe, 25 m rolls	Vasca di compenso m <sup>3</sup> Compensation tank cu. m	Aspirafango Mud suction nozzle	N° bocchette No. of nozzles	N° presa di f. No. of main drains	N° fari led bianchi e blue No. of white and blue LED lights	Listino Price List
KABZA136	123	21.00	29.45	36.23	2½	9.0x2	0.50x3	3	3.5	1	2	2	2	€ 26.625,00
KABZA137	133	21.00	29.45	39.17	2½	9.0x2	0.50x3	3	3.5	1	2	2	2	€ 27.420,00



## OPTIONAL

Codice/Code	Descrizione/Description	Price
107101700	Vasca di compenso prefabbricata completa 3.600lt/Complete pre-fabricated compensation tank 3.600lt	€ 2.370,00
ADSALT2050	Sterilizzatore Aqua Salt 50mc + pH/ Aqua Salt Steriliser 50mc + pH	€ 1.700,00
ADPS200	Pannello dosaggio pH - cl/Dosing panel pH-cl	€ 2726,20
700800304	Pompa di calore 1,5HP/Heat pump 1.5HP	€ 2.256,00
KCIT130	Copertura invernale completa/Complete winter covering	€ 706,00
200300014	Lampada LED multicolor/Multi coloured LED lamp	€ 367,65
200300013	Lampada LED bianca/White LED lamp	€ 220,00



## APPROFONDIMENTI/ DETAILS

<http://aqua.quickris.com/pool-kit-mt-4-00x-8-00-andromeda-tipo-a2/>



## QR code

Fotografa il codice con lo smartphone e vai direttamente all'approfondimento

Scan the code with your smartphone to obtain more detailed information



## PUBBLICA TIPO A2

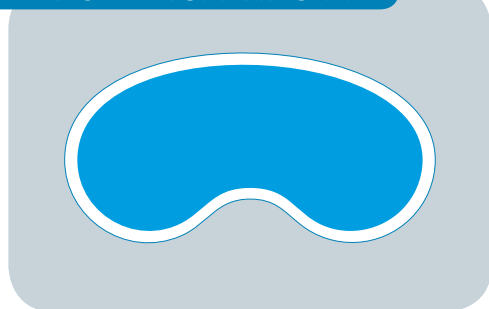

**A2**



**POOL KIT mt 5.00x 10.00 Andromeda - Tipo A2** piscine ad uso collettivo, inserite in strutture adibite principalmente ad altre attività ricettive o al servizio della collettività (alberghi, agriturismi, campeggi, palestre, scuole, caserme, etc.)

*POOL KIT 5.00X 10.00 m Andromeda - Type A2* pools for collective use, installed in facilities mainly offering other hospitality or public services (hotels, farm holiday houses, camping sites, gyms, schools, army barracks, etc.).

Codice Code	Altezza pannelli altezza acqua Panel height - Water height	Perimetro Perimeter	Area Surface	Volume Volume	Rivestimento in rotoli h 1.65 Azzurro Pool lining - rolls h 1.65, Light Blue	Filtrazione mc/h v 35 Filtration cu. m/h v 35	Consumo in kw Consumption in kW	Aqua flex tubo rotoli mt 25 Aqua flex pipe, 25 m rolls	Vasca di compenso m <sup>3</sup> Compensation tank cu. m	Aspirafango Mud suction nozzle	N° bocchette No. of nozzles	N° presa di f. No. of main drains	N° fari led bianchi e blue No. of white and blue LED lights	Listino Price List
KABZA138	123	26.51	46.64	57.37	3 ½	15x2	1.1x3	4	5	1	3	2	2	€ 31.470,00
KABZA139	133	26.51	46.64	62.04	3 ½	15x2	1.1x3	4	5	1	3	2	2	€ 31.945,00

## + OPTIONAL

Codice/Code	Descrizione/Description	Price
107101701	Vasca di compenso prefabbricata completa 5.000lt/Complete pre-fabricated compensation tank 5.000lt	€ 2.460,00
ADSALT2100	Sterilizzatore Aqua Salt 100mc + pH/ Aqua Salt Steriliser 100mc + pH	€ 1.840,00
ADPS200	Pannello dosaggio pH - cl/Dosing panel pH - cl	€ 2.726,20
700800305	Pompa di calore 2,0HP/Heat pump 2.0HP	€ 2.816,00
KCIT131	Copertura invernale completa/Complete winter covering	€ 938,00
200300014	Lampada LED multicolor/Multi coloured LED lamp	€ 367,65
200300013	Lampada LED bianca/White LED lamp	€ 220,00



### APPROFONDIMENTI/ DETAILS

<http://aqua.quickris.com/pool-kit-mt-5-00x-10-00-andromeda-tipo-a2/>



### QR code

Fotografa il codice con lo smartphone e vai direttamente all'approfondimento

Scan the code with your smartphone to obtain more detailed information

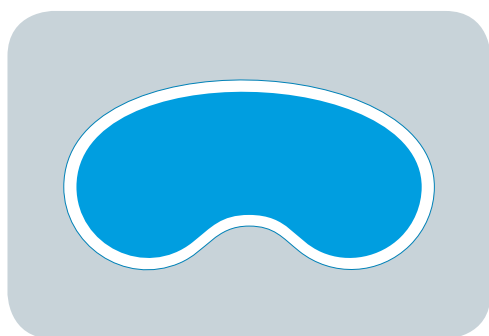

A2



**POOL KIT mt 6.00x 12.00 Andromeda - Tipo A2**  
piscine ad uso collettivo, inserite in strutture adibite principalmente ad altre attività ricettive o al servizio della collettività (alberghi, agriturismi, campeggi, palestre, scuole, caserme, etc.)

*POOL KIT 6.00X 12.00 m Andromeda - Type A2*  
pools for collective use, installed in facilities mainly offering other hospitality or public services (hotels, farm holiday houses, camping sites, gyms, schools, army barracks, etc.).

Codice Code	Altezza pannelli altezza acqua Panel height - Water height	Perimetro Perimeter	Area Surface	Volume Volume	Rivestimento in rotoli h 1.65 Azzurro Pool lining - rolls h 1.65, Light Blue	Filtrazione mc/h v 35 Filtration cu. m/h v 35	Consumo in kw Consumption in kW	Aqua flex tubo rotoli mt 25 Aqua flex pipe, 25 m rolls	Vasca di compenso m <sup>3</sup> Compensation tank cu. m	Aspirafango Mud suction nozzle	N° bocchette No. of nozzles	N° presa di f. No. of main drains	N° fari led bianchi e blue No. of white and blue LED lights	Listino Price List
KABZA140	123	31.98	67.68	83.25	4	22x2	1.1x3	4	5	1	4	2	3	€ 36.035,00
KABZA141	133	31.98	67.68	90.02	4	22x2	1.1x3	4	5	1	4	2	3	€ 37.110,00



## OPTIONAL

Codice/Code	Descrizione/Description	Price
107101702	Vasca di compenso prefabbricata completa 10.000lt/Complete pre-fabricated compensation tank 10.000lt	€ 5.730,00
ADSALT2100	Sterilizzatore Aqua Salt 100mc + pH/ Aqua Salt Steriliser 100mc + pH	€ 1.840,00
ADPS200	Pannello dosaggio pH - cl/Dosing panel pH-cl	€ 2726,20
700800305	Pompa di calore 2,0HP/Heat pump 2.0HP	€ 2.816,20
KCIT132	Copertura invernale completa/Complete winter covering	€ 1210,00
200300014	Lampada LED multicolor/Multi coloured LED lamp	€ 367,65
200300013	Lampada LED bianca/White LED lamp	€ 220,00



## APPROFONDIMENTI/ DETAILS

<http://aqua.quickris.com/pool-kit-mt-6-00x-10-00-andromeda-tipo-a2/>



## QR code

Fotografa il codice con lo smartphone e vai direttamente all'approfondimento

Scan the code with your smartphone to obtain more detailed information

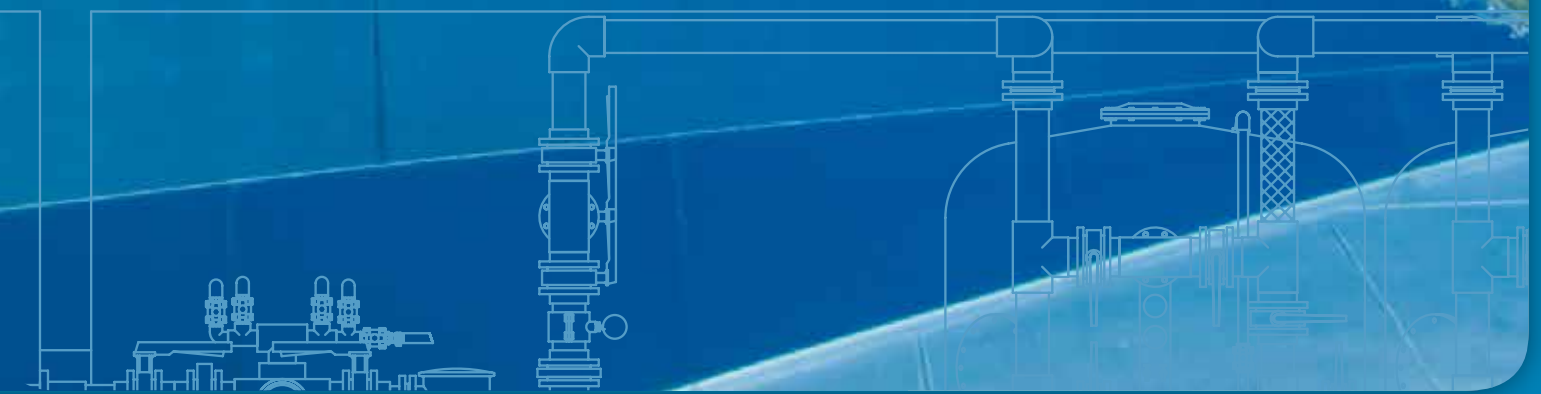
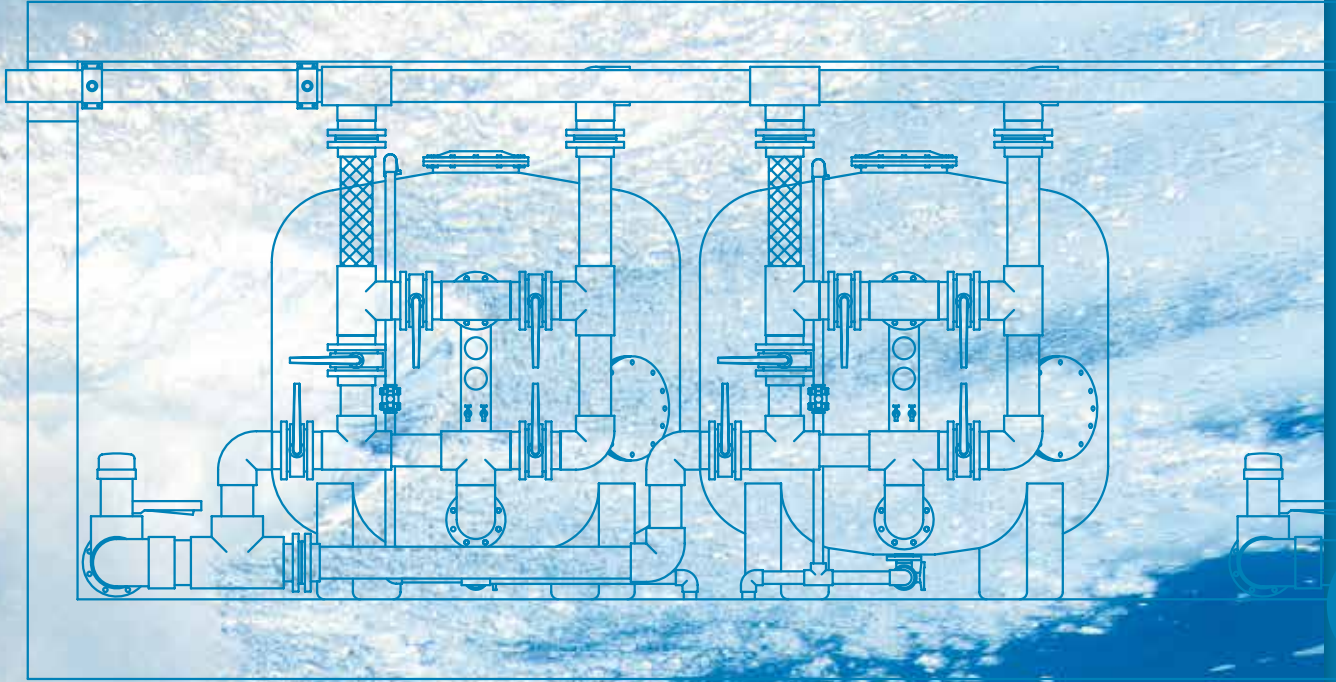



## PUBBLICA TIPO B

B

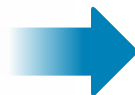

## PUBBLICA - TIPO B - BORDO SFIORO

PUBLIC - TYPE B - OVERFLOW EDGE



## CAMPO DI UTILIZZO

Piscine condominiali: destinate esclusivamente agli abitanti del condominio ed ai loro ospiti, con esclusione delle piscine al servizio di edifici abitativi sino a quattro condomini.



## CONTEXT OF USE

Condominium swimming pools: intended only for resident of the apartment building and their guests, except for the pools at the service to residential building up to four condominiums.



## CARATTERISTICHE TECNICHE

## 1) STRUTTURA

Tecnologia a Bordo Sfiatore H 120cm +3(bsf) 130cm +3(bsf)  
Altezza Aqua > 140cm necessita presenza del bagnino  
Tempi di filtrazione differenti a seconda dell'altezza di Aqua  
(vedi tab. pag 135)

## 2) RIVESTIMENTO

PVC armato

## 3) CIRCOLAZIONE

L'immissione in vasca può avvenire dalle pareti o dal fondo, purché si garantisca l'omogeneizzazione.

I sistemi di ripresa immersi e le prese di fondo devono essere sempre collegate in coppia ad una distanza minima di 2 mt.

## 4) FILTRAZIONE

- Diametro minimo Ø 500mm
- Altezza minima Ø 1000mm
- Altezza minima letto filtrante Ø 600mm
- Velocità di filtrazione δ40mc/h
- Pressione di collaudo deve essere ε1,5volte superiore alla pressione massima di esercizio.
- Pressione massima di esercizio con un minimo di 350Kpa.
- Deve essere previsto un numero di filtri ≥1; tutti i filtri devono avere medesime caratteristiche
- Deve essere previsto un numero minimo di pompe, tante quante sono i filtri più 1 di scorta.
- Devono essere previsti minimo 5 punti di lettura.

## 5) ILLUMINAZIONE

- Led

## 6) QUADRO ELETTRICO

- Trifasi



## TECHNICAL FEATURES

## 1) STRUCTURE

Overflow technology H 120cm +3(ovf) 130cm +3(ovf)  
Water height > 140cm need the presence of the lifeguard  
Filtration time different depending on the water height (see tab. page 135)

## 2) COATING

Reinforced PVC

## 3) CIRCULATION

The return of the water in the pool can be from the wall or from the bottom, provided it is ensure homogenization.

The suction of the swimming pool and the main drain must always be connected in pairs at a minimum distance of 2 meters.

## 4) FILTRATION

- Minimum Diameter Ø 500mm
- Minimum height Ø 1000mm
- Minimum height filtration material Ø 600mm
- Filtration speed δ40mc/h
- Pressure test must be ε1,5 time higher than the maximum pressure.
- Maximum with a minimum of 350Kpa.
- Must be provided a minimum number of filters ≥1; all the filters must have the same characteristic
- Must be provided a minimum number of pumps, as many filters plus 1 spare.
- Must be provided at least 5 check points.

## 5) LIGHTING

- Led

## 6) ELECTRICAL BOARD

- Three-phase



**NORMATIVE**

Normativa NTC 2008 - L. n°1086 del 05.11.1971: "Norme per la disciplina delle opere in conglomerato cementizio armato, normale e precompresso e in struttura metallica";  
Ordinanza n°3274 del 20.03.2003: "Primi elementi in materia di criteri generali per la classificazione sismica del territorio nazionale e di normative tecniche per la costruzione in zona sismica";  
D.M. del 14.01.2008: "Norme Tecniche per le costruzioni NTC 2008";  
Circolare ministeriale n°617 del 27.02.2009: "Istruzioni per l'applicazione delle Norme Tecniche per le Costruzioni";  
EC3: EUROCODICE 3 EN 1993 1-3; 1-5; 1-2.  
Carichi e movimentazione D. Lgs. 81/08 (ex 626). (MAX KG.30)  
UNI EN 10637:2006  
UNI EN 13451-1:2002 e 13451-3:2002  
UNI EN 13451-1:2002 e 13451-1:2002

**STANDARDS**

NTC 2008 Standard - Italian Law no. 1086 of 05.11.1971: "Regulations for works in reinforced concrete, pre-stressed reinforced concrete and metal structures";  
Italian Order no.3274 of 20.03.2003: "Basic notions on general seismic classification criteria for the national territory and technical rules for construction in seismic areas";  
Italian Ministerial Decree of 14.01.2008: "Technical Standards for Construction NTC 2008";  
Italian Ministerial Circular no. 617 of 27.02.2009: "Instructions for the application of Technical Standards for Construction";  
EC3: EUROCODE 3 EN 1993 1-3; 1-5; 1-2. Loads and handling - Italian Legislative Decree 81/08 (ex 626). (MAX KG.30)  
UNI EN 10637:2006  
UNI EN 13451-1:2002 and 13451-3:2002  
UNI EN 13451-1:2002 and 13451-1:2002

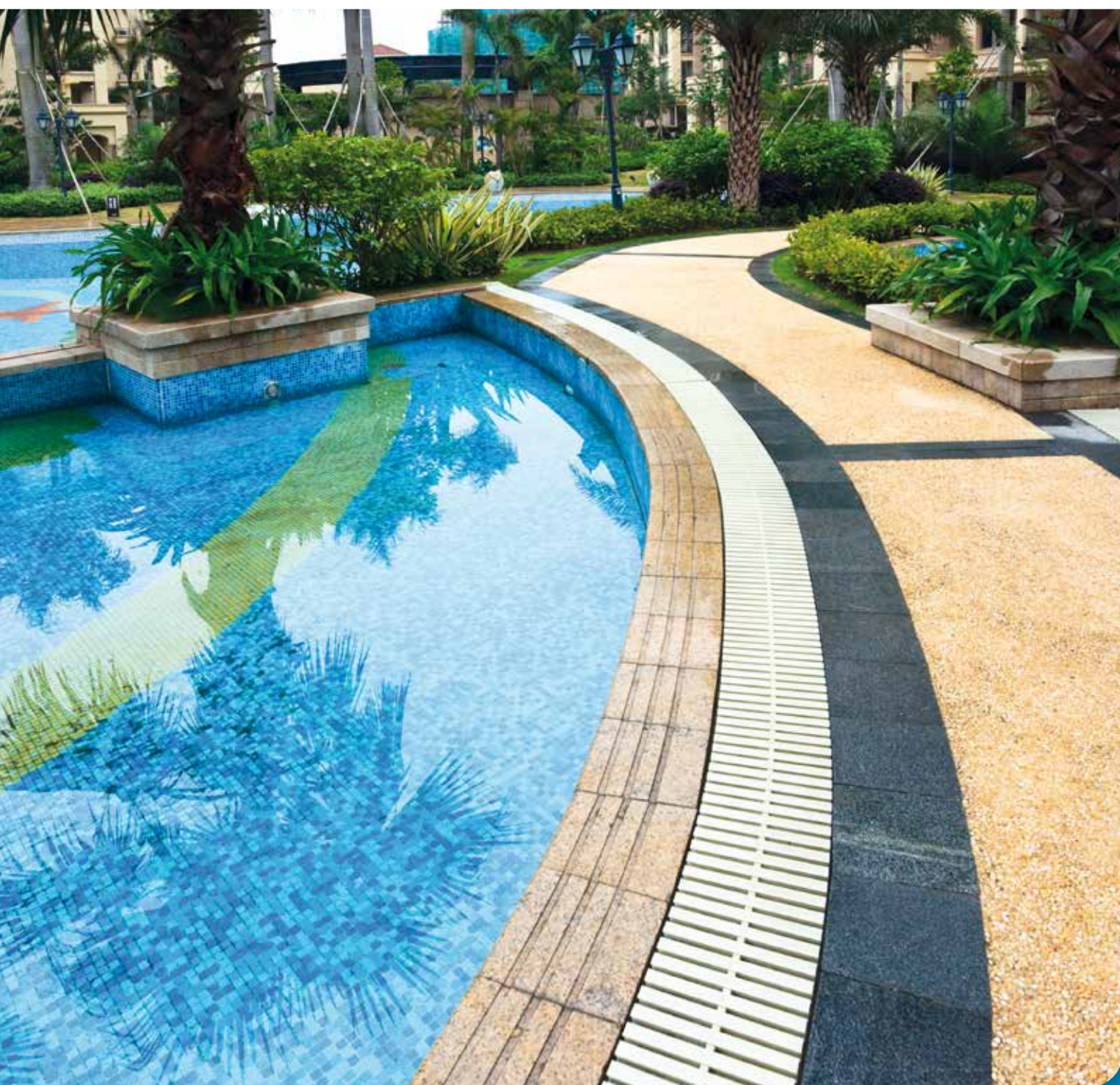

## PUBBLICA TIPO B

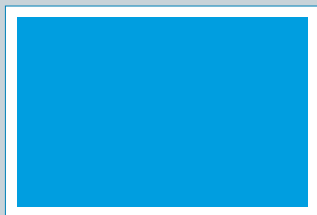

## POOL KIT mt 4.00x8.00 - Tipo B

piscine condominiali, destinate all'uso esclusivo degli abitanti del condominio e dei loro ospiti, esclusi i condomini fino a 4 unità abitative



## POOL KIT 4.00x8.00 m - Type B

condominium pools, exclusively used by the inhabitants of a block of flats and their guests, excluding blocks of flats up to 4 apartments

Codice Code	Altezza pannelli altezza acqua Panel height - Water height	Scala recessa Roman steps	Perimetro Perimeter	Area Surface	Volume Volume	Rivestimento in rotoli h 1.65 Azzurro Pool lining - rolls h.1.65, Light Blue	Rivestimento mq. Azzurro antiscivolo Pool lining sq. m Light Blue, non-slip	Filtrazione mc/h v 40 Filtration cu. m/h v. 40	Consumo in kw Consumption in kW	Aqua flex tubo rotoli mt.25 Aqua flex pipe, 25 m rolls	Vasca di compenso m <sup>3</sup> Compensation tank cu. m	Aspirafango Mud suction nozzle	N° bocchette No. of nozzles	N° presa di f. No. of main drains	N° fari led bianchi e blue No. of white and blue LED lights	Listino Price List
KBBZA100	123		24.00	32.00	39.36	2½		10	0.75x2	3	3.5	1	2	2	2	€ 20.415,00
KBBZA101	123	R 1.5	26.46	36.66	45.10	3	8.25	17	1.1x2	3	3.5	1	2	2	2	€ 24.965,00
KBBZA102	123	1.6x2.4	27.20	35.84	44.09	3	8.25	17	1.1x2	3	3.5	1	2	2	2	€ 24.780,00
KBBZA103	133		24.00	32.00	42.56	2½		17	1.1x2	3	3.5	1	2	2	2	€ 23.170,00
KBBZA104	133	R 1.5	26.46	36.66	48.76	3	8.25	17	1.1x2	3	3.5	1	2	2	2	€ 25.960,00
KBBZA105	133	1.6x2.4	27.20	35.84	47.67	3	8.25	17	1.1x2	3	3.5	1	2	2	2	€ 25.890,00



## OPTIONAL

Codice/Code	Descrizione/Description	Price
107101700	Vasca di compenso prefabbricata completa 3.600lt/Complete pre-fabricated compensation tank 3.600lt	€ 2.460,00
ADSALT2050	Sterilizzatore Aqua Salt 50mc + pH/ Aqua Salt Steriliser 50mc + pH	€ 1.700,00
ADPS200	Pannello dosaggio pH - cl/Dosing panel pH-cl	€ 2726,20
700800304	Pompa di calore 1,5HP/Heat pump 1.5HP	€ 2.256,00
KCIT101	Copertura invernale completa/Complete winter covering	€ 580,00
KCIT109	Copertura invernale completa con scala romana R 1,5/Complete winter covering roman ladder R1.5	€ 753,00
KCIT117	Copertura invernale completa con scala rett 1,6x2,4/Complete winter covering rett ladder 1.6x2.4	€ 720,00
200300014	Lampada LED multicolor/Multi coloured LED lamp	€ 3567,65
200300013	Lampada LED bianca/White LED lamp	€ 220,00



## APPROFONDIMENTI/ DETAILS

<http://aqua.quickris.com/pool-kit-mt-4-00x8-00-tipo-b/>



## QR code

Fotografa il codice con lo smartphone e vai direttamente all'approfondimento

Scan the code with your smartphone to obtain more detailed information



## PUBBLICA TIPO B

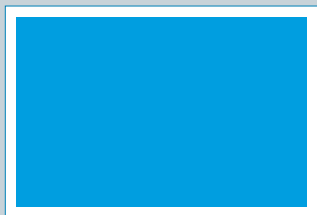

## POOL KIT mt 5.00x10.00 - Tipo B

piscine condominiali, destinate all'uso esclusivo degli abitanti del condominio e dei loro ospiti, esclusi i condomini fino a 4 unità abitative



## POOL KIT 5.00X10.00 m - Type B

condominium pools, exclusively used by the inhabitants of a block of flats and their guests, excluding blocks of flats up to 4 apartments

Codice Code	Altezza pannelli altezza acqua Panel height - Water height	Scala recessa Roman steps	Perimetro Perimeter	Area Surface	Volume Volume	Rivestimento in rotoli h 1.65 Azzurro Pool lining - rolls h.1.65, Light Blue	Rivestimento mq. Azzurro antiscivolo Pool lining sq. m Light Blue, non-slip	Filtrazione mc/h v 40 Filtration cu. m/h v. 40	Consumo in kW Consumption in kW	Aqua flex tubo rotoli mt 25 Aqua flex pipe, 25 m rolls	Vasca di compenso m <sup>3</sup> Compensation tank cu. m	Aspirafango Mud suction nozzle	N° bocchette No. of nozzles	N° presa di f. No. of main drains	N° fari led bianchi e blue No. of white and blue LED lights	Listino Price List
KBBZA106	123		30.00	50.00	61.50	3½		17	1.1x2	4	3.5	1	3	2	2	€ 26.530,00
KBBZA107	123	R 1.5	32.46	54.66	67.24	4	8.25	17	1.1x2	4	3.5	1	3	2	2	€ 29.485,00
KBBZA108	123	1.6x2.4	33.20	53.84	66.23	4	8.25	17	1.1x2	4	3.5	1	3	2	2	€ 29.095,00
KBBZA109	133		30.00	50.00	66.50	3½		17	1.1x2	4	3.5	1	3	2	2	€ 27.730,00
KBBZA110	133	R 1.5	32.46	54.66	72.70	4	8.25	25	1.5x2	4	3.5	1	3	2	2	€ 31.020,00
KBBZA111	133	1.6x2.4	33.20	53.84	71.61	4	8.25	25	1.5x2	4	3.5	1	3	2	2	€ 30.745,00



## OPTIONAL

Codice/Code	Descrizione/Description	Price
107101701	Vasca di compenso prefabbricata completa 5.000lt/Complete pre-fabricated compensation tank 5.000lt	€ 2.460,00
ADSALT2100	Sterilizzatore Aqua Salt 100mc + pH/ Aqua Salt Steriliser 100mc + pH	€ 1.840,00
ADPS200	Pannello dosaggio pH - cl/Dosing panel pH-cl	€ 2.726,20
700800305	Pompa di calore 2,0HP/Heat pump 2.0HP	€ 2.816,00
KCIT103	Copertura invernale completa/Complete winter covering	€ 757,00
KCIT111	Copertura invernale completa con scala romana R 1,5/Complete winter covering roman ladder R1.5	€ 980,00
KCIT119	Copertura invernale completa con scala rett 1,6x2,4/Complete winter covering rett ladder 1.6x2.4	€ 930,00
200300014	Lampada LED multicolor/Multi coloured LED lamp	€ 367,65
200300013	Lampada LED bianca/White LED lamp	€ 220,00



## APPROFONDIMENTI/ DETAILS

<http://aqua.quickris.com/pool-kit-mt-5-00x10-00-tipo-b/>



## QR code

Fotografa il codice con lo smartphone e vai direttamente all'approfondimento

Scan the code with your smartphone to obtain more detailed information

## PUBBLICA TIPO B

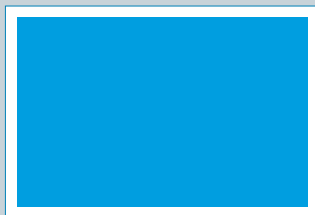

## POOL KIT mt 6.00x12.00 - Tipo B

piscine condominiali, destinate all'uso esclusivo degli abitanti del condominio e dei loro ospiti, esclusi i condomini fino a 4 unità abitative



## POOL KIT 6.00x12.00 m - Type B

condominium pools, exclusively used by the inhabitants of a block of flats and their guests, excluding blocks of flats up to 4 apartments

Codice Code	Altezza pannelli altezza acqua Panel height - Water height	Scala recessa Roman steps	Perimetro Perimeter	Area Surface	Volume Volume	Rivestimento in rotoli h 1.65 Azzurro Pool lining - rolls h.1.65, Light Blue	Rivestimento mq. Azzurro antiscivolo Pool lining sq. m Light Blue, non-slip	Filtrazione mc/h v 40 Filtration cu. m/h v. 40	Consumo in kw Consumption in kW	Aqua flex tubo rotoli mt.25 Aqua flex pipe, 25 m rolls	Vasca di compenso m <sup>3</sup> Compensation tank cu. m	Aspirafango Mud suction nozzle	N° bocchette No. of nozzles	N° presa di f. No. of main drains	N° fari led bianchi e blue No. of white and blue LED lights	Listino Price List
KBBZA112	123		36.00	72.00	88.56	4½		25	1.5x2	4	10	1	4	2	3	€ 29.465,00
KBBZA113	123	R 1.5	38.46	76.66	94.30	5	8.25	25	1.5x2	4	10	1	4	2	3	€ 34.210,00
KBBZA114	123	1.6x2.4	39.20	75.84	93.29	5	8.25	25	1.5x2	4	10	1	4	2	3	€ 33.835,00
KBBZA115	133		36.00	72.00	95.76	4½		25	1.5x2	4	10	1	4	2	3	€ 31.885,00
KBBZA116	133	R 1.5	38.46	76.66	101.96	5	8.25	34	1.1x3	4	10	1	4	2	3	€ 40.225,00
KBBZA117	133	1.6x2.4	39.20	75.84	100.87	5	8.25	34	1.1x3	4	10	1	4	2	3	€ 39.985,00



## OPTIONAL

Codice/Code	Descrizione/Description	Price
107101702	Vasca di compenso prefabbricata completa 10.000lt/Complete pre-fabricated compensation tank 10.000lt	€ 5.730,00
ADSALT2100	Sterilizzatore Aqua Salt 100mc + pH/ Aqua Salt Steriliser 100mc + pH	€ 1.840,00
ADPS200	Pannello dosaggio pH - cl/Dosing panel pH-cl	€ 2.726,20
700800306	Pompa di calore 2,5HP/Heat pump 2.5HP	€ 3.639,00
KCIT105	Copertura invernale completa/Complete winter covering	€ 960,00
KCIT113	Copertura invernale completa con scala romana R 1,5/Complete winter covering roman ladder R1.5	€ 1230,00
KCIT121	Copertura invernale completa con scala rett 1,6x2,4/Complete winter covering rett ladder 1.6x2.4	€ 1166,00
200300014	Lampada LED multicolor/Multi coloured LED lamp	€ 367,65
200300013	Lampada LED bianca/White LED lamp	€ 220,00



## APPROFONDIMENTI/ DETAILS

<http://aqua.quickris.com/pool-kit-mt-6-00x12-00-tipo-b/>



## QR code

Fotografa il codice con lo smartphone e vai direttamente all'approfondimento

Scan the code with your smartphone to obtain more detailed information

## PUBBLICA TIPO B

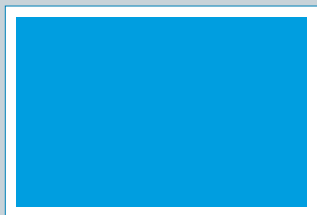

## POOL KIT mt 7.00x14.00 - Tipo B

piscine condominiali, destinate all'uso esclusivo degli abitanti del condominio e dei loro ospiti, esclusi i condomini fino a 4 unità abitative



## POOL KIT 7.00x14.00 m - Type B

condominium pools, exclusively used by the inhabitants of a block of flats and their guests, excluding blocks of flats up to 4 apartments

Codice Code	Altezza pannelli altezza acqua Panel height - Water height	Perimetro Perimeter	Area Surface	Volume Volume	Rivestimento in rotoli h 1.65 Azzurro Pool lining - rolls h 1.65, Light Blue	Filtrazione mc/h v 40 Filtration cu. m/h v 40	Consumo in kw Consumption in kW	Aqua flex tubo rotoli mt 25 Aqua flex pipe, 25 m rolls	Vasca di compenso m <sup>3</sup> Compensation tank cu. m	Aspirafango Mud suction nozzle	N° bocchette No. of nozzles	N° presa di f. No. of main drains	N° fari led bianchi e blue No. of white and blue LED lights	Listino Price List
KBBZA118	123	42.00	98.00	120.54	6	30	1.1x3	5	10	1	6	2	4	€ 42.180,00
KBBZA119	133	42.00	98.00	130.34	6	30	1.1x3	5	10	1	6	2	4	€ 43.865,00



## OPTIONAL

Codice/Code	Descrizione/Description	Price
107101702	Vasca di compenso prefabbricata completa 10.000lt/Complete pre-fabricated compensation tank 10.000lt	€ 5.730,00
ADSALT2150	Sterilizzatore Aqua Salt 150mc + pH/ Aqua Salt Steriliser 150mc + pH	€ 2.190,00
ADPS201	Pannello dosaggio pH - cl/Dosing panel pH-cl	€ 2.774,94
KCIT107	Copertura invernale completa/Complete winter covering	€ 1185,00
KCIT115	Copertura invernale completa con scala romana R 1,5/Complete winter covering roman ladder R1.5	€ 1510,00
KCIT123	Copertura invernale completa con scala rett 1,6x2,4/Complete winter covering rett ladder 1.6x2.4	€ 1437,00
200300014	Lampada LED multicolor/Multi coloured LED lamp	€ 367,65
200300013	Lampada LED bianca/White LED lamp	€ 220,00



## APPROFONDIMENTI/ DETAILS

<http://aqua.quickris.com/pool-kit-mt-7-00x14-00-tipo-b/>



## QR code

Fotografa il codice con lo smartphone e vai direttamente all'approfondimento

Scan the code with your smartphone to obtain more detailed information



## PUBBLICA TIPO B

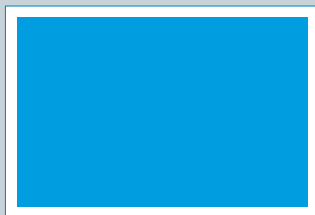

## POOL KIT mt 8.00x16.00 - Tipo B

piscine condominiali, destinate all'uso esclusivo degli abitanti del condominio e dei loro ospiti, esclusi i condomini fino a 4 unità abitative



## POOL KIT 8.00x16.00 m - Type B

condominium pools, exclusively used by the inhabitants of a block of flats and their guests, excluding blocks of flats up to 4 apartments

Codice Code	Altezza pannelli altezza acqua Panel height - Water height	Perimetro Perimeter	Area Surface	Volume Volume	Rivestimento in rotoli h 1.65 Azzurro Pool lining - rolls h 1.65, Light Blue	Filtrazione mc/h v 40 Filtration cu. m/h v 40	Consumo in kw Consumption in kW	Aqua flex tubo rotoli mt.25 Aqua flex pipe, 25 m rolls	Vasca di compenso m <sup>3</sup> Compensation tank cu. m	Aspirafango Mud suction nozzle	N° bocchette No. of nozzles	N° presa di f. No. of main drains	N° fari led bianchi e blue No. of white and blue LED lights	Listino Price List
KBBZA120	123	48.00	128.00	154.44	6½	50.2x2	1.1x3	6	15	2	8	2	6	€ 48.985,00
KBBZA121	133	48.00	128.00	170.24	6½	50.2x2	1.1x3	6	15	2	8	2	6	€ 50.950,00



## OPTIONAL

Codice/Code	Descrizione/Description	Price
107101702	Vasca di compenso prefabbricata completa 10.000lt/Complete pre-fabricated compension tank 10.000lt	€ 5.730,00
ADSALT2200	Sterilizzatore Aqua Salt 200mc + pH/ Aqua Salt Steriliser 200mc + pH	€ 2.500,00
ADPS201	Pannello dosaggio pH - cl/Dosing panel pH-cl	€ 2.774,94
200300014	Lampada LED multicolor/Multi coloured LED lamp	€ 367,65
200300013	Lampada LED bianca/White LED lamp	€ 220,00



## APPROFONDIMENTI/ DETAILS

<http://aqua.quickkris.com/pool-kit-mt-8-00x16-00-tipo-b/>



## QR code

Fotografa il codice con lo smartphone e vai direttamente all'approfondimento

Scan the code with your smartphone to obtain more detailed information

## PUBBLICA TIPO B

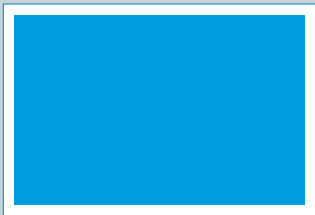

## POOL KIT mt 10.00x20.00 - Tipo B

piscine condominiali, destinate all'uso esclusivo degli abitanti del condominio e dei loro ospiti, esclusi i condomini fino a 4 unità abitative



## POOL KIT 10.00x20.00 m - Type B

condominium pools, exclusively used by the inhabitants of a block of flats and their guests, excluding blocks of flats up to 4 apartments

Codice Code	Altezza pannelli altezza acqua Panel height - Water height	Perimetro Perimeter	Area Surface	Volume Volume	Rivestimento in rotoli h 165 Azzurro Pool lining - rolls h 165, Light Blue	Filtrazione mc/h v 40 Filtration cu. m/h v 40	Consumo in kw Consumption in kW	Aqua flex tubo rotoli mt.25 Aqua flex pipe, 25 m rolls	Vasca di compenso m <sup>3</sup> Compensation tank cu. m	Aspirafango Mud suction nozzle	N° bocchette No. of nozzles	N° presa di f. No. of main drains	N° fari led bianchi e blue No. of white and blue LED lights	Listino Price List
KBBZA122	123	60.00	200.00	246.00	9	77.2x2	2.2x3	6	20	1	10	2	8	€ 86.290,00
KBBZA123	133	60.00	200.00	266.00	9	77.2x2	2.2x3	6	20	1	10	2	8	€ 88.700,00



## OPTIONAL

Codice/Code	Descrizione/Description	Price
107101702	Vasca di compenso prefabbricata completa 10.000lt/Complete pre-fabricated compension tank 10.000lt	€ 5.730,00
ADPS201	Pannello dosaggio pH - cl/Dosing panel pH-cl	€ 2.774,94
200300014	Lampada LED multicolor/Multi coloured LED lamp	€ 367,65
200300013	Lampada LED bianca/White LED lamp	€ 220,00



## APPROFONDIMENTI/ DETAILS

<http://aqua.quickris.com/pool-kit-mt-10-00x20-00-tipo-b/>



## QR code

Fotografa il codice con lo smartphone e vai direttamente all'approfondimento

Scan the code with your smartphone to obtain more detailed information

## PUBBLICA TIPO B



## POOL KIT mt 4.00x8.00 Orione - Tipo B

piscine condominiali, destinate all'uso esclusivo degli abitanti del condominio e dei loro ospiti, esclusi i condomini fino a 4 unità abitative



## POOL KIT 4.00X8.00 m Orione - Type B

condominium pools, exclusively used by the inhabitants of a block of flats and their guests, excluding blocks of flats up to 4 apartments

Codice Code	Altezza pannelli altezza acqua Panel height - Water height	Perimetro Perimeter	Area Surface	Volume Volume	Rivestimento in rotoli h 1,65 Azzurro Pool lining - rolls h 1,65, Light Blue	Filtrazione mc/h v 40 Filtration cu. m/h v 40	Consumo in kw Consumption in kW	Aqua flex tubo rotoli mt 25 Aqua flex pipe, 25 m rolls	Vasca di compenso m <sup>3</sup> Compensation tank cu. m	Aspirafango Mud suction nozzle	N° bocchette No. of nozzles	N° presa di f. No. of main drains	N° fari led bianchi e blue No. of white and blue LED lights	Listino Price List
KBBZA124	123	22.28	30.28	37.25	2½	10	0.75x2	3	3.5	1	2	2	2	€ 20.930,00
KBBZA125	133	22.28	30.28	40.28	2½	17	1.1x2	3	3.5	1	2	2	2	€ 22.595,00



## OPTIONAL

Codice/Code	Descrizione/Description	Price
107101700	Vasca di compenso prefabbricata completa 3.600lt/Complete pre-fabricated compensation tank 3.600lt	€ 2.370,00
ADSALT2050	Sterilizzatore Aqua Salt 50mc + pH/ Aqua Salt Steriliser 50mc + pH	€ 1.700,00
ADPS200	Pannello dosaggio pH - cl/Dosing panel pH-cl	€ 2.726,20
700800304	Pompa di calore 1,5HP/Heat pump 1.5HP	€ 2.256,00
KCIT124	Copertura invernale completa/Complete winter covering	€ 706,00
200300014	Lampada LED multicolor/Multi coloured LED lamp	€ 367,65
200300013	Lampada LED bianca/White LED lamp	€ 220,00



## APPROFONDIMENTI/ DETAILS

<http://aqua.quickris.com/pool-kit-mt-4-00x8-00-orione-tipo-b/>



## QR code

Fotografa il codice con lo smartphone e vai direttamente all'approfondimento

Scan the code with your smartphone to obtain more detailed information



## PUBBLICA TIPO B



## POOL KIT mt 5.00x10.00 Orione - Tipo B

piscine condominiali, destinate all'uso esclusivo degli abitanti del condominio e dei loro ospiti, esclusi i condomini fino a 4 unità abitative



## POOL KIT 5.00x10.00 m Orione - Type B

condominium pools, exclusively used by the inhabitants of a block of flats and their guests, excluding blocks of flats up to 4 apartments

Codice Code	Altezza pannelli altezza acqua Panel height - Water height	Perimetro Perimeter	Area Surface	Volume Volume	Rivestimento in rotoli h 165 Azzurro Pool lining - rolls h 165, Light Blue	Filtrazione mc/h v 40 Filtration cu. m/h v 40	Consumo in kw Consumption in kW	Aqua flex tubo rotoli mt 25 Aqua flex pipe, 25 m rolls	Vasca di compenso m <sup>3</sup> Compensation tank cu. m	Aspirafango Mud suction nozzle	N° bocchette No. of nozzles	N° presa di f. No. of main drains	N° fari led bianchi e blue No. of white and blue LED lights	Listino Price List
KBBZA126	123	27.85	47.32	58.21	3 ½	17	1.1x2	4	5	1	3	2	2	€ 25.975,00
KBBZA127	133	27.85	47.32	62.94	3 ½	17	1.1x2	4	5	1	3	2	2	€ 27.215,00



## OPTIONAL

Codice/Code	Descrizione/Description	Price
107101701	Vasca di compenso prefabbricata completa 5.000lt/Complete pre-fabricated compensation tank 5.000lt	€ 2.460,00
ADSALT2100	Sterilizzatore Aqua Salt 100mc + pH/ Aqua Salt Steriliser 100mc + pH	€ 1.840,00
ADPS200	Pannello dosaggio pH - CL/Dosing panel pH-cl	€ 2.726,20
700800305	Pompa di calore 2,0HP/Heat pump 2.0HP	€ 2.816,00
KCIT125	Copertura invernale completa/Complete winter covering	€ 946,00
200300014	Lampada LED multicolor/Multi coloured LED lamp	€ 367,65
200300013	Lampada LED bianca/White LED lamp	€ 220,00



## APPROFONDIMENTI/ DETAILS

<http://aqua.quickris.com/pool-kit-mt-5-00x10-00-orione-tipo-b/>



## QR code

Fotografa il codice con lo smartphone e vai direttamente all'approfondimento

Scan the code with your smartphone to obtain more detailed information

## PUBBLICA TIPO B



## POOL KIT mt 6.00x12.00 Orione - Tipo B

piscine condominiali, destinate all'uso esclusivo degli abitanti del condominio e dei loro ospiti, esclusi i condomini fino a 4 unità abitative



## POOL KIT 6.00X12.00 M Orione - TYPE B

condominium pools, exclusively used by the inhabitants of a block of flats and their guests, excluding blocks of flats up to 4 apartments

Codice Code	Altezza pannelli altezza acqua Panel height - Water height	Perimetro Perimeter	Area Surface	Volume Volume	Rivestimento in rotoli h 1.65 Azzurro Pool lining - rolls h 1.65, Light Blue	Filtrazione mc/h v 40 Filtration cu. m/h v 40	Consumo in kw Consumption in kW	Aqua flex tubo rotoli mt.25 Aqua flex pipe, 25 m rolls	Vasca di compenso m <sup>3</sup> Compensation tank cu. m	Aspirafango Mud suction nozzle	N° bocchette No. of nozzles	N° presa di f. No. of main drains	N° fari led bianchi e blue No. of white and blue LED lights	Listino Price List
KBBZA128	123	33.42	68.14	88.82	4½	25	1.5x2	4	5	1	4	2	3	€ 30.200,00
KBBZA129	133	33.42	68.14	90.63	4½	25	1.5x2	4	5	1	4	2	3	€ 31.325,00



## OPTIONAL

Codice/Code	Descrizione/Description	Price
107101702	Vasca di compenso prefabbricata completa 10.000lt/Complete pre-fabricated compensation tank 10.000lt	€ 5.730,00
ADSALT2100	Sterilizzatore Aqua Salt 100mc + pH/ Aqua Salt Steriliser 100mc + pH	€ 1.840,00
ADPS200	Pannello dosaggio pH - cl/Dosing panel pH-cl	€ 2.726,20
700800305	Pompa di calore 2,OHP/Heat pump 2.OHP	€ 2.816,00
KCIT126	Copertura invernale completa/Complete winter covering	€ 1.222,00
200300014	Lampada LED multicolor/Multi coloured LED lamp	€ 367,65
200300013	Lampada LED bianca/White LED lamp	€ 220,00



## APPROFONDIMENTI/ DETAILS

<http://aqua.quickris.com/pool-kit-mt-6-00x12-00-orione-tipo-b/>



## QR code

Fotografa il codice con lo smartphone e vai direttamente all'approfondimento

Scan the code with your smartphone to obtain more detailed information

## PUBBLICA TIPO B

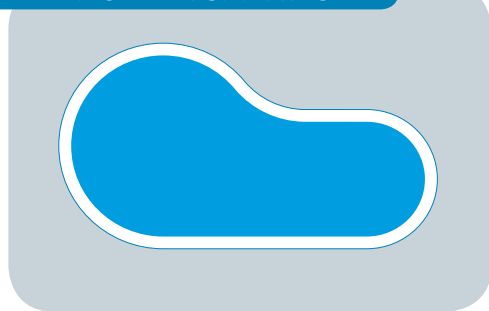

## POOL KIT mt 4.00x8.00 Sirio - Tipo B

piscine condominiali, destinate all'uso esclusivo degli abitanti del condominio e dei loro ospiti, esclusi i condomini fino a 4 unità abitative



## POOL KIT 4.00x8.00 m Sirio - Type B

condominium pools, exclusively used by the inhabitants of a block of flats and their guests, excluding blocks of flats up to 4 apartments

Codice Code	Altezza pannelli altezza acqua Panel height - Water height	Perimetro Perimeter	Area Surface	Volume Volume	Rivestimento in rotoli h 165 Azzurro Pool lining - rolls h 165, Light Blue	Filtrazione mc/h v 40 Filtration cu. m/h v 40	Consumo in kw Consumption in kW	Aqua flex tubo rotoli mt.25 Aqua flex pipe, 25 m rolls	Vasca di compenso m <sup>3</sup> Compensation tank cu. m	Aspirafango Mud suction nozzle	N° bocchette No. of nozzles	N° presa di f. No. of main drains	N° fari led bianchi e blue No. of white and blue LED lights	Listino Price List
KBBZA130	123	20.24	24.64	30.31	2 ½	10	0.75x2	3	3.5	1	2	2	1	€ 20.590,00
KBBZA131	133	20.24	24.64	32.78	2 ½	10	0.75x2	3	3.5	1	2	2	1	€ 21.075,00

**OPTIONAL**

Codice/Code	Descrizione/Description	Price
107101700	Vasca di compenso prefabbricata completa 3.600lt/Complete pre-fabricated compensation tank 3.600lt	€ 2.370,00
ADSALT2050	Sterilizzatore Aqua Salt 50mc + pH/ Aqua Salt Steriliser 50mc + pH	€ 1.700,00
ADPS200	Pannello dosaggio pH - cl/Dosing panel pH-cl	€ 2.726,20
700800304	Pompa di calore 1,5HP/Heat pump 1.5HP	€ 2.256,00
KCIT127	Copertura invernale completa/Complete winter covering	€ 688,00
200300014	Lampada LED multicolor/Multi coloured LED lamp	€ 367,65
200300013	Lampada LED bianca/White LED lamp	€ 220,00



## APPROFONDIMENTI/ DETAILS

<http://aqua.quickris.com/pool-kit-mt-4-00x8-00-sirio-tipo-b/>



## QR code

Fotografa il codice con lo smartphone e vai direttamente all'approfondimento

Scan the code with your smartphone to obtain more detailed information



## PUBBLICA TIPO B

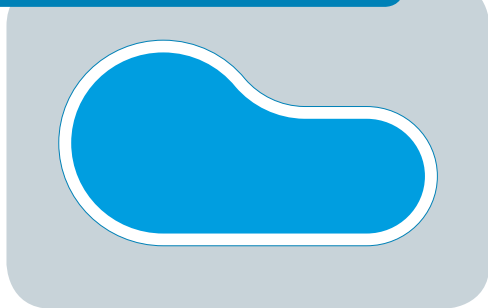

## POOL KIT mt 5.00x10.00 Sirio - Tipo B

piscine condominiali, destinate all'uso esclusivo degli abitanti del condominio e dei loro ospiti, esclusi i condomini fino a 4 unità abitative



## POOL KIT 5.00X10.00 m Sirio - Type B

condominium pools, exclusively used by the inhabitants of a block of flats and their guests, excluding blocks of flats up to 4 apartments

Codice Code	Altezza pannelli altezza acqua Panel height - Water height	Perimetro Perimeter	Area Surface	Volume Volume	Rivestimento in rotoli h 165 Azzurro Pool lining - rolls h 165, Light Blue	Filtrazione mc/h v 40 Filtration cu. m/h v 40	Consumo in kw Consumption in kW	Aqua flex tubo rotoli mt.25 Aqua flex pipe, 25 m rolls	Vasca di compenso m <sup>3</sup> Compensation tank cu. m	Aspirafango Mud suction nozzle	N° bocchette No. of nozzles	N° presa di f. No. of main drains	N° fari led bianchi e blue No. of white and blue LED lights	Listino Price List
KBBZA132	123	25.37	39.56	48.66	3	17	1.1x2	4	5	1	3	2	2	€ 25.205,00
KBBZA133	133	25.37	39.56	52.62	3	17	1.1x2	4	5	1	3	2	2	€ 25.825,00



## OPTIONAL

Codice/Code	Descrizione/Description	Price
107101701	Vasca di compenso prefabbricata completa 5.000lt/Complete pre-fabricated compensation tank 5.000lt	€ 2.460,00
ADSALT2100	Sterilizzatore Aqua Salt 100mc + pH/ Aqua Salt Steriliser 100mc + pH	€ 1.840,00
ADPS200	Pannello dosaggio pH - cl/Dosing panel pH-cl	€ 2.726,20
700800305	Pompa di calore 2,0HP/Heat pump 2.0HP	€ 2.816,00
KCIT128	Copertura invernale completa/Complete winter covering	€ 920,00
200300014	Lampada LED multicolor/Multi coloured LED lamp	€ 367,65
200300013	Lampada LED bianca/White LED lamp	€ 220,00



## APPROFONDIMENTI/ DETAILS

<http://aqua.quickris.com/pool-kit-mt-5-00x10-00-sirio-tipo-b/>



## QR code

Fotografa il codice con lo smartphone e vai direttamente all'approfondimento

Scan the code with your smartphone to obtain more detailed information

## PUBBLICA TIPO B

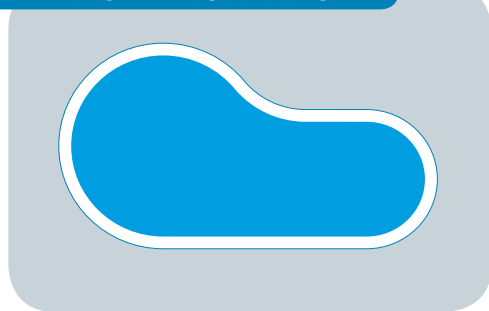

**POOL KIT mt 6.00x12.00 Sirio - Tipo B**  
piscine condominiali, destinate all'uso esclusivo degli abitanti del condominio e dei loro ospiti, esclusi i condomini fino a 4 unità abitative



**POOL KIT 6.00x12.00 m Sirio - Type B**  
condominium pools, exclusively used by the inhabitants of a block of flats and their guests, excluding blocks of flats up to 4 apartments

Codice Code	Altezza pannelli altezza acqua Panel height - Water height	Perimetro Perimeter	Area Surface	Volume Volume	Rivestimento in rotoli h 165 Azzurro Pool lining - rolls h 165, Light Blue	Filtrazione mc/h v 40 Filtration cu. m/h v 40	Consumo in kw Consumption in kW	Aqua flex tubo rotoli mt.25 Aqua flex pipe, 25 m rolls	Vasca di compenso m³ Compensation tank cu. m	Aspirafango Mud suction nozzle	N° bocchette No. of nozzles	N° presa di f. No. of main drains	N° fari led bianchi e blue No. of white and blue LED lights	Listino Price List
KBBZA134	123	30.50	58.06	71.42	4	25	1.5x2	4	5	1	4	2	2	€ 29.340,00
KBBZA135	133	30.50	58.06	77.22	4	25	1.5x2	4	5	1	4	2	2	€ 30.075,00

**OPTIONAL**

Codice/Code	Descrizione/Description	Price
107101701	Vasca di compenso prefabbricata completa 5.000lt/Complete pre-fabricated compensation tank 5.000lt	€ 2.460,00
ADSALT2100	Sterilizzatore Aqua Salt 100mc + pH/ Aqua Salt Steriliser 100mc + pH	€ 1.840,00
ADPS200	Pannello dosaggio pH - cl/Dosing panel pH-cl	€ 2.726,20
700800305	Pompa di calore 2,0HP/Heat pump 2.0HP	€ 2.816,00
KCIT129	Copertura invernale completa/Complete winter covering	€ 1.192,00
200300014	Lampada LED multicolor/Multi coloured LED lamp	€ 367,65
200300013	Lampada LED bianca/White LED lamp	€ 220,00

**APPROFONDIMENTI/ DETAILS**

<http://aqua.quickris.com/pool-kit-mt-6-00x12-00-sirio-tipo-b/>

**QR code**

Fotografa il codice con lo smartphone e vai direttamente all'approfondimento

Scan the code with your smartphone to obtain more detailed information

## PUBBLICA TIPO B



B

**POOL KIT mt 4.00x 8.00 Andromeda - Tipo B**  
piscine condominiali, destinate all'uso esclusivo degli abitanti del condominio e dei loro ospiti, esclusi i condomini fino a 4 unità abitative



*POOL KIT 4.00X 8.00 m Andromeda - Type B*  
condominium pools, exclusively used by the inhabitants of a block of flats and their guests, excluding blocks of flats up to 4 apartments

Codice Code	Altezza pannelli altezza acqua Panel height - Water height	Perimetro Perimeter	Area Surface	Volume Volume	Rivestimento in rotoli h 1.65 Azzurro Pool lining - rolls h 1.65, Light Blue	Filtrazione mc/h v 40 Filtration cu. m/h v 40	Consumo in kw Consumption in kW	Aqua flex tubo rotoli mt.25 Aqua flex pipe, 25 m rolls	Vasca di compenso m <sup>3</sup> Compensation tank cu. m	Aspirafango Mud suction nozzle	N° bocchette No. of nozzles	N° presa di f. No. of main drains	N° fari led bianchi e blue No. of white and blue LED lights	Listino Price List
KBBZA136	123	21.00	29.45	36.23	2½	10	0.78x2	3	3.5	1	2	2	2	€ 22.295,00
KBBZA137	133	21.00	29.45	39.17	2½	17	1.1x2	3	3.5	1	2	2	2	€ 23.640,00



## OPTIONAL

Codice/Code	Descrizione/Description	Price
107101700	Vasca di compenso prefabbricata completa 3.600lt/Complete pre-fabricated compensation tank 3.600lt	€ 2.370,00
ADSALT2050	Sterilizzatore Aqua Salt 50mc + pH/ Aqua Salt Steriliser 50mc + pH	€ 1.700,00
ADPS200	Pannello dosaggio pH - cl/Dosing panel pH-cl	€ 2.726,20
700800304	Pompa di calore 1,5HP/Heat pump 1.5HP	€ 2.256,00
KCIT130	Copertura invernale completa/Complete winter covering	€ 706,00
200300014	Lampada LED multicolor/Multi coloured LED lamp	€ 367,65
200300013	Lampada LED bianca/White LED lamp	€ 220,00



## APPROFONDIMENTI/ DETAILS

<http://aqua.quickris.com/pool-kit-mt-4-00x-8-00-andromeda-tipo-b/>



## QR code

Fotografa il codice con lo smartphone e vai direttamente all'approfondimento

Scan the code with your smartphone to obtain more detailed information



## PUBBLICA TIPO B



**POOL KIT mt 5.00x 10.00 Andromeda - Tipo B**  
piscine condominiali, destinate all'uso esclusivo degli abitanti del condominio e dei loro ospiti, esclusi i condomini fino a 4 unità abitative



*POOL KIT 5.00x 10.00 m Andromeda - Type B*  
condominium pools, exclusively used by the inhabitants of a block of flats and their guests, excluding blocks of flats up to 4 apartments

Codice Code	Altezza pannelli altezza acqua Panel height - Water height	Perimetro Perimeter	Area Surface	Volume Volume	Rivestimento in rotoli h 165 Azzurro Pool lining - rolls h 165, Light Blue	Filtrazione mc/h v 40 Filtration cu. m/h v 40	Consumo in kw Consumption in kW	Aqua flex tubo rotoli mt.25 Aqua flex pipe, 25 m rolls	Vasca di compenso m³ Compensation tank cu. m	Aspirafango Mud suction nozzle	N° bocchette No. of nozzles	N° presa di f. No. of main drains	N° fari led bianchi e blue No. of white and blue LED lights	Listino Price List
KBBZA138	123	26.51	46.64	57.37	3 ½	17	1.1x2	4	5	1	3	2	2	€ 26.595,00
KBBZA139	133	26.51	46.64	62.04	3 ½	17	1.1x2	4	5	1	3	2	2	€ 27.130,00

**OPTIONAL**

Codice/Code	Descrizione/Description	Price
107101701	Vasca di compenso prefabbricata completa 5.000lt/Complete pre-fabricated compensation tank 5.000lt	€ 2.460,00
ADSALT2100	Sterilizzatore Aqua Salt 100mc + pH/ Aqua Salt Steriliser 100mc + pH	€ 1.840,00
ADPS200	Pannello dosaggio pH - cl/Dosing panel pH-cl	€ 2.726,20
700800305	Pompa di calore 2,0HP/Heat pump 2.0HP	€ 2.816,00
KCIT131	Copertura invernale completa/Complete winter covering	€ 938,00
200300014	Lampada LED multicolor/Multi coloured LED lamp	€ 367,65
200300013	Lampada LED bianca/White LED lamp	€ 220,00



## APPROFONDIMENTI/ DETAILS

<http://aqua.quickris.com/pool-kit-mt-5-00x-10-00-andromeda-tipo-b/>



## QR code

Fotografa il codice con lo smartphone e vai direttamente all'approfondimento

Scan the code with your smartphone to obtain more detailed information

## PUBBLICA TIPO B



**POOL KIT mt 6.00x 12.00 Andromeda - Tipo B**  
piscine condominiali, destinate all'uso esclusivo degli abitanti del condominio e dei loro ospiti, esclusi i condomini fino a 4 unità abitative



**POOL KIT 6.00X 10.00 m Andromeda - Type B**  
condominium pools, exclusively used by the inhabitants of a block of flats and their guests, excluding blocks of flats up to 4 apartments

Codice Code	Altezza pannelli altezza acqua Panel height - Water height	Perimetro Perimeter	Area Surface	Volume Volume	Rivestimento in rotoli h 1.65 Azzurro Pool lining - rolls h 1.65, Light Blue	Filtrazione mc/h v 40 Filtration cu. m/h v 40	Consumo in kw Consumption in kW	Aqua flex tubo rotoli mt.25 Aqua flex pipe, 25 m rolls	Vasca di compenso m <sup>3</sup> Compensation tank cu. m	Aspirafango Mud suction nozzle	N° bocchette No. of nozzles	N° presa di f. No. of main drains	N° fari led bianchi e blue No. of white and blue LED lights	Listino Price List
KBBZA140	123	31.98	67.68	83.25	4	25	1.5x2	4	5	1	4	2	3	€ 31.495,00
KBBZA141	133	31.98	67.68	90.02	4	25	1.5x2	4	5	1	4	2	3	€ 32.140,00



## OPTIONAL

Codice/Code	Descrizione/Description	Price
107101702	Vasca di compenso prefabbricata completa 10.000lt/Complete pre-fabricated compensation tank 10.000lt	€ 5.730,00
ADSALT2100	Sterilizzatore Aqua Salt 100mc + pH/ Aqua Salt Steriliser 100mc + pH	€ 1.840,00
ADPS200	Pannello dosaggio pH - cl/Dosing panel pH-cl	€ 2.726,20
700800305	Pompa di calore 2,0HP/Heat pump 2.0HP	€ 2.816,00
KCIT132	Copertura invernale completa/Complete winter covering	€ 1.210,00
200300014	Lampada LED multicolor/Multi coloured LED lamp	€ 367,65
200300013	Lampada LED bianca/White LED lamp	€ 220,00



## APPROFONDIMENTI/ DETAILS

<http://aqua.quickris.com/pool-kit-mt-6-00x-12-00-andromeda-tipo-b/>



## QR code

Fotografa il codice con lo smartphone e vai direttamente all'approfondimento

Scan the code with your smartphone to obtain more detailed information

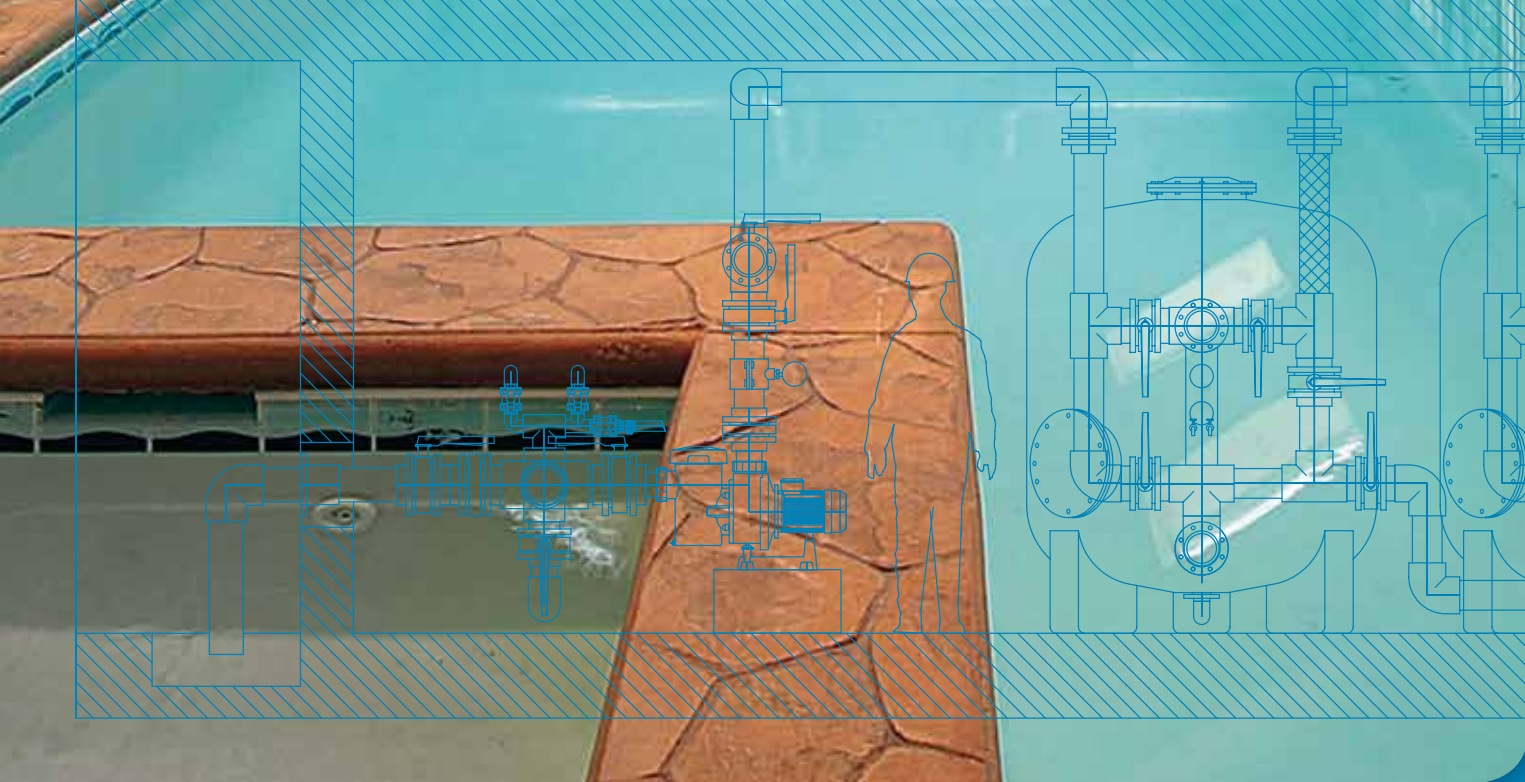
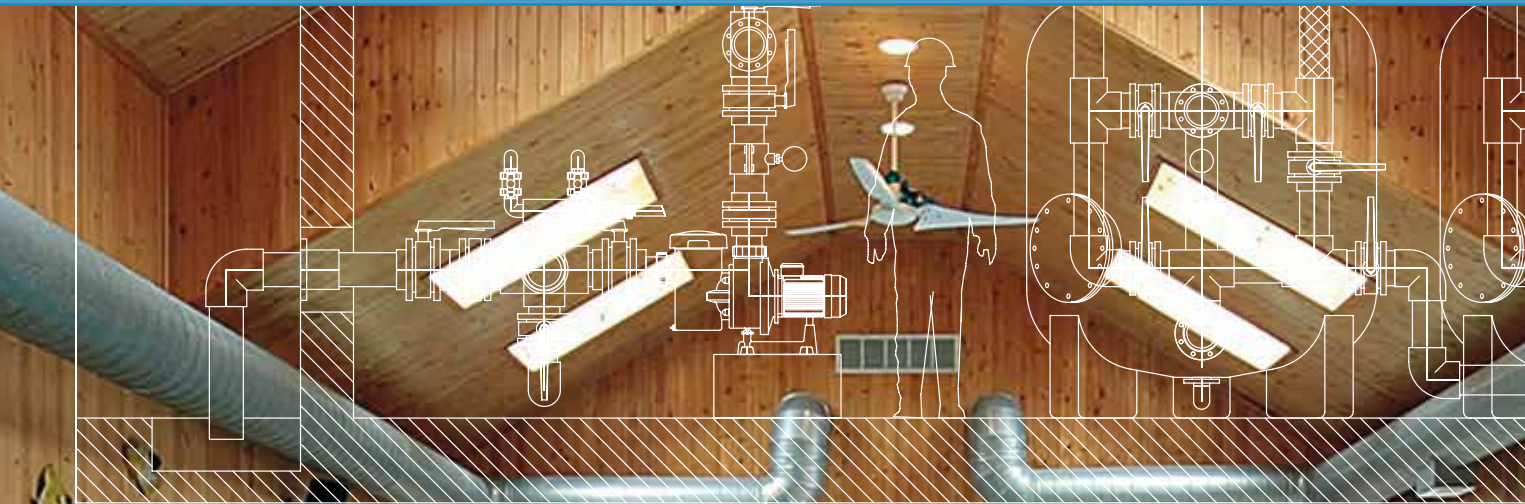



## PRIVATA TIPO D

D



## PRIVATE - TIPO D - BORDO SFIORO

PRIVATE POOLS - TYPE D - OVERFLOW EDGE



## CAMPO DI UTILIZZO

Piscine al servizio di edifici abitativi mono-, bi-, tri-, e quadrifamiliari



## CONTEXT OF USE

Swimming pool for residential building mono - bi - tri or four families.



## CARATTERISTICHE TECNICHE

## 1) STRUTTURA

Tecnologia a Bordo Sfiatore H 120cm +3(bsf) 130cm +3(bsf)  
(vedi tab. pag 135)

## 2) RIVESTIMENTO

PVC armato

## 3) CIRCOLAZIONE

L'immissione in vasca può avvenire dalle pareti o dal fondo, purché si garantisca l'omogeneizzazione.

I sistemi di ripresa immersi e le prese di fondo devono essere sempre collegate in coppia ad una distanza minima di 2 mt.

## 4) FILTRAZIONE

- Velocità di filtrazione  $\delta 50\text{mc/h}$
- Pressione di collaudo deve essere  $\epsilon 1,5$  volte superiore alla pressione massima di esercizio.
- Pressione massima di esercizio con un minimo di 350Kpa.
- Deve essere previsto un numero di filtri  $\geq 1$ ; tutti i filtri devono avere medesime caratteristiche

## 5) ILLUMINAZIONE

- Led

## 6) QUADRO ELETTRICO

- Monofase



## TECHNICAL FEATURES

## 1) STRUCTURE

Overflow technology H 120cm +3(ovf) 130cm +3(ovf)  
(see tab. page 135)

## 2) COATING

Reinforced PVC

## 3) CIRCULATION

The return of the water in the pool can be from the wall or from the bottom, provided it is ensure homogenization.

The suction of the swimming pool and the main drain must always be connected in pairs at a minimum distance of 2 meters.

## 4) FILTRATION

- Filtration speed  $\delta 50\text{mc/h}$
- Pressure test must be  $\epsilon 1,5$  time higher than the maximum pressure.
- Maximum with a minimum of 350Kpa.
- Must be provided a minimum number of filters  $\geq 1$ ; all the filters must have the same characteristic.

## 5) LIGHTING

- Led

## 6) ELECTRICAL BOARD

- Single-phase





#### NORMATIVE

Normativa NTC 2008 - L. n°1086 del 05.11.1971: "Norme per la disciplina delle opere in conglomerato cementizio armato, normale e precompresso e in struttura metallica";  
Ordinanza n°3274 del 20.03.2003: "Primi elementi in materia di criteri generali per la classificazione sismica del territorio nazionale e di normative tecniche per la costruzione in zona sismica";  
D.M. del 14.01.2008: "Norme Tecniche per le costruzioni NTC 2008";  
Circolare ministeriale n°617 del 27.02.2009: "Istruzioni per l'applicazione delle Norme Tecniche per le Costruzioni";  
EC3: EUROCODICE 3 EN 1993 1-3; 1-5; 1-2.  
Carichi e movimentazione D. Lgs. 81/08 (ex 626). (MAX KG.30)  
UNI EN 10637:2006  
UNI EN 13451-1:2002 e 13451-3:2002  
UNI EN 13451-1:2002 e 13451-1:2002



#### STANDARDS

NTC 2008 Standard - Italian Law no. 1086 of 05.11.1971: "Regulations for works in reinforced concrete, pre-stressed reinforced concrete and metal structures";  
Italian Order no.3274 of 20.03.2003: "Basic notions on general seismic classification criteria for the national territory and technical rules for construction in seismic areas";  
Italian Ministerial Decree of 14.01.2008: "Technical Standards for Construction NTC 2008";  
Italian Ministerial Circular no. 617 of 27.02.2009: "Instructions for the application of Technical Standards for Construction";  
EC3: EUROCODE 3 EN 1993 1-3; 1-5; 1-2.  
Loads and handling - Italian Legislative Decree 81/08 (ex 626). (MAX KG.30)  
UNI EN 10637:2006 - UNI EN 13451-1:2002 and 13451-3:2002  
UNI EN 13451-1:2002 and 13451-1:2002



## PRIVATA TIPO D

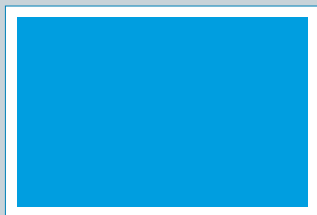

## POOL KIT mt 4.00x8.00 - Tipo D

piscine al servizio di unità abitative monofamiliare, bifamiliari, trifamiliari e quadrifamiliari



POOL KIT 4.00x8.00 m - Type D  
pools for buildings (houses, blocks of flats)  
with up to four apartments

Codice Code	Altezza pannelli altezza acqua Panel height - Water height	Scala recessa Roman steps	Perimetro Perimeter	Area Surface	Volume Volume	Rivestimento in rotoli h 1.65 Azzurro Pool lining - rolls h 1.65, Light Blue	Rivestimento mq. Azzurro antiscivolo Pool lining sq. m Light Blue, non-slip	Filtrazione mc/h v 50 Filtration cu. m/h v 50	Consumo in kw Consumption in kW	Aqua flex tubo rotoli mt 25 Aqua flex pipe, 25 m rolls	Vasca di compenso m <sup>3</sup> Compensation tank cu. m	Aspirafango Mud suction nozzle	N° bocchette No. of nozzles	N° presa di f. No. of main drains	N° fari led bianchi e blue No. of white and blue LED lights	Listino Price List
KDBZA100	123		24.00	32.00	39.36	2½		10	0.50	3	3.5	1	2	1	2	€ 19.470,00
KDBZA101	123	R 1.5	26.46	36.66	45.10	3	8.25	10	0.50	3	3.5	1	2	1	2	€ 22.135,00
KDBZA102	123	1.6x2.4	27.20	35.84	44.09	3	8.25	10	0.50	3	3.5	1	2	1	2	€ 21.955,00
KDBZA103	133		24.00	32.00	42.56	2½		10	0.50	3	3.5	1	2	1	2	€ 20.340,00
KDBZA104	133	R 1.5	26.46	36.66	48.76	3	8.25	10	0.50	3	3.5	1	2	1	2	€ 23.130,00
KDBZA105	133	1.6x2.4	27.20	35.84	47.67	3	8.25	10	0.50	3	3.5	1	2	1	2	€ 23.060,00

\* Per altezze 120-130 possibilità di tramoggia / For heights 120-130 possibility of hopper



## OPTIONAL

Codice/Code	Descrizione/Description	Price
107101700	Vasca di compenso prefabbricata completa 3.600lt/Complete pre-fabricated compensation tank 3.600lt	€ 2.460,00
ADSALT2050	Sterilizzatore Aqua Salt 50mc + pH/ Aqua Salt Steriliser 50mc + pH	€ 1.700,00
ADPS100	Pannello dosaggio pH - Rx/Dosing panel pH - Rx	€ 1.446,12
700800304	Pompa di calore 1,5HP/Heat pump 1.5HP	€ 2.256,00
KCIT101	Copertura invernale completa/Complete winter covering	€ 580,00
KCIT109	Copertura invernale completa con scala romana R 1,5/Complete winter covering roman ladder R1.5	€ 753,00
KCIT117	Copertura invernale completa con scala rett 1,6x2,4/Complete winter covering rett ladder 1.6x2.4	€ 720,00
200300014	Lampada LED multicolor/Multi coloured LED lamp	€ 367,65
200300013	Lampada LED bianca/White LED lamp	€ 220,00



## APPROFONDIMENTI/ DETAILS

<http://aqua.quickris.com/pool-kit-mt-4-00x8-00-tipo-d/>



## QR code

Fotografa il codice con lo smartphone e vai direttamente all'approfondimento

Scan the code with your smartphone to obtain more detailed information

## PRIVATA TIPO D

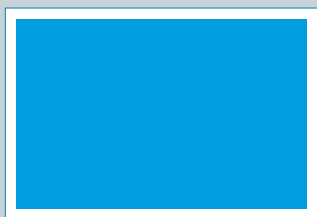

## POOL KIT mt 5.00x10.00 - Tipo D

piscine al servizio di unità abitative monofamiliare, bifamiliari, trifamiliari e quadrifamiliari



## POOL KIT 5.00x10.00 m - Type D

pools for buildings (houses, blocks of flats) with up to four apartments

Codice Code	Altezza pannelli altezza acqua Panel height - Water height	Scala recessa Roman steps	Perimetro Perimeter	Area Surface	Volume Volume	Rivestimento in rotoli h 1,65 Azzurro Pool lining - rolls h 1,65, Light Blue	Rivestimento mq. Azzurro antiscivolo Pool lining sq. m Light Blue, non-slip	Filtrazione mc/h v 50 Filtration cu. m/h v 50	Consumo in kw Consumption in kW	Acqua flex tubo rotoli mt 25 Aqua flex pipe, 25 m rolls	Vasca di compenso m <sup>3</sup> Compensation tank cu. m	Aspirafango Mud suction nozzle	N° bocchette No. of nozzles	N° presa di f. No. of main drains	N° fari led bianchi e blue No. of white and blue LED lights	Listino Price List
KDBZA106	123		30.00	50.00	61.50	3½		14	0.75	3	3.5	1	3	1	2	€ 24.470,00
KDBZA107	123	R 1.5	32.46	54.66	67.24	4	8.25	14	0.75	3	3.5	1	3	1	2	€ 27.425,00
KDBZA108	123	1.6x2.4	33.20	53.84	66.23	4	8.25	14	0.75	3	3.5	1	3	1	2	€ 27.035,00
KDBZA109	133		30.00	50.00	66.50	3½		14	0.75	3	3.5	1	3	1	2	€ 25.105,00
KDBZA110	133	R 1.5	32.46	54.66	72.70	4	8.25	14	0.75	3	3.5	1	3	1	2	€ 28.090,00
KDBZA111	133	1.6x2.4	33.20	53.84	71.61	4	8.25	14	0.75	3	3.5	1	3	1	2	€ 27.810,00

\* Per altezze 120-130 possibilità di tramoggia / For heights 120-130 possibility of hopper

**OPTIONAL**

Codice/Code	Descrizione/Description	Price
107101701	Vasca di compenso prefabbricata completa 5.000lt/Complete pre-fabricated compensation tank 5.000lt	€ 2.460,00
ADSALT2100	Sterilizzatore Aqua Salt 100mc + pH/ Aqua Salt Steriliser 100mc + pH	€ 1.840,00
ADPS100	Pannello dosaggio pH - Rx/Dosing panel pH - Rx	€ 1.446,12
700800305	Pompa di calore 2,0HP/Heat pump 2.0HP	€ 2.816,00
KCIT103	Copertura invernale completa/Complete winter covering	€ 757,00
KCIT111	Copertura invernale completa con scala romana R 1,5/Complete winter covering roman ladder R1.5	€ 980,00
KCIT119	Copertura invernale completa con scala rett 1,6x2,4/Complete winter covering rett ladder 1.6x2.4	€ 930,00
200300014	Lampada LED multicolor/Multi coloured LED lamp	€ 367,65
200300013	Lampada LED bianca/White LED lamp	€ 220,00



## APPROFONDIMENTI/ DETAILS

<http://aqua.quickris.com/pool-kit-mt-5-00x10-00-tipo-d/>



## QR code

Fotografa il codice con lo smartphone e vai direttamente all'approfondimento

Scan the code with your smartphone to obtain more detailed information



## PRIVATA TIPO D

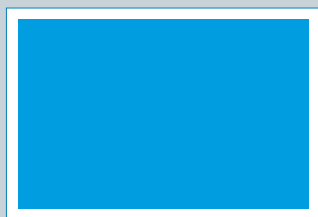

## POOL KIT mt 6.00x12.00 - Tipo D

piscine al servizio di unità abitative monofamiliare, bifamiliari, trifamiliari e quadrifamiliari



## POOL KIT 6.00x12.00 m - Type D

pools for buildings (houses, blocks of flats) with up to four apartments

Codice Code	Altezza pannelli altezza acqua Panel height - Water height	Scala recessa Roman steps	Perimetro Perimeter	Area Surface	Volume Volume	Rivestimento in rotoli h 165 Azzurro Pool lining - rolls h 165, Light Blue	Rivestimento mq. Azzurro antiscivolo Pool lining sq. m Light Blue, non-slip	Filtrazione mc/h v 50 Filtration cu. m/h v 50	Consumo in kw Consumption in kW	Aqua flex tubo rotoli mt 25 Aqua flex pipe, 25 m rolls	Vasca di compenso m <sup>3</sup> Compensation tank cu. m	Aspirafango Mud suction nozzle	N° bocchette No. of nozzles	N° presa di f. No. of main drains	N° fari led bianchi e blue No. of white and blue LED lights	Listino Price List
KDBZA112	123		36.00	72.00	88.56	5½		22	1.5	4	5	1	4	1	3	€ 28.120,00
KDBZA113	123	R 1.5	38.46	76.66	94.30	6	8.25	22	1.5	4	5	1	4	1	3	€ 31.895,00
KDBZA114	123	1.6x2.4	37.20	75.84	93.29	6	8.25	22	1.5	4	5	1	4	1	3	€ 31.515,00
KDBZA115	133		36.00	72.00	95.76	5½		22	1.5	4	5	1	4	1	3	€ 29.455,00
KDBZA116	133	R 1.5	38.46	76.66	101.96	6	8.25	22	1.5	4	5	1	4	1	3	€ 33.360,00
KDBZA117	133	1.6x2.4	37.20	75.84	100.87	6	8.25	22	1.5	4	5	1	4	1	3	€ 33.260,00

\* Per altezze 120-130 possibilità di tramoggia / For heights 120-130 possibility of hopper



## OPTIONAL

Codice/Code	Descrizione/Description	Price
107101702	Vasca di compenso prefabbricata completa 10.000 lt/Complete pre-fabricated compensation tank 10.000 lt	€ 5.730,00
ADSALT2100	Sterilizzatore Aqua Salt 100mc + pH/ Aqua Salt Steriliser 100mc + pH	€ 1.840,00
ADPS100	Pannello dosaggio pH - Rx/Dosing panel pH - Rx	€ 1.446,12
700800306	Pompa di calore 2,5HP/Heat pump 2.5HP	€ 3.639,00
KCIT105	Copertura invernale completa/Complete winter covering	€ 960,00
KCIT113	Copertura invernale completa con scala romana R 1,5/Complete winter covering roman ladder R1.5	€ 1.230,00
KCIT121	Copertura invernale completa con scala rett 1,6x2,4/Complete winter covering rett ladder 1.6x2.4	€ 1.166,00
200300014	Lampada LED multicolor/Multi coloured LED lamp	€ 367,65
200300013	Lampada LED bianca/White LED lamp	€ 220,00



## APPROFONDIMENTI/ DETAILS

<http://aqua.quickris.com/pool-kit-mt-6-00x12-00-tipo-d/>



## QR code

Fotografa il codice con lo smartphone e vai direttamente all'approfondimento

Scan the code with your smartphone to obtain more detailed information



## PRIVATA TIPO D

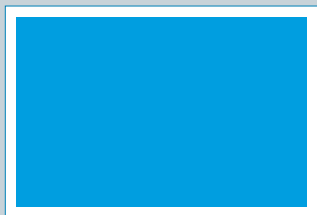

## POOL KIT mt 7.00x14.00 - Tipo D

piscine al servizio di unità abitative monofamiliare, bifamiliari, trifamiliari e quadrifamiliari



## POOL KIT 7.00x14.00 m - Type D

pools for buildings (houses, blocks of flats) with up to four apartments

Codice Code	Altezza pannelli altezza acqua Panel height - Water height	Perimetro Perimeter	Area Surface	Volume Volume	Rivestimento in rotoli h 165 Azzurro Pool lining - rolls h 165, Light Blue	Filtrazione mc/h v 50 Filtration cu. m/h v 50	Consumo in kw Consumption in kW	Aqua flex tubo rotoli mt 25 Aqua flex pipe, 25 m rolls	Vasca di compenso m <sup>3</sup> Compensation tank cu. m	Aspirafango Mud suction nozzle	N° bocchette No. of nozzles	N° presa di f. No. of main drains	N° fari led bianchi e blue No. of white and blue LED lights	Listino Price List
KDBZA118	123	42.00	146.50	120.54	6	30	2.2	5	5	1	5	1	4	€ 35.765,00
KDBZA119	133	42.00	134.20	130.34	6	30	2.2	5	5	1	5	1	4	€ 37.450,00

\* Per altezze 120-130 possibilità di tramoggia / For heights 120-130 possibility of hopper

 OPTIONAL

Codice/Code	Descrizione/Description	Price
107101702	Vasca di compenso prefabbricata completa 10.000 lt/Complete pre-fabricated compensation tank 10.000 lt	€ 5.730,00
ADSALT2150	Sterilizzatore Aqua Salt 150mc + pH/ Aqua Salt Steriliser 150mc + pH	€ 2.190,00
ADPS101	Pannello dosaggio pH - Rx/Dosing panel pH - Rx	€ 1.494,86
KCIT107	Copertura invernale completa/Complete winter covering	€ 1.185,00
KCIT115	Copertura invernale completa con scala romana R 1,5/Complete winter covering roman ladder R1.5	€ 1.510,00
KCIT123	Copertura invernale completa con scala rett 1,6x2,4/Complete winter covering rett ladder 1.6x2.4	€ 1.437,00
200300014	Lampada LED multicolor/Multi coloured LED lamp	€ 367,65
200300003	Lampada LED bianca/White LED lamp	€ 220,00



## APPROFONDIMENTI/ DETAILS

<http://aqua.quickris.com/pool-kit-mt-7-00x14-00-tipo-d/>



## QR code

Fotografa il codice con lo smartphone e vai direttamente all'approfondimento

Scan the code with your smartphone to obtain more detailed information

## PRIVATA TIPO D



**POOL KIT mt 4.00x8.00 Orione - Tipo D**  
piscine al servizio di unità abitative monofamiliare, bifamiliari,  
trifamiliari e quadrifamiliari



*POOL KIT 4.00x8.00 m Orione - Type D*  
*pools for buildings (houses, blocks of flats)*  
*with up to four apartments*

Codice Code	Altezza pannelli altezza acqua Panel height - Water height	Perimetro Perimeter	Area Surface	Volume Volume	Rivestimento in rotoli h 165 Azzurro Pool lining - rolls h 165, Light Blue	Filtrazione mc/h v 50 Filtration cu. m/h v 50	Consumo in kw Consumption in kW	Aqua flex tubo rotoli mt 25 Aqua flex pipe, 25 m rolls	Vasca di compenso m <sup>3</sup> Compensation tank cu. m	Aspirafango Mud suction nozzle	N° bocchette No. of nozzles	N° presa di f. No. of main drains	N° fari led bianchi e blue No. of white and blue LED lights	Listino Price List
KDBZA120	123	22.28	30.28	37.25	2½	10	0.50	3	3.5	1	2	1	2	€ 19.035,00
KDBZA121	133	22.28	30.28	40.28	2½	10	0.50	3	3.5	1	2	1	2	€ 19.785,00



## OPTIONAL

Codice/Code	Descrizione/Description	Price
107101700	Vasca di compenso prefabbricata completa 3.600 lt/Complete pre-fabricated compensation tank 3.600 lt	€ 2.370,00
ADSALT2050	Sterilizzatore Aqua Salt 50mc + pH/ Aqua Salt Steriliser 50mc + pH	€ 1.700,00
ADPS100	Pannello dosaggio pH - Rx/Dosing panel pH - Rx	€ 1.446,12
700800304	Pompa di calore 1,5HP/Heat pump 1.5HP	€ 2.256,00
KCIT124	Copertura invernale completa/Complete winter covering	€ 706,00
200300014	Lampada LED multicolor/Multi coloured LED lamp	€ 367,65
200300013	Lampada LED bianca/White LED lamp	€ 220,00



## APPROFONDIMENTI/ DETAILS

<http://aqua.quickris.com/pool-kit-mt-4-00x8-00-orione-tipo-d/>



## QR code

Fotografa il codice con lo smartphone e vai direttamente all'approfondimento

Scan the code with your smartphone to obtain more detailed information

## PRIVATA TIPO D



**POOL KIT mt 5.00x10.00 Orione - Tipo D**  
 piscine al servizio di unità abitative monofamiliare, bifamiliari,  
 trifamiliari e quadrifamiliari



*POOL KIT 5.00x10.00 m Orione - Type D*  
 pools for buildings (houses, blocks of flats)  
 with up to four apartments

Codice Code	Altezza pannelli altezza acqua Panel height - Water height	Perimetro Perimeter	Area Surface	Volume Volume	Rivestimento in rotoli h 165 Azzurro Pool lining - rolls h 165, Light Blue	Filtrazione mc/h v 50 Filtration cu. m/h v 50	Consumo in kw Consumption in kW	Aqua flex tubo rotoli mt 25 Aqua flex pipe, 25 m rolls	Vasca di compenso m <sup>3</sup> Compensation tank cu. m	Aspirafango Mud suction nozzle	N° bocchette No. of nozzles	N° presa di f. No. of main drains	N° fari led bianchi e blue No. of white and blue LED lights	Listino Price List
KDBZA122	123	27.85	47.32	58.21	3½	14	0.75	3	3.5	1	3	1	2	€ 23.440,00
KDBZA123	133	27.85	47.32	62.94	3½	14	0.75	3	3.5	1	3	1	2	€ 24.375,00



## OPTIONAL

Codice/Code	Descrizione/Description	Price
107101701	Vasca di compenso prefabbricata completa 5.000 lt/Complete pre-fabricated compensation tank 5.000 lt	€ 2.460,00
ADSALT2100	Sterilizzatore Aqua Salt 100mc + pH/ Aqua Salt Steriliser 100mc + pH	€ 1.840,00
ADPS100	Pannello dosaggio pH - Rx/Dosing panel pH - Rx	€ 1.446,12
700800305	Pompa di calore 2,0HP/Heat pump 2.0HP	€ 2.816,00
KCIT125	Copertura invernale completa/Complete winter covering	€ 946,00
200300014	Lampada LED multicolor/Multi coloured LED lamp	€ 367,65
200300013	Lampada LED bianca/White LED lamp	€ 220,00



## APPROFONDIMENTI/ DETAILS

<http://aqua.quickris.com/pool-kit-mt-5-00x10-00-orione-tipo-d/>



## QR code

Fotografa il codice con lo smartphone e vai direttamente all'approfondimento

Scan the code with your smartphone to obtain more detailed information

## PRIVATA TIPO D



**POOL KIT mt 6.00x12.00 Orione - Tipo D**  
piscine al servizio di unità abitative monofamiliare, bifamiliari,  
trifamiliari e quadrifamiliari

*POOL KIT 6.00x12.00 m Orione - Type D*  
*pools for buildings (houses, blocks of flats)*  
*with up to four apartments*

Codice Code	Altezza pannelli altezza acqua Panel height - Water height	Perimetro Perimeter	Area Surface	Volume Volume	Rivestimento in rotoli h 165 Azzurro Pool lining - rolls h 165, Light Blue	Filtrazione mc/h v 50 Filtration cu. m/h v 50	Consumo in kw Consumption in kW	Aqua flex tubo rotoli mt 25 Aqua flex pipe, 25 m rolls	Vasca di compenso m <sup>3</sup> Compensation tank cu. m	Aspirafango Mud suction nozzle	N° bocchette No. of nozzles	N° presa di f. No. of main drains	N° fari led bianchi e blue No. of white and blue LED lights	Listino Price List
KDBZA124	123	33.42	68.14	88.82	4½	22	1.5	4	5	1	4	1	3	€ 27.880,00
KDBZA125	133	33.42	68.14	90.63	4½	22	1.5	4	5	1	4	1	3	€ 29.005,00



## OPTIONAL

Codice/Code	Descrizione/Description	Price
107101702	Vasca di compenso prefabbricata completa 10.000 lt/Complete pre-fabricated compensation tank 10.000 lt	€ 5.730,00
ADSALT2100	Sterilizzatore Aqua Salt 100mc + pH/ Aqua Salt Steriliser 100mc + pH	€ 1.840,00
ADPS100	Pannello dosaggio pH - Rx/Dosing panel pH - Rx	€ 1.446,12
700800305	Pompa di calore 2,0HP/Heat pump 2,0HP	€ 2.816,00
KCIT126	Copertura invernale completa/Complete winter covering	€ 1.222,00
200300014	Lampada LED multicolor/Multi coloured LED lamp	€ 367,65
200300013	Lampada LED bianca/White LED lamp	€ 220,00



## APPROFONDIMENTI/ DETAILS

<http://aqua.quickris.com/pool-kit-mt-6-00x12-00-orione-tipo-d/>



## QR code

Fotografa il codice con lo smartphone e vai direttamente all'approfondimento

Scan the code with your smartphone to obtain more detailed information



## PRIVATA TIPO D



**POOL KIT mt 4.00x8.00 Sirio - Tipo D**  
piscine al servizio di unità abitative monofamiliare, bifamiliari,  
trifamiliari e quadrifamiliari

*POOL KIT 4.00x8.00 m Sirio - Type D*  
*pools for buildings (houses, blocks of flats)*  
*with up to four apartments*

Codice Code	Altezza pannelli altezza acqua Panel height - Water height	Perimetro Perimeter	Area Surface	Volume Volume	Rivestimento in rotoli h 165 Azzurro Pool lining - rolls h 165, Light Blue	Filtrazione mc/h v 50 Filtration cu. m/h v 50	Consumo in kw Consumption in kW	Aqua flex tubo rotoli mt 25 Aqua flex pipe, 25 m rolls	Vasca di compenso m <sup>3</sup> Compensation tank cu. m	Aspirafango Mud suction nozzle	N° bocchette No. of nozzles	N° presa di f. No. of main drains	N° fari led bianchi e blue No. of white and blue LED lights	Listino Price List
KDBZA126	123	20.24	24.64	30.31	2½	10	0.50	3	3.5	1	2	1	1	€ 18.695,00
KDBZA127	133	20.24	24.64	32.78	2½	10	0.50	3	3.5	1	2	1	1	€ 19.180,00



## OPTIONAL

Codice/Code	Descrizione/Description	Price
107101700	Vasca di compenso prefabbricata completa 3.600 lt/Complete pre-fabricated compensation tank 3.600 lt	€ 2.370,00
ADSALT2050	Sterilizzatore Aqua Salt 50mc + pH/ Aqua Salt Steriliser 50mc + pH	€ 1.700,00
ADPS100	Pannello dosaggio pH - Rx/Dosing panel pH - Rx	€ 1.446,12
700800304	Pompa di calore 1,5HP/Heat pump 1.5HP	€ 2.256,00
KCIT127	Copertura invernale completa/Complete winter covering	€ 688,00
200300014	Lampada LED multicolor/Multi coloured LED lamp	€ 367,65
200300013	Lampada LED bianca/White LED lamp	€ 220,00



## APPROFONDIMENTI/ DETAILS

<http://aqua.quickris.com/pool-kit-mt-4-00x8-00-sirio-tipo-d/>



## QR code

Fotografa il codice con lo smartphone e vai direttamente all'approfondimento

Scan the code with your smartphone to obtain more detailed information

## PRIVATA TIPO D

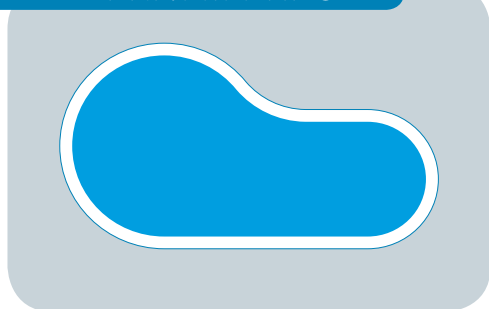

**POOL KIT mt 5.00x10.00 Sirio - Tipo D**  
piscine al servizio di unità abitative monofamiliare, bifamiliari,  
trifamiliari e quadrifamiliari



*POOL KIT 5.00x10.00 m Sirio - Type D*  
*pools for buildings (houses, blocks of flats)*  
*with up to four apartments*

Codice Code	Altezza pannelli altezza acqua Panel height - Water height	Perimetro Perimeter	Area Surface	Volume Volume	Rivestimento in rotoli h 165 Azzurro Pool lining - rolls h 165, Light Blue	Filtrazione mc/h v 50 Filtration cu. m/h v 50	Consumo in kw Consumption in kW	Aqua flex tubo rotoli mt 25 Aqua flex pipe, 25 m rolls	Vasca di compenso m <sup>3</sup> Compensation tank cu. m	Aspirafango Mud suction nozzle	N° bocchette No. of nozzles	N° presa di f. No. of main drains	N° fari led bianchi e blue No. of white and blue LED lights	Listino Price List
KDBZA128	123	25.37	39.56	48.66	3	14	0.75	3	3.5	1	3	1	2	€ 22.580,00
KDBZA129	133	25.37	39.56	52.62	3	14	0.75	3	3.5	1	3	1	2	€ 23.200,00



## OPTIONAL

Codice/Code	Descrizione/Description	Price
107101701	Vasca di compenso prefabbricata completa 5.000 lt/Complete pre-fabricated compensation tank 5.000 lt	€ 2.460,00
ADSALT2100	Sterilizzatore Aqua Salt 100mc + pH/ Aqua Salt Steriliser 100mc + pH	€ 1.840,00
ADPS100	Pannello dosaggio pH - Rx/Dosing panel pH - Rx	€ 1.446,12
700800305	Pompa di calore 2,0HP/Heat pump 2,0HP	€ 2.816,00
KCIT128	Copertura invernale completa/Complete winter covering	€ 920,00
200300014	Lampada LED multicolor/Multi coloured LED lamp	€ 367,65
200300013	Lampada LED bianca/White LED lamp	€ 220,00



## APPROFONDIMENTI/ DETAILS

<http://aqua.quickris.com/pool-kit-mt-5-00x10-00-sirio-tipo-d/>



## QR code

Fotografa il codice con lo smartphone e vai direttamente all'approfondimento

Scan the code with your smartphone to obtain more detailed information

## PRIVATA TIPO D

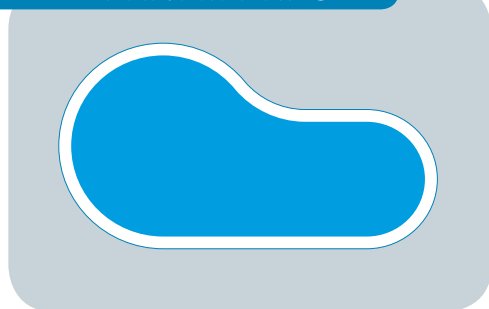

**POOL KIT mt 6.00x12.00 Sirio - Tipo D**  
piscine al servizio di unità abitative monofamiliare, bifamiliari,  
trifamiliari e quadrifamiliari



*POOL KIT 6.00x12.00 m Sirio - Type D*  
*pools for buildings (houses, blocks of flats)*  
*with up to four apartments*

Codice Code	Altezza pannelli altezza acqua Panel height - Water height	Perimetro Perimeter	Area Surface	Volume Volume	Rivestimento in rotoli h 165 Azzurro Pool lining - rolls h 165, Light Blue	Filtrazione mc/h v 50 Filtration cu. m/h v 50	Consumo in kw Consumption in kW	Aqua flex tubo rotoli mt 25 Aqua flex pipe, 25 m rolls	Vasca di compenso m <sup>3</sup> Compensation tank cu. m	Aspirafango Mud suction nozzle	N° bocchette No. of nozzles	N° presa di f. No. of main drains	N° fari led bianchi e blue No. of white and blue LED lights	Listino Price List
KDBZA130	123	30.50	58.06	71.42	4	22	1.5	4	5	1	4	1	3	€ 27.480,00
KDBZA131	133	30.50	58.06	77.22	4	22	1.5	4	5	1	4	1	3	€ 28.215,00



## OPTIONAL

Codice/Code	Descrizione/Description	Price
107101701	Vasca di compenso prefabbricata completa 5.000 lt/Complete pre-fabricated compensation tank 5.000 lt	€ 2.460,00
ADSALT2100	Sterilizzatore Aqua Salt 100mc + pH/ Aqua Salt Steriliser 100mc + pH	€ 1.840,00
ADPS100	Pannello dosaggio pH - Rx/Dosing panel pH - Rx	€ 1.446,12
700800305	Pompa di calore 2,0HP/Heat pump 2.0HP	€ 2.816,00
KCIT129	Copertura invernale completa/Complete winter covering	€ 1.192,00
200300014	Lampada LED multicolor/Multi coloured LED lamp	€ 367,65
200300013	Lampada LED bianca/White LED lamp	€ 220,00



## APPROFONDIMENTI/ DETAILS

<http://aqua.quickris.com/pool-kit-mt-6-00x12-00-sirio-tipo-d/>



## QR code

Fotografa il codice con lo smartphone e vai direttamente all'approfondimento

Scan the code with your smartphone to obtain more detailed information

## PRIVATA TIPO D



**POOL KIT mt 4.00x 8.00 Andromeda - Tipo D**  
piscine al servizio di unità abitative monofamiliare, bifamiliari,  
trifamiliari e quadrifamiliari



*POOL KIT 4.00x 8.00 m Andromeda - Type D*  
*pools for buildings (houses, blocks of flats)*  
*with up to four apartments*

Codice Code	Altezza pannelli altezza acqua Panel height - Water height	Perimetro Perimeter	Area Surface	Volume Volume	Rivestimento in rotoli h 165 Azzurro Pool lining - rolls h 165, Light Blue	Filtrazione mc/h v 50 Filtration cu. m/h v 50	Consumo in kw Consumption in kW	Aqua flex tubo rotoli mt 25 Aqua flex pipe, 25 m rolls	Vasca di compenso m <sup>3</sup> Compensation tank cu. m	Aspirafango Mud suction nozzle	N° bocchette No. of nozzles	N° presa di f. No. of main drains	N° fari led bianchi e blue No. of white and blue LED lights	Listino Price List
KDBZA132	123	21.00	29.45	36.23	2½	10	0.50	3	3.5	1	2	1	2	€ 16.335,00
KDBZA133	133	21.00	29.45	39.17	2½	10	0.50	3	3.5	1	2	1	2	€ 20.775,00



## OPTIONAL

Codice/Code	Descrizione/Description	Price
107101700	Vasca di compenso prefabbricata completa 3.600 lt/Complete pre-fabricated compensation tank 3.600 lt	€ 2.370,00
ADSALT2050	Sterilizzatore Aqua Salt 50mc + pH/ Aqua Salt Steriliser 50mc + pH	€ 1.700,00
ADPS100	Pannello dosaggio pH - Rx/Dosing panel pH - Rx	€ 1.446,12
700800304	Pompa di calore 1,5HP/Heat pump 1.5HP	€ 2.256,00
KCIT130	Copertura invernale completa/Complete winter covering	€ 706,00
200300014	Lampada LED multicolor/Multi coloured LED lamp	€ 367,65
200300013	Lampada LED bianca/White LED lamp	€ 220,00



## APPROFONDIMENTI/ DETAILS

<http://aqua.quickkris.com/pool-kit-mt-4-00x-8-00-andromeda-tipo-d/>



## QR code

Fotografa il codice con lo smartphone e vai direttamente all'approfondimento

Scan the code with your smartphone to obtain more detailed information



## PRIVATA TIPO D



**POOL KIT mt 5.00x10.00 Andromeda - Tipo D**  
piscine al servizio di unità abitative monofamiliare, bifamiliari, trifamiliari e quadrifamiliari



**POOL KIT 4.00x 8.00 m Andromeda - Type D**  
pools for buildings (houses, blocks of flats)  
with up to four apartments

Codice Code	Altezza pannelli altezza acqua Panel height - Water height	Perimetro Perimeter	Area Surface	Volume Volume	Rivestimento in rotoli h 165 Azzurro Pool lining - rolls h 165, Light Blue	Filtrazione mc/h v 50 Filtration cu. m/h v 50	Consumo in kw Consumption in kW	Aqua flex tubo rotoli mt 25 Aqua flex pipe, 25 m rolls	Vasca di compenso m <sup>3</sup> Compensation tank cu. m	Aspirafango Mud suction nozzle	N° bocchette No. of nozzles	N° presa di f. No. of main drains	N° fari led bianchi e blue No. of white and blue LED lights	Listino Price List
KDBZA134	123	26.51	46.64	57.37	3½	14	0.75	3	3.5	1	3	1	2	€ 24.000,00
KDBZA135	133	26.51	46.64	62.04	3½	14	0.75	3	3.5	1	3	1	2	€ 24.530,00

## + OPTIONAL

Codice/Code	Descrizione/Description	Price
107101701	Vasca di compenso prefabbricata completa 5.000 lt/Complete pre-fabricated compensation tank 5.000 lt	€ 2.460,00
ADSALT2100	Sterilizzatore Aqua Salt 100mc + pH/ Aqua Salt Steriliser 100mc + pH	€ 1.840,00
ADPS100	Pannello dosaggio pH - Rx/Dosing panel pH - Rx	€ 1.446,12
700800305	Pompa di calore 2,0HP/Heat pump 2.0HP	€ 2.816,00
KCIT131	Copertura invernale completa/Complete winter covering	€ 938,00
200300014	Lampada LED multicolor/Multi coloured LED lamp	€ 367,65
200300013	Lampada LED bianca/White LED lamp	€ 220,00



### APPROFONDIMENTI/ DETAILS

<http://aqua.quickris.com/pool-kit-mt-5-00x10-00-andromeda-tipo-d/>



### QR code

Fotografa il codice con lo smartphone e vai direttamente all'approfondimento

Scan the code with your smartphone to obtain more detailed information

## PRIVATA TIPO D



**POOL KIT mt 6.00x 12.00 Andromeda - Tipo D**  
piscine al servizio di unità abitative monofamiliare, bifamiliari,  
trifamiliari e quadrifamiliari



*POOL KIT 6.00x12.00 m Andromeda - Type D*  
*pools for buildings (houses, blocks of flats)*  
*with up to four apartments*

Codice Code	Altezza pannelli altezza acqua Panel height - Water height	Perimetro Perimeter	Area Surface	Volume Volume	Rivestimento in rotoli h 165 Azzurro Pool lining - rolls h 165, Light Blue	Filtrazione mc/h v 50 Filtration cu. m/h v 50	Consumo in kw Consumption in kW	Aqua flex tubo rotoli mt 25 Aqua flex pipe, 25 m rolls	Vasca di compenso m <sup>3</sup> Compensation tank cu. m	Aspirafango Mud suction nozzle	N° bocchette No. of nozzles	N° presa di f. No. of main drains	N° fari led bianchi e blue No. of white and blue LED lights	Listino Price List
KDBZA136	123	31.98	67.68	83.25	4	22	1.5	4	5	1	4	1	3	€ 29.115,00
KDBZA137	133	31.98	67.68	90.02	4	22	1.5	4	5	1	4	1	3	€ 29.700,00



## OPTIONAL

Codice/Code	Descrizione/Description	Price
107101702	Vasca di compenso prefabbricata completa 10.000 lt/Complete pre-fabricated compensation tank 10.000 lt	€ 5.730,00
ADSALT2100	Sterilizzatore Aqua Salt 100mc + pH/ Aqua Salt Steriliser 100mc + pH	€ 1.840,00
ADPS100	Pannello dosaggio pH - Rx/Dosing panel pH - Rx	€ 1.446,12
700800305	Pompa di calore 2,0HP/Heat pump 2,0HP	€ 2.816,00
KCIT134	Copertura invernale completa/Complete winter covering	€ 1.210,00
200300014	Lampada LED multicolor/Multi coloured LED lamp	€ 367,65
200300013	Lampada LED bianca/White LED lamp	€ 220,00



## APPROFONDIMENTI/ DETAILS

<http://aqua.quickkris.com/pool-kit-mt-6-00x-12-00-andromeda-tipo-d/>



## QR code

Fotografa il codice con lo smartphone e vai direttamente all'approfondimento

Scan the code with your smartphone to obtain more detailed information

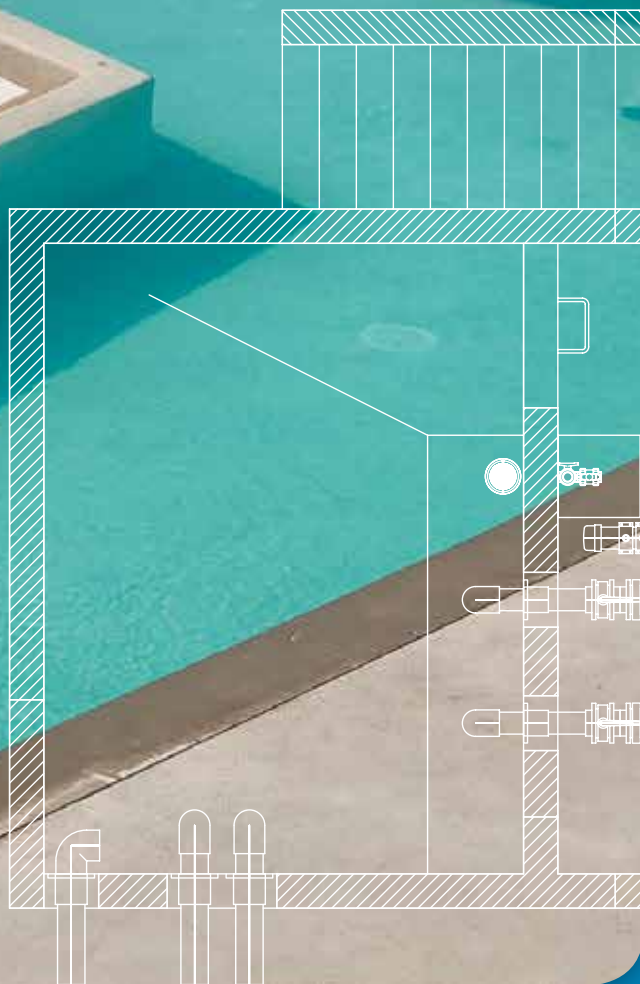
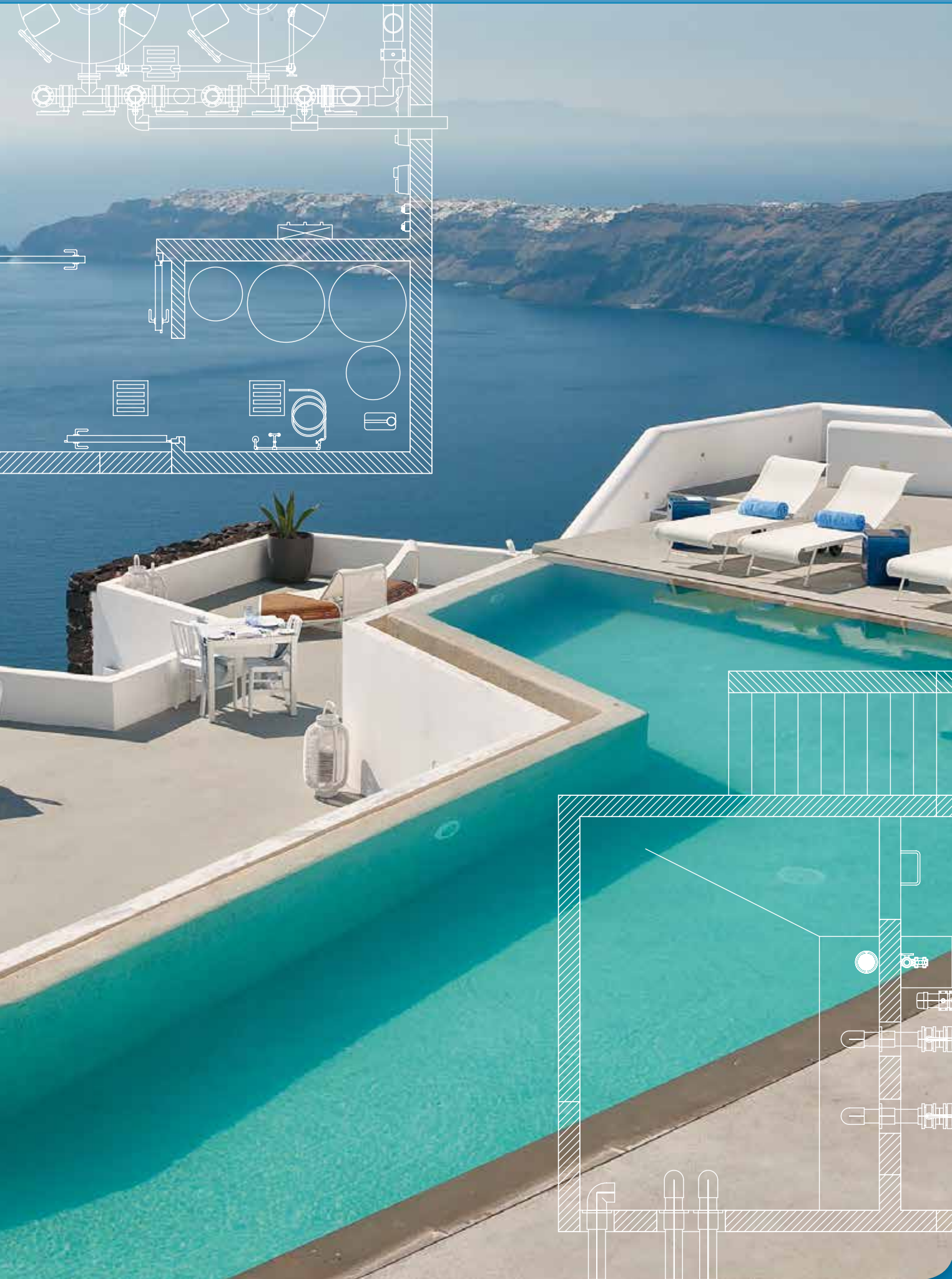

## PUBBLICA TIPO A2

A2

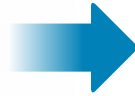

## PUBBLICA - TIPO A2 - SKIMMER

PUBLIC - TYPE A2 - SKIMMER



## CAMPO DI UTILIZZO

Piscine ad uso collettivo: sono quelle inserite in strutture già adibite, in via principale, ad altre attività ricettive (per esempio alberghi, camping, complessi ricettivi, agriturismi e simili) nonché quelle al servizio della collettività (per esempio scuole, collegi, caserme, palestre e simili) accessibili ai soli ospiti, clienti, soci, o utenti della struttura stessa.



## CONTEXT OF USE

Pools for collective use: those included in the structures already engaged, primarily, to other accommodation facility (example hotels, camping, cottage and similar) as well those at the public (example school, boarding school, barracks, gym and similar) accessible only at the guests customers, partners or users.



## CARATTERISTICHE TECNICHE

## 1) STRUTTURA

Tecnologia a Skimmer H 120cm - 130cm - 140cm - 150cm  
Altezza Aqua > 140cm necessità presenza del bagnino  
Tempi di filtrazione differenti a seconda dell'altezza di Aqua  
(vedi tab. pag 135)

## 2) RIVESTIMENTO

PVC armato

## 3) CIRCOLAZIONE

L'immissione in vasca può avvenire dalle pareti o dal fondo, purché si garantisca l'omogeneizzazione.  
I sistemi di ripresa immersi e le prese di fondo devono essere sempre collegate in coppia ad una distanza minima di 2 mt.

## 4) FILTRAZIONE

- Diametro minimo Ø 500mm
- Altezza minima Ø 1000mm
- Altezza minima letto filtrante Ø 600mm
- Velocità di filtrazione  $\delta 35mc/h$
- Pressione di collaudo deve essere  $\epsilon 1,5$  volte superiore alla pressione massima di esercizio.
- Pressione massima di esercizio con un minimo di 350Kpa.
- Deve essere previsto un numero di filtri  $\geq 2$ ; tutti i filtri devono avere medesime caratteristiche
- Deve essere previsto un numero minimo di pompe, tante quante sono i filtri più 1 di scorta.
- Devono essere previsti minimo 5 punti di lettura

## 5) ILLUMINAZIONE

- Led

## 6) QUADRO ELETTRICO

- Trifasi



## TECHNICAL FEATURES

## 1) STRUCTURE

Skimmer technology H 120cm - 130cm - 140cm - 150cm  
Water height > 140cm need the presence of the lifeguard  
Filtration time different depending on the water height (see tab. page 135)

## 2) COATING

Reinforced PVC

## 3) CIRCULATION

The return of the water in the pool can be from the wall or from the bottom, provided it is ensure homogenization.  
The suction of the swimming pool and the main drain must always be connected in pairs at a minimum distance of 2 meters.

## 4) FILTRATION

- Minimum Diameter Ø 500mm
- Minimum height Ø 1000mm
- Minimum height filtration material Ø 600mm
- Filtration speed  $\delta 35mc/h$
- Pressure test must be  $\epsilon 1,5$  time higher than the maximum pressure.
- Maximum with a minimum of 350Kpa.
- Must be provided a minimum number of filters  $\geq 2$ ; all the filters must have the same characteristic
- Must be provided a minimum number of pumps, as many filters plus 1 spare.
- Must be provided at least 5 check points.

## 5) LIGHTING

- Led

## 6) ELECTRICAL BOARD

- Three-phase



**NORMATIVE**

Normativa NTC 2008 - L. n°1086 del 05.11.1971: "Norme per la disciplina delle opere in conglomerato cementizio armato, normale e precompresso e in struttura metallica;  
Ordinanza n°3274 del 20.03.2003: "Primi elementi in materia di criteri generali per la classificazione sismica del territorio nazionale e di normative tecniche per la costruzione in zona sismica";  
D.M. del 14.01.2008: "Norme Tecniche per le costruzioni NTC 2008";  
Circolare ministeriale n°617 del 27.02.2009: "Istruzioni per l'applicazione delle Norme Tecniche per le Costruzioni";  
EC3: EUROCODICE 3 EN 1993 1-3; 1-5; 1-2.  
Carichi e movimentazione D. Lgs. 81/08 (ex 626). (MAX KG.30)  
UNI EN 10637:2006  
UNI EN 13451-1:2002 e 13451-3:2002  
UNI EN 13451-1:2002 e 13451-1:2002

**STANDARDS**

NTC 2008 Standard - Italian Law no. 1086 of 05.11.1971: "Regulations for works in reinforced concrete, pre-stressed reinforced concrete and metal structures;  
Italian Order no.3274 of 20.03.2003: "Basic notions on general seismic classification criteria for the national territory and technical rules for construction in seismic areas";  
Italian Ministerial Decree of 14.01.2008: "Technical Standards for Construction NTC 2008";  
Italian Ministerial Circular no. 617 of 27.02.2009: "Instructions for the application of Technical Standards for Construction";  
EC3: EUROCODE 3 EN 1993 1-3; 1-5; 1-2.  
Loads and handling - Italian Legislative Decree 81/08 (ex 626). (MAX KG.30)  
UNI EN 10637:2006 - UNI EN 13451-1:2002 and 13451-3:2002  
UNI EN 13451-1:2002 and 13451-1:2002

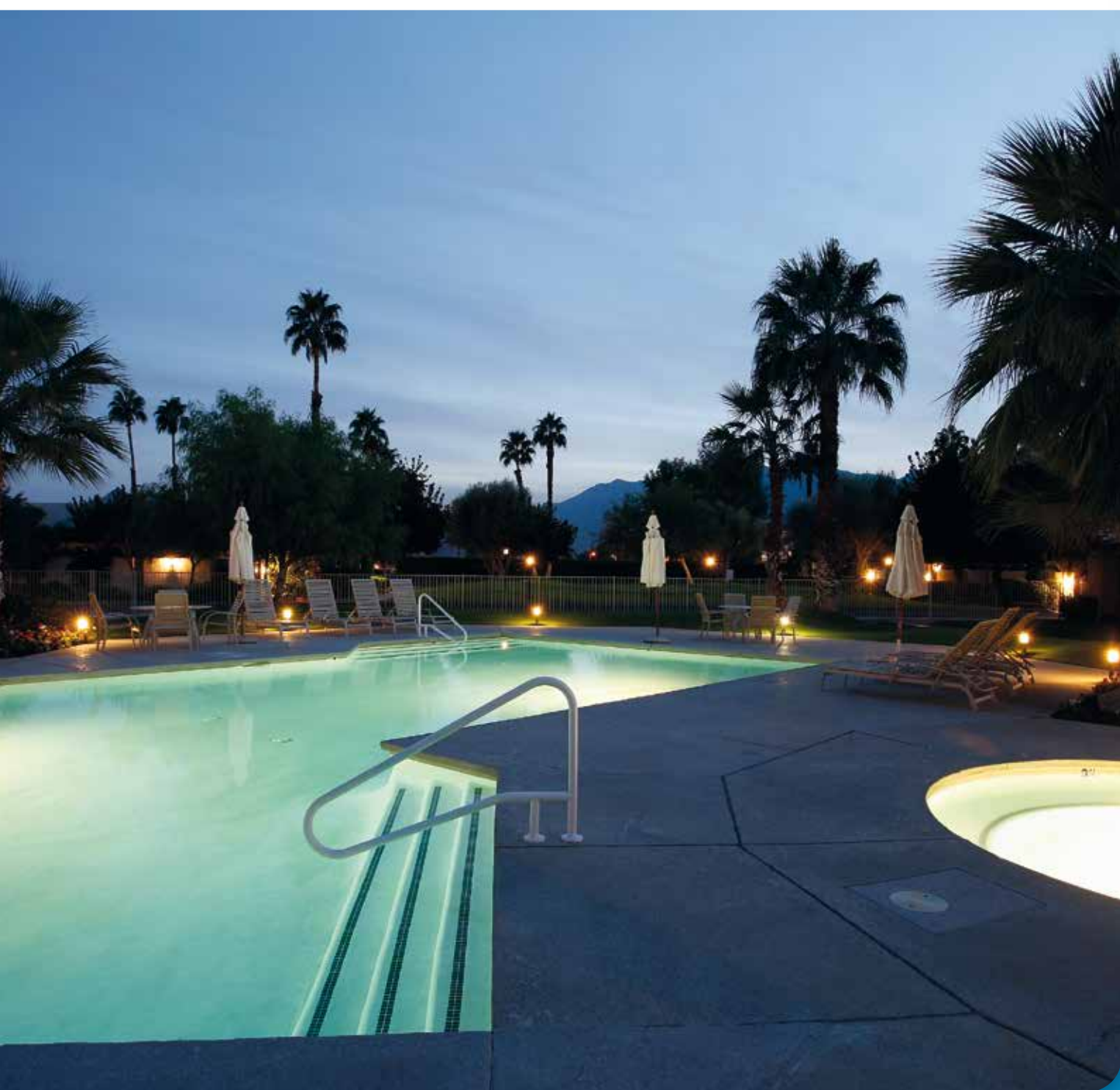

## PUBBLICA TIPO A2

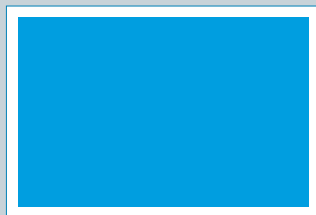

A2



## POOL KIT mt 4.00x8.00 - Tipo A2

piscine ad uso collettivo, inserite in strutture adibite principalmente ad altre attività ricettive o al servizio della collettività (alberghi, agriturismo, campeggi, palestre, scuole, caserme, etc.)

## POOL KIT 4.00x8.00 m - Type A2

pools for collective use, installed in facilities mainly offering other hospitality or public services (hotels, farm holiday houses, camping sites, gyms, schools, army barracks, etc.).

Codice Code	Altezza pannelli altezza acqua Panel height - Water height	Scala recessa Roman steps	Perimetro Perimeter	Area Surface	Volume Volume	Rivestimento in rotoli h 1.65 Azzurro Pool lining - rolls h.1.65, Light Blue	Rivestimento mq. Azzurro antiscivolo Pool lining sq. m Light Blue, non-slip	Filtrazione mc/h v 35 Filtration cu. m/h v 35	Consumo in kw Consumption in kW	Aqua flex tubo rotoli mt 25 Aqua flex pipe, 25 m rolls	N° skimmer No. of skimmers	Regolatore di livello Level adjuster	N° bocchette No. of nozzles	N° presa di f. No. of main drains	N° fari led bianchi e blue No. of white and blue LED lights	Listino Price list
<b>Skimmer sfioratore/Overflow skimmer</b>																
KAKDA100	125-130		24.00	32.00	40.00	2		9.00x2	0.50x3	4	2	1	2	2	2	€ 19.545,00
KAKDA101	125-130	R 1.5	26.46	36.66	42.91	2½	8.25	9.00x2	0.50x3	4	2	1	3	2	2	€ 21.645,00
KAKDA102	125-130	1.6x2.4	27.20	35.84	42.40	2½	8.25	9.00x2	0.50x3	4	2	1	3	2	2	€ 21.585,00
KAKDA103	135-140		24.00	32.00	43.20	2		9.00x2	0.50x3	4	2	1	2	2	2	€ 19.735,00
KAKDA104	135-140	R 1.5	26.46	36.66	46.34	2½	8.25	9.00x2	0.50x3	4	2	1	3	2	2	€ 21.485,00
KAKDA105	135-140	1.6x2.4	27.20	35.84	45.79	2½	8.25	9.00x2	0.50x3	4	2	1	3	2	2	€ 21.795,00
<b>Skimmer angolare/Corner skimmer</b>																
KAKAA100	125-130		24.00	32.00	40.00	2		9.00x2	0.50x3	4	2	1	2	2	2	€ 19.600,00
KAKAA101	125-130	R 1.5	26.46	36.66	42.91	2½	8.25	9.00x2	0.50x3	4	2	1	3	2	2	€ 21.975,00
KAKAA102	125-130	1.6x2.4	27.20	35.84	42.40	2½	8.25	9.00x2	0.50x3	4	2	1	3	2	2	€ 21.895,00
KAKAA103	135-140		24.00	32.00	43.20	2		9.00x2	0.50x3	4	2	1	2	2	2	€ 19.790,00
KAKAA104	135-140	R 1.5	26.46	36.66	46.34	2½	8.25	9.00x2	0.50x3	4	2	1	3	2	2	€ 22.185,00
KAKAA105	135-140	1.6x2.4	27.20	35.84	45.79	2½	8.25	9.00x2	0.50x3	4	2	1	3	2	2	€ 22.105,00
<b>Skimmer classic/Skimmer classic</b>																
KAKCA100	120-130		24.00	32.00	38.40	2		9.00x2	0.50x3	4	2	1	2	2	2	€ 19.600,00
KAKCA101	120-130	R 1.5	26.46	36.66	43.99	2½	8.25	9.00x2	0.50x3	4	2	1	3	2	2	€ 21.725,00
KAKCA102	120-130	1.6x2.4	27.20	35.84	43.01	2½	8.25	9.00x2	0.50x3	4	2	1	3	2	2	€ 21.645,00
KAKCA103	140-150		24.00	32.00	44.80	2		9.00x2	0.50x3	4	2	1	2	2	2	€ 19.795,00
KAKCA104	140-150	R 1.5	26.46	36.66	50.33	2½	8.25	9.00x2	0.50x3	4	2	1	3	2	2	€ 21.890,00
KAKCA105	140-150	1.6x2.4	27.20	35.84	50.18	2½	8.25	9.00x2	0.50x3	4	2	1	3	2	2	€ 21.855,00



## OPTIONAL

Codice/Code	Descrizione/Description	Price
ADSALT2050	Sterilizzatore Aqua Salt 50mc + pH/Aqua Salt Steriliser 50mc + pH	€ 1.700,00
ADPS200	Pannello dosaggio pH - CL/Dosing panel pH - CL	€ 2.726,20
700800304	Pompa di calore 1,5 HP/Heat pump 1.5 HP	€ 2.256,00
KASP50	Kit Aspirafango/Mud suction kit	€ 200,00
KCIT101	Copertura invernale completa/Complete winter covering	€ 580,00
KCIT109	Copertura invernale R 1,5 con scala romana/Winter covering with roman steps R1.5	€ 753,00
KCIT117	Copertura invernale con scala rettangolare 1,6x2,4/Winter covering with rectangular steps 1.6x2.4	€ 720,00
200300014	Lampada LED multicolor/Multi coloured LED lamp	€ 367,65
200300013	Lampada LED bianca/White LED lamp	€ 220,00



## APPROFONDIMENTI/ DETAILS

<http://aqua.quickris.com/pool-kit-mt-4-00x8-00-tipo-a2/>



## QR code

Fotografa il codice con lo smartphone e vai direttamente all'approfondimento

Scan the code with your smartphone to obtain more detailed information

## PUBBLICA TIPO A2

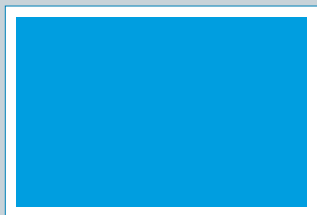

A2



## POOL KIT mt 4.80x9.60 - Tipo A2

piscine ad uso collettivo, inserite in strutture adibite principalmente ad altre attività ricettive o al servizio della collettività (alberghi, agriturismi, campeggi, palestre, scuole, caserme, etc.)

## POOL KIT 4.80x9.60 m - Type A2

pools for collective use, installed in facilities mainly offering other hospitality or public services (hotels, farm holiday houses, camping sites, gyms, schools, army barracks, etc.).

Codice Code	Altezza pannelli altezza acqua Panel height - Water height	Scala recessa Roman steps	Perimetro Perimeter	Area Surface	Volume Volume	Rivestimento in rotoli h 1.65 Azzurro Pool lining - rolls h.1.65, Light Blue	Rivestimento mq. Azzurro antiscivolo Pool lining sq. m Light Blue, non-slip	Filtrazione mc/h v 35 Filtration cu. m/h v.35	Consumo in kW Consumption in kW	Aqua flex tubo rotoli mt 25 Aqua flex pipe, 25 m rolls	N° skimmer No. of skimmers	Regolatore di livello Level adjuster	N° bocchette No. of nozzles	N° presa di f. No. of main drains	N° fari led bianchi e blue No. of white and blue LED lights	Listino Price list
<b>Skimmer sfioratore/Overflow skimmer</b>																
KAKDA106	125-130		28.80	46.08	57.60	2½		15x2	1.1x3	4	3	1	3	2	2	€ 23.970,00
KAKDA107	125-130	R 1.5	31.26	50.74	60.51	3	8.25	15x2	1.1x3	5	3	1	4	2	2	€ 26.535,00
KAKDA108	125-130	1.6x2.4	32.00	49.92	60.00	3	8.25	15x2	1.1x3	5	3	1	4	2	2	€ 26.245,00
KAKDA109	135-140		28.80	46.08	62.21	2½		15x2	1.1x3	4	3	1	3	2	2	€ 24.190,00
KAKDA110	135-140	R 1.5	31.26	50.74	65.35	3	8.25	15x2	1.1x3	5	3	1	4	2	2	€ 26.800,00
KAKDA111	135-140	1.6x2.4	32.00	49.92	64.80	3	8.25	15x2	1.1x3	5	3	1	4	2	2	€ 26.485,00
<b>Skimmer angolare/Corner skimmer</b>																
KAKA1006	125-130		28.80	46.08	57.60	2½		15x2	1.1x3	4	4	1	4	2	2	€ 24.180,00
KAKAA107	125-130	R 1.5	31.26	50.74	60.51	3	8.25	15x2	1.1x3	5	4	1	5	2	2	€ 26.760,00
KAKAA108	125-130	1.6x2.4	32.00	49.92	60.00	3	8.25	15x2	1.1x3	5	4	1	5	2	2	€ 26.450,00
KAKAA109	135-140		28.80	46.08	62.21	2½		15x2	1.1x3	4	4	1	4	2	2	€ 29.400,00
KAKAA110	135-140	R 1.5	31.26	50.74	65.35	3	8.25	15x2	1.1x3	5	4	1	5	2	2	€ 27.000,00
KAKAA111	135-140	1.6x2.4	32.00	49.92	64.80	3	8.25	15x2	1.1x3	5	4	1	5	2	2	€ 26.685,00
<b>Skimmer classic/Skimmer classic</b>																
KAKCA106	120-130		28.80	46.08	55.30	2½		15x2	1.1x3	4	3	1	3	2	2	€ 24.055,00
KAKCA107	120-130	R 1.5	31.26	50.74	58.10	3	8.25	15x2	1.1x3	5	3	1	4	2	2	€ 26.650,00
KAKCA108	120-130	1.6x2.4	32.00	49.92	57.60	3	8.25	15x2	1.1x3	5	3	1	4	2	2	€ 26.335,00
KAKCA109	140-150		28.80	46.08	64.52	2½		15x2	1.1x3	4	3	1	3	2	2	€ 24.275,00
KAKCA110	140-150	R 1.5	31.26	50.74	67.78	3	8.25	15x2	1.1x3	5	3	1	4	2	2	€ 26.845,00
KAKCA111	140-150	1.6x2.4	32.00	49.92	67.20	3	8.25	15x2	1.1x3	5	3	1	4	2	2	€ 26.575,00

**OPTIONAL**

Codice/Code	Descrizione/Description	Price
ADSALT2100	Sterilizzatore Aqua Salt 100mc + pH/Aqua Salt Steriliser 100mc + pH	€ 1.840,00
ADPS200	Pannello dosaggio pH - CL/Dosing panel pH - CL	€ 2.726,20
700800305	Pompa di calore 2,0 HP/Heat pump 2.0 HP	€ 2.816,00
KASP50	Kit Aspirafango/Mud suction kit	€ 200,00
KCIT102	Copertura invernale completa/Complete winter covering	€ 722,00
KCIT110	Copertura invernale R 1,5 con scala romana/Winter covering with roman steps R1.5	€ 930,00
KCIT118	Copertura invernale con scala rettangolare 1,6x2,4/Winter covering with rectangular steps 1.6x2.4	€ 890,00
200300014	Lampada LED multicolor/Multi coloured LED lamp	€ 367,65
200300013	Lampada LED bianca/White LED lamp	€ 220,00

**APPROFONDIMENTI/ DETAILS**
<http://aqua.quickris.com/pool-kit-mt-4-80x9-60-tipo-a2/>
**QR code**

Fotografa il codice con lo smartphone e vai direttamente all'approfondimento

Scan the code with your smartphone to obtain more detailed information

## PUBBLICA TIPO A2

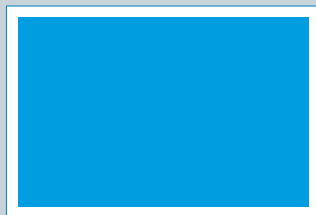

A2



## POOL KIT mt 5.00x10.00 - Tipo A2

piscine ad uso collettivo, inserite in strutture adibite principalmente ad altre attività ricettive o al servizio della collettività (alberghi, agriturismo, campeggi, palestre, scuole, caserme, etc.)

## POOL KIT 5.00x10.00 m - Type A2

pools for collective use, installed in facilities mainly offering other hospitality or public services (hotels, farm holiday houses, camping sites, gyms, schools, army barracks, etc.).

Codice Code	Altezza pannelli altezza acqua Panel height - Water height	Scala recessa Roman steps	Perimetro Perimeter	Area Surface	Volume Volume	Rivestimento in rotoli h 1.65 Azzurro Pool lining - rolls h.1.65, Light Blue	Rivestimento mq. Azzurro antiscivolo Pool lining sq. m Light Blue, non-slip	Filtrazione mc/h v 35 Filtration cu. m/h v 35	Consumo in kw Consumption in kW	Aqua flex tubo rotoli mt.25 Aqua flex pipe, 25 m rolls	N° skimmer No. of skimmers	Regolatore di livello Level adjuster	N° bocchette No. of nozzles	N° presa di f. No. of main drains	N° fari led bianchi e blue No. of white and blue LED lights	Listino Price list
<b>Skimmer sfioratore/Overflow skimmer</b>																
KAKDA112	125-130		30.00	50.00	62.50	3		15x2	1.1x3	4	3	1	3	2	2	€ 24.655,00
KAKDA113	125-130	R 1.5	32.46	54.66	65.41	3½	8.25	15x2	1.1x3	5	3	1	4	2	2	€ 27.630,00
KAKDA114	125-130	1.6x2.4	33.20	53.84	64.90	3½	8.25	15x2	1.1x3	5	3	1	4	2	2	€ 27.550,00
KAKDA115	135-140		30.00	50.00	67.50	3		15x2	1.1x3	4	3	1	3	2	2	€ 25.500,00
KAKDA116	135-140	R 1.5	32.46	54.66	70.64	3½	8.25	15x2	1.1x3	5	3	1	4	2	2	€ 27.870,00
KAKDA117	135-140	1.6x2.4	33.20	53.84	70.09	3½	8.25	15x2	1.1x3	5	3	1	4	2	2	€ 27.795,00
<b>Skimmer angolare/Corner skimmer</b>																
KAKAA112	125-130		30.00	50.00	62.50	3		15x2	1.1x3	4	3	1	4	2	2	€ 24.870,00
KAKAA113	125-130	R 1.5	32.46	54.66	65.41	3½	8.25	15x2	1.1x3	5	3	1	5	2	2	€ 27.215,00
KAKAA114	125-130	1.6x2.4	33.20	53.84	64.90	3½	8.25	15x2	1.1x3	5	3	1	5	2	2	€ 27.135,00
KAKAA115	135-140		30.00	50.00	67.50	3		15x2	1.1x3	4	3	1	4	2	2	€ 25.710,00
KAKAA116	135-140	R 1.5	32.46	54.66	70.64	3½	8.25	15x2	1.1x3	5	3	1	5	2	2	€ 28.075,00
KAKAA117	135-140	1.6x2.4	33.20	53.84	70.09	3½	8.25	15x2	1.1x3	5	3	1	5	2	2	€ 27.995,00
<b>Skimmer classic/Skimmer classic</b>																
KAKCA112	120-130		30.00	50.00	60.00	3		15x2	1.1x3	4	3	1	3	2	2	€ 24.745,00
KAKCA113	120-130	R 1.5	32.46	54.66	62.80	3½	8.25	15x2	1.1x3	5	3	1	4	2	2	€ 27.100,00
KAKCA114	120-130	1.6x2.4	33.20	53.84	62.31	3½	8.25	15x2	1.1x3	5	3	1	4	2	2	€ 27.020,00
KAKCA115	140-150		30.00	50.00	70.00	3		15x2	1.1x3	4	3	1	3	2	2	€ 25.590,00
KAKCA116	140-150	R 1.5	32.46	54.66	73.26	3½	8.25	15x2	1.1x3	5	3	1	4	2	2	€ 27.915,00
KAKCA117	140-150	1.6x2.4	33.20	53.84	72.69	3½	8.25	15x2	1.1x3	5	3	1	4	2	2	€ 27.885,00



## OPTIONAL

Codice/Code	Descrizione/Description	Price
ADSALT2100	Sterilizzatore Aqua Salt 100mc + pH/Aqua Salt Steriliser 100mc + pH	€ 1.840,00
ADPS200	Pannello dosaggio pH - CL/Dosing panel pH - CL	€ 2.726,20
700800305	Pompa di calore 2,0 HP/Heat pump 2.0 HP	€ 2.816,00
KASP50	Kit Aspirafango/Mud suction kit	€ 200,00
KCIT103	Copertura invernale completa/Complete winter covering	€ 757,00
KCIT111	Copertura invernale R 1,5 con scala romana/Winter covering with roman steps R1.5	€ 980,00
KCIT119	Copertura invernale con scala rettangolare 1,6x2,4/Winter covering with rectangular steps 1.6x2.4	€ 930,00
200300014	Lampada LED multicolor/Multi coloured LED lamp	€ 367,65
200300013	Lampada LED bianca/White LED lamp	€ 220,00



## APPROFONDIMENTI/ DETAILS

<http://aqua.quickris.com/pool-kit-mt-5-00x10-00-tipo-a2/>



## QR code

Fotografa il codice con lo smartphone e vai direttamente all'approfondimento

Scan the code with your smartphone to obtain more detailed information



## PUBBLICA TIPO A2

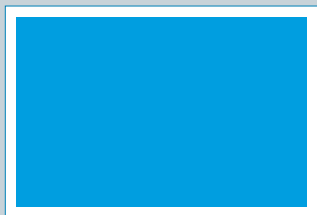

A2



## POOL KIT mt 5.60x11.20 - Tipo A2

piscine ad uso collettivo, inserite in strutture adibite principalmente ad altre attività ricettive o al servizio della collettività (alberghi, agriturismi, campeggi, palestre, scuole, caserme, etc.)

## POOL KIT 5.60x11.20 m - Type A2

pools for collective use, installed in facilities mainly offering other hospitality or public services (hotels, farm holiday houses, camping sites, gyms, schools, army barracks, etc.).

Codice Code	Altezza pannelli altezza acqua Panel height - Water height	Scala recessa Roman steps	Perimetro Perimeter	Area Surface	Volume Volume	Rivestimento in rotoli h 1.65 Azzurro Pool lining - rolls h.1.65, Light Blue	Rivestimento mq. Azzurro antiscivolo Pool lining sq. m Light Blue, non-slip	Filtrazione mc/h v 35 Filtration cu. m/h v.35	Consumo in kW Consumption in kW	Aqua flex tubo rotoli mt 25 Aqua flex pipe, 25 m rolls	N° skimmer No. of skimmers	Regolatore di livello Level adjuster	N° bocchette No. of nozzles	N° presa di f. No. of main drains	N° fari led bianchi e blue No. of white and blue LED lights	Listino Price list
<b>Skimmer sfioratore/Overflow skimmer</b>																
KAKDA118	125-130		33.60	62.72	78.40	3½		15x2	1.1x3	5	4	1	4	2	3	€ 27.355,00
KAKDA119	125-130	R 1.5	36.06	67.38	81.31	4	8.25	15x2	1.1x3	6	4	1	5	2	3	€ 29.525,00
KAKDA120	125-130	1.6x2.4	36.80	66.56	80.80	4	8.25	15x2	1.1x3	6	4	1	5	2	3	€ 29.420,00
KAKDA121	135-140		33.60	62.72	84.67	3½		15x2	1.1x3	5	4	1	4	2	3	€ 27.600,00
KAKDA122	135-140	R 1.5	36.06	67.38	87.82	4	8.25	15x2	1.1x3	5	4	1	5	2	3	€ 29.790,00
KAKDA123	135-140	1.6x2.4	36.80	66.56	87.26	4	8.25	15x2	1.1x3	6	4	1	5	2	3	€ 29.685,00
<b>Skimmer angolare/Corner skimmer</b>																
KAKA118	125-130		33.60	62.72	78.40	3½		15x2	1.1x3	5	4	1	4	2	3	€ 24.155,00
KAKAA119	125-130	R 1.5	36.06	67.38	81.31	4	8.25	15x2	1.1x3	6	4	1	5	2	3	€ 26.480,00
KAKAA120	125-130	1.6x2.4	36.80	66.56	80.80	4	8.25	15x2	1.1x3	6	4	1	5	2	3	€ 26.370,00
KAKAA121	135-140		33.60	62.72	84.67	3½		15x2	1.1x3	5	4	1	4	2	3	€ 24.400,00
KAKAA122	135-140	R 1.5	36.06	67.38	87.82	4	8.25	15x2	1.1x3	5	4	1	5	2	3	€ 26.745,00
KAKAA123	135-140	1.6x2.4	36.80	66.56	87.26	4	8.25	15x2	1.1x3	6	4	1	5	2	3	€ 26.635,00
<b>Skimmer classic/Skimmer classic</b>																
KAKCA118	120-130		33.60	62.72	75.27	3½		15x2	1.1x3	5	4	1	4	2	3	€ 27.470,00
KAKCA119	120-130	R 1.5	36.06	67.38	80.86	4	8.25	15x2	1.1x3	6	4	1	5	2	3	€ 29.615,00
KAKCA120	120-130	1.6x2.4	36.80	66.56	79.88	4	8.25	15x2	1.1x3	6	4	1	5	2	3	€ 29.510,00
KAKCA121	140-150		33.60	62.72	87.81	3½		15x2	1.1x3	5	4	1	4	2	3	€ 27.715,00
KAKCA122	140-150	R 1.5	36.06	67.38	91.07	4	8.25	22x2	1.1x3	6	4	1	5	2	3	€ 30.245,00
KAKCA123	140-150	1.6x2.4	36.80	66.56	90.50	4	8.25	22x2	1.1x3	6	4	1	5	2	3	€ 30.180,00

**OPTIONAL**

Codice/Code	Descrizione/Description	Price
ADSALT2100	Sterilizzatore Aqua Salt 100mc + pH/Aqua Salt Steriliser 100mc + pH	€ 1.840,00
ADPS200	Pannello dosaggio pH - CL/Dosing panel pH - CL	€ 2.726,20
700800306	Pompa di calore 2,5 HP/Heat pump 2.5 HP	€ 3.639,00
KASP50	Kit Aspirafango/Mud suction kit	€ 200,00
KCIT104	Copertura invernale completa/Complete winter covering	€ 878,00
KCIT112	Copertura invernale R 1,5 con scala romana/Winter covering with roman steps R1.5	€ 1.123,00
KCIT120	Copertura invernale con scala rettangolare 1,6x2,4/Winter covering with rectangular steps 1.6x2.4	€ 1.075,00
200300014	Lampada LED multicolor/Multi coloured LED lamp	€ 367,65
200300013	Lampada LED bianca/White LED lamp	€ 220,00

**APPROFONDIMENTI/ DETAILS**
<http://aqua.quickris.com/pool-kit-mt-5-60x11-20-tipo-a2/>
**QR code**

Fotografa il codice con lo smartphone e vai direttamente all'approfondimento

Scan the code with your smartphone to obtain more detailed information

## PUBBLICA TIPO A2

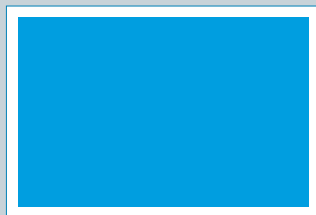

A2



## POOL KIT mt 6.00x12.00 - Tipo A2

piscine ad uso collettivo, inserite in strutture adibite principalmente ad altre attività ricettive o al servizio della collettività (alberghi, agriturismo, campeggi, palestre, scuole, caserme, etc.)

## POOL KIT 6.00x12.00 m - Type A2

pools for collective use, installed in facilities mainly offering other hospitality or public services (hotels, farm holiday houses, camping sites, gyms, schools, army barracks, etc.).

Codice Code	Altezza pannelli altezza acqua Panel height - Water height	Scala recessa Roman steps	Perimetro Perimeter	Area Surface	Volume Volume	Rivestimento in rotoli h 1.65 Azzurro Pool lining - rolls h.1.65, Light Blue	Rivestimento mq. Azzurro antiscivolo Pool lining sq. m Light Blue, non-slip	Filtrazione mc/h v 35 Filtration cu. m/h v 35	Consumo in kw Consumption in kW	Aqua flex tubo rotoli mt 25 Aqua flex pipe, 25 m rolls	N° skimmer No. of skimmers	Regolatore di livello Level adjuster	N° bocchette No. of nozzles	N° presa di f. No. of main drains	N° fari led bianchi e blue No. of white and blue LED lights	Listino Price list
<b>Skimmer sfioratore/Overflow skimmer</b>																
KAKDA124	125-130		36.00	72.00	90.00	4		15x2	1.1x3	5	4	1	4	2	3	€ 28.805,00
KAKDA125	125-130	R 1.5	38.46	76.66	92.91	4	8.25	22x2	1.1x3	6	4	1	5	2	3	€ 30.520,00
KAKDA126	125-130	1.6x2.4	39.20	75.84	92.40	4	8.25	22x2	1.1x3	6	4	1	5	2	3	€ 30.930,00
KAKDA127	135-140		36.00	72.00	97.20	4		22x2	1.1x3	5	4	1	4	2	3	€ 29.505,00
KAKDA128	135-140	R 1.5	38.46	76.66	100.34	4	8.25	22x2	1.1x3	6	4	1	5	2	3	€ 31.415,00
KAKDA129	135-140	1.6x2.4	39.20	75.84	99.79	4	8.25	22x2	1.1x3	6	4	1	5	2	3	€ 31.220,00
<b>Skimmer angolare/Corner skimmer</b>																
KAKAA124	125-130		36.00	72.00	90.00	4		15x2	1.1x3	5	4	1	4	2	3	€ 28.735,00
KAKAA125	125-130	R 1.5	38.46	76.66	92.91	4	8.25	22x2	1.1x3	6	4	1	5	2	3	€ 30.555,00
KAKAA126	125-130	1.6x2.4	39.20	75.84	92.40	4	8.25	22x2	1.1x3	6	4	1	5	2	3	€ 30.950,00
KAKAA127	135-140		36.00	72.00	97.20	4		22x2	1.1x3	5	4	1	4	2	3	€ 29.435,00
KAKAA128	135-140	R 1.5	38.46	76.66	100.34	4	8.25	22x2	1.1x3	6	4	1	5	2	3	€ 31.450,00
KAKAA129	135-140	1.6x2.4	39.20	75.84	99.79	4	8.25	22x2	1.1x3	6	4	1	5	2	3	€ 31.240,00
<b>Skimmer classic/Skimmer classic</b>																
KAKCA124	120-130		36.00	72.00	86.40	4		15x2	1.1x3	5	4	1	4	2	3	€ 28.920,00
KAKCA125	120-130	R 1.5	38.46	76.66	89.20	4	8.25	15x2	1.1x3	6	4	1	5	2	3	€ 30.205,00
KAKCA126	120-130	1.6x2.4	39.20	75.84	88.71	4	8.25	15x2	1.1x3	6	4	1	5	2	3	€ 30.600,00
KAKCA127	140-150		36.00	72.00	100.80	4		22x2	1.1x3	5	4	1	4	2	3	€ 29.625,00
KAKCA128	140-150	R 1.5	38.46	76.66	107.33	4	8.25	22x2	1.1x3	6	4	1	5	2	3	€ 31.550,00
KAKCA129	140-150	1.6x2.4	39.20	75.84	103.49	4	8.25	22x2	1.1x3	6	4	1	5	2	3	€ 32.050,00



## OPTIONAL

Codice/Code	Descrizione/Description	Price
ADSALT2100	Sterilizzatore Aqua Salt 100mc + pH/Aqua Salt Steriliser 100mc + pH	€ 1.840,00
ADPS200	Pannello dosaggio pH - CL/Dosing panel pH - CL	€ 2.726,20
700800306	Pompa di calore 2,5 HP/Heat pump 2.5 HP	€ 3.639,00
KASP50	Kit Aspirafango/Mud suction kit	€ 200,00
KCIT105	Copertura invernale completa/Complete winter covering	€ 960,00
KCIT113	Copertura invernale R 1,5 con scala romana/Winter covering with roman steps R1.5	€ 1.230,00
KCIT121	Copertura invernale con scala rettangolare 1,6x2,4/Winter covering with rectangular steps 1.6x2.4	€ 1.166,00
200300014	Lampada LED multicolor/Multi coloured LED lamp	€ 367,65
200300013	Lampada LED bianca/White LED lamp	€ 220,00



## APPROFONDIMENTI/ DETAILS

<http://aqua.quickris.com/pool-kit-mt-6-00x12-00-tipo-a2/>



## QR code

Fotografa il codice con lo smartphone e vai direttamente all'approfondimento

Scan the code with your smartphone to obtain more detailed information

## PUBBLICA TIPO A2

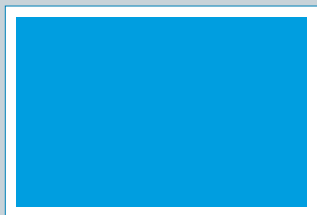

A2



## POOL KIT mt 6.40x12.80 - Tipo A2

piscine ad uso collettivo, inserite in strutture adibite principalmente ad altre attività ricettive o al servizio della collettività (alberghi, agriturismi, campeggi, palestre, scuole, caserme, etc.)

## POOL KIT 6.40x12.80 m - Type A2

pools for collective use, installed in facilities mainly offering other hospitality or public services (hotels, farm holiday houses, camping sites, gyms, schools, army barracks, etc.).

Codice Code	Altezza pannelli altezza acqua Panel height - Water height	Scala recessa Roman steps	Perimetro Perimeter	Area Surface	Volume Volume	Rivestimento in rotoli h 1.65 Azzurro Pool lining - rolls h.1.65, Light Blue	Rivestimento mq. Azzurro antiscivolo Pool lining sq. m Light Blue, non-slip	Filtrazione mc/h v 35 Filtration cu. m/h v.35	Consumo in kW Consumption in kW	Aqua flex tubo rotoli mt 25 Aqua flex pipe, 25 m rolls	N° skimmer No. of skimmers	Regolatore di livello Level adjuster	N° bocchette No. of nozzles	N° presa di f. No. of main drains	N° fari led bianchi e blue No. of white and blue LED lights	Listino Price list
<b>Skimmer sfioratore/Overflow skimmer</b>																
KAKDA130	125-130		38.40	81.92	102.40	4½		22x2	1.5x3	6	5	1	5	2	4	€ 31.110,00
KAKDA131	125-130	R 1.5	40.86	86.58	105.31	5	8.25	22x2	1.5x3	7	5	1	6	2	4	€ 33.710,00
KAKDA132	125-130	1.6x2.4	41.60	85.76	104.80	5	8.25	22x2	1.5x3	7	5	1	6	2	4	€ 33.475,00
KAKDA133	135-140		38.40	81.92	110.59	4½		22x2	1.5x3	6	5	1	5	2	4	€ 31.385,00
KAKDA134	135-140	R 1.5	40.86	86.58	113.74	5	8.25	22x2	1.5x3	7	5	1	6	2	4	€ 34.010,00
KAKDA135	135-140	1.6x2.4	41.60	85.76	113.18	5	8.25	22x2	1.5x3	7	5	1	6	2	4	€ 33.765,00
<b>Skimmer angolare/Corner skimmer</b>																
KAKAA130	125-130		38.40	81.92	102.40	4½		22x2	1.5x3	6	5	1	5	2	4	€ 31.150,00
KAKAA131	125-130	R 1.5	40.86	86.58	105.31	5	8.25	22x2	1.5x3	7	6	1	6	2	4	€ 33.710,00
KAKAA132	125-130	1.6x2.4	41.60	85.76	104.80	5	8.25	22x2	1.5x3	7	6	1	6	2	4	€ 33.110,00
KAKAA133	135-140		38.40	81.92	110.59	4½		22x2	1.5x3	6	5	1	5	2	4	€ 31.425,00
KAKAA134	135-140	R 1.5	40.86	86.58	113.74	5	8.25	22x2	1.5x3	7	6	1	6	2	4	€ 34.010,00
KAKAA135	135-140	1.6x2.4	41.60	85.76	113.18	5	8.25	22x2	1.5x3	7	6	1	6	2	4	€ 33.390,00
<b>Skimmer classic/Skimmer classic</b>																
KAKCA130	120-130		38.40	81.92	98.31	4½		22x2	1.5x3	6	5	1	5	2	4	€ 31.260,00
KAKCA131	120-130	R 1.5	40.86	86.58	101.10	5	8.25	22x2	1.5x3	7	5	1	6	2	4	€ 33.840,00
KAKCA132	120-130	1.6x2.4	41.60	85.76	100.61	5	8.25	22x2	1.5x3	7	5	1	6	2	4	€ 33.625,00
KAKCA133	140-150		38.40	81.92	114.69	4½		22x2	1.5x3	6	5	1	5	2	4	€ 31.535,00
KAKCA134	140-150	R 1.5	40.86	86.58	117.95	5	8.25	22x2	1.5x3	7	5	1	6	2	4	€ 34.115,00
KAKCA135	140-150	1.6x2.4	41.60	85.76	117.38	5	8.25	22x2	1.5x3	7	5	1	6	2	4	€ 33.935,00

**OPTIONAL**

Codice/Code	Descrizione/Description	Price
ADSALT2150	Sterilizzatore Aqua Salt 150mc + pH/Aqua Salt Steriliser 150mc + pH	€ 2.190,00
ADPS200	Pannello dosaggio pH - CL/Dosing panel pH - CL	€ 2.726,20
700800307	Pompa di calore 3,0 HP/Heat pump 3.0 HP	€ 4.144,00
KASP50	Kit Aspirafango/Mud suction kit	€ 200,00
KCIT106	Copertura invernale completa/Complete winter covering	€ 1.054,00
KCIT114	Copertura invernale R 1,5 con scala romana/Winter covering with roman steps R1.5	€ 1.338,00
KCIT122	Copertura invernale con scala rettangolare 1,6x2,4/Winter covering with rectangular steps 1.6x2.4	€ 1.282,00
200300014	Lampada LED multicolor/Multi coloured LED lamp	€ 367,65
200300013	Lampada LED bianca/White LED lamp	€ 220,00

**APPROFONDIMENTI/ DETAILS**
<http://aqua.quickris.com/pool-kit-mt-6-40x12-80-tipo-a2/>
**QR code**

Fotografa il codice con lo smartphone e vai direttamente all'approfondimento

Scan the code with your smartphone to obtain more detailed information

## PUBBLICA TIPO A2

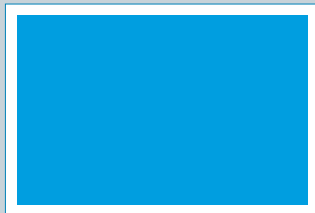

A2



## POOL KIT mt 7.00x14.00 - Tipo A2

piscine ad uso collettivo, inserite in strutture adibite principalmente ad altre attività ricettive o al servizio della collettività (alberghi, agriturismo, campeggi, palestre, scuole, caserme, etc.)

## POOL KIT 7.00x14.00 m - Type A2

pools for collective use, installed in facilities mainly offering other hospitality or public services (hotels, farm holiday houses, camping sites, gyms, schools, army barracks, etc.).

Codice Code	Altezza pannelli altezza acqua Panel height - Water height	Perimetro Perimeter	Area Surface	Volume Volume	Rivestimento in rotoli h 1.65 Azzurro Pool lining - rolls h 1.65: Light Blue	Filtrazione mc/h v 35 Filtration cu. m/h v 35	Consumo in kw Consumption in kW	Aqua flex tubo rotoli mt 25 Aqua flex pipe, 25 m rolls	N° skimmer No. of skimmers	Regolatore di livello Level adjuster	N° bocchette No. of nozzles	N° presa di f. No. of main drains	N° fari led bianchi e blue No. of white and blue LED lights	Listino Price List
Skimmer sfioratore/Overflow skimmer														
KAKDA136	125-130	42.00	98.00	122.50	5	22x2	1.1x3	6	5	1	5	2	4	€ 32.060,00
KAKDA137	135-140	42.00	98.00	132.50	5	22x2	1.1x3	6	5	1	5	2	4	€ 33.325,00
Skimmer angolare/Corner skimmer														
KAKAA136	125-130	42.00	98.00	122.50	5	22x2	1.1x3	6	5	1	5	2	4	€ 33.485,00
KAKAA137	135-140	42.00	98.00	132.50	5	22x2	1.1x3	6	5	1	5	2	4	€ 33.770,00
Skimmer classic/Skimmer classic														
KAKCA136	120-130	42.00	98.00	117.60	5	22x2	1.1x3	6	5	1	5	2	4	€ 33.185,00
KAKCA137	140-150	42.00	98.00	137.20	5	22x2	1.1x3	6	5	1	5	2	4	€ 33.470,00



## OPTIONAL

Codice/Code	Descrizione/Description	Price
ADSALT2150	Sterilizzatore Aqua Salt 150mc + pH/Aqua Salt Steriliser 150mc + pH	€ 2.190,00
ADPS201	Pannello dosaggio pH - CL/Dosing panel pH - CL	€ 2.774,94
700800307	Pompa di calore 3,0 HP/Heat pump 3.0 HP	€ 4.144,00
KASP50	Kit Aspirafango/Mud suction kit	€ 200,00
KCIT107	Copertura invernale completa/Complete winter covering	€ 1.185,00
KCIT115	Copertura invernale R 1,5 con scala romana/Winter covering with roman steps R1.5	€ 1.510,00
KCIT123	Copertura invernale con scala rettangolare 1,6x2,4/Winter covering with rectangular steps 1.6x2.4	€ 1.437,00
200300014	Lampada LED multicolor/Multi coloured LED lamp	€ 367,65
200300013	Lampada LED bianca/White LED lamp	€ 220,00



## APPROFONDIMENTI/ DETAILS

<http://aqua.quickris.com/pool-kit-mt-7-00x14-00-tipo-a2/>



## QR code

Fotografa il codice con lo smartphone e vai direttamente all'approfondimento

Scan the code with your smartphone to obtain more detailed information



## PUBBLICA TIPO A2



A2



## POOL KIT mt 4.00X8.00 Orione - Tipo A2

piscine ad uso collettivo, inserite in strutture adibite principalmente ad altre attività ricettive o al servizio della collettività (alberghi, agriturismi, campeggi, palestre, scuole, caserme, etc.)

## POOL KIT 4.00x8.00 m Orione - Type A2

pools for collective use, installed in facilities mainly offering other hospitality or public services (hotels, farm holiday houses, camping sites, gyms, schools, army barracks, etc.).

Codice Code	Altezza pannelli altezza acqua Panel height - Water height	Perimetro Perimeter	Area Surface	Volume Volume	Rivestimento in rotoli h 1.65 Azzurro Pool lining - rolls h.1.65, Light Blue	Filtrazione mc/h v 35 Filtration cu. m/h v.35	Consumo in kw Consumption in kW	Aqua flex tubo rotoli mt 25 Aqua flex pipe, 25 m rolls	N° skimmer No. of skimmers	Regolatore di livello Level adjuster	N° bocchette No. of nozzles	N° presa di f. No. of main drains	N° fari led bianchi e blue No. of white and blue LED lights	Listino Price List
Skimmer sfioratore/Overflow skimmer														
KAKDA138	125-130	22.28	30.28	37.85	2	9.0x2	0.50x3	4	2	1	2	2	2	€ 19.325,00
KAKDA139	135-140	22.28	30.28	40.88	2	9.0x2	0.50x3	4	2	1	2	2	2	€ 19.510,00
Skimmer classic/Skimmer classic														
KAKCA138	120-130	22.28	36.34	36.34	2	9.0x2	0.50x3	4	2	1	2	2	2	€ 19.385,00
KAKCA139	140-150	22.28	42.40	42.40	2	9.0x2	0.50x3	4	2	1	2	2	2	€ 19.570,00

**OPTIONAL**

Codice/Code	Descrizione/Description	Price
ADSALT2050	Sterilizzatore Aqua Salt 50mc + pH/Aqua Salt Steriliser 50mc + pH	€ 1.700,00
ADPS200	Pannello dosaggio pH - CL/Dosing panel pH - CL	€ 2.726,20
700800304	Pompa di calore 1,5 HP/Heat pump 1.5 HP	€ 2.256,00
KASP50	Kit Aspirafango/Mud suction kit	€ 200,00
KCIT124	Copertura invernale completa/Complete winter covering	€ 706,00
200300014	Lampada LED multicolor/Multi coloured LED lamp	€ 367,65
200300013	Lampada LED bianca/White LED lamp	€ 220,00

**APPROFONDIMENTI/ DETAILS**
<http://aqua.quickris.com/pool-kit-mt-4-00x8-00-orione-tipo-a2/>
**QR code**

Fotografa il codice con lo smartphone e vai direttamente all'approfondimento

Scan the code with your smartphone to obtain more detailed information

## PUBBLICA TIPO A2



A2



## POOL KIT mt 5.00X10.00 Orione - Tipo A2

piscine ad uso collettivo, inserite in strutture adibite principalmente ad altre attività ricettive o al servizio della collettività (alberghi, agriturismi, campeggi, palestre, scuole, caserme, etc.)

## POOL KIT 5.00x10.00 m Orione - Type A2

pools for collective use, installed in facilities mainly offering other hospitality or public services (hotels, farm holiday houses, camping sites, gyms, schools, army barracks, etc.).

Codice Code	Altezza pannelli altezza acqua Panel height - Water height	Perimetro Perimeter	Area Surface	Volume Volume	Rivestimento in rotoli h 1.65 Azzurro Pool lining - rolls h 1.65: Light Blue	Filtrazione mc/h v 35 Filtration cu. m/h v 35	Consumo in kw Consumption in kW	Aqua flex tubo rotoli mt 25 Aqua flex pipe, 25 m rolls	N° skimmer No. of skimmers	Regolatore di livello Level adjuster	N° bocchette No. of nozzles	N° presa di f. No. of main drains	N° fari led bianchi e blue No. of white and blue LED lights	Listino Price List
Skimmer sfioratore/Overflow skimmer														
KAKDA140	125-130	27.85	47.32	59.15	2½	15x2	1.1x3	4	3	1	3	2	2	€ 24.405,00
KAKDA141	135-140	27.85	47.32	63.89	2½	15x2	1.1x3	4	3	1	3	2	2	€ 24.630,00
Skimmer classic/Skimmer classic														
KAKCA140	120-130	27.85	47.32	56.79	2½	15x2	1.1x3	4	3	1	3	2	2	€ 24.445,00
KAKCA141	140-150	27.85	47.32	66.25	2½	15x2	1.1x3	4	3	1	3	2	2	€ 24.720,00



## OPTIONAL

Codice/Code	Descrizione/Description	Price
ADSALT2100	Sterilizzatore Aqua Salt 100mc + pH/Aqua Salt Steriliser 100mc + pH	€ 1.840,00
ADPS200	Pannello dosaggio pH - CL/Dosing panel pH - CL	€ 2.726,20
700800305	Pompa di calore 2,0 HP/Heat pump 2.0 HP	€ 2.816,00
KASP50	Kit Aspirafango/Mud suction kit	€ 200,00
KCIT125	Copertura invernale completa/Complete winter covering	€ 946,00
200300014	Lampada LED multicolor/Multi coloured LED lamp	€ 367,65
200300013	Lampada LED bianca/White LED lamp	€ 220,00



## APPROFONDIMENTI/ DETAILS

<http://aqua.quickris.com/pool-kit-mt-5-00x10-00-orione-tipo-a2/>



## QR code

Fotografa il codice con lo smartphone e vai direttamente all'approfondimento

Scan the code with your smartphone to obtain more detailed information

## PUBBLICA TIPO A2

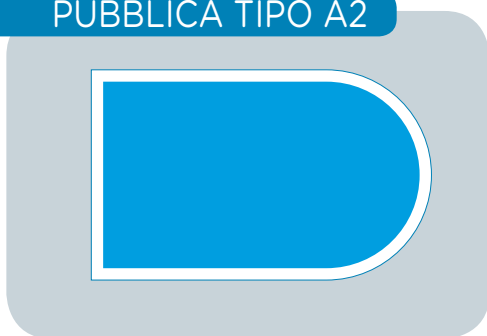

A2



## POOL KIT mt 6.00X12.00 Orione - Tipo A2

piscine ad uso collettivo, inserite in strutture adibite principalmente ad altre attività ricettive o al servizio della collettività (alberghi, agriturismi, campeggi, palestre, scuole, caserme, etc.)

## POOL KIT 6.00x12.00 m Orione - Type A2

pools for collective use, installed in facilities mainly offering other hospitality or public services (hotels, farm holiday houses, camping sites, gyms, schools, army barracks, etc.).

Codice Code	Altezza pannelli altezza acqua Panel height - Water height	Perimetro Perimeter	Area Surface	Volume Volume	Rivestimento in rotoli h 1.65 Azzurro Pool lining - rolls h.1.65, Light Blue	Filtrazione mc/h v 35 Filtration cu. m/h v.35	Consumo in kw Consumption in kW	Aqua flex tubo rotoli mt 25 Aqua flex pipe, 25 m rolls	N° skimmer No. of skimmers	Regolatore di livello Level adjuster	N° bocchette No. of nozzles	N° presa di f. No. of main drains	N° fari led bianchi e blue No. of white and blue LED lights	Listino Price List
Skimmer sfioratore/Overflow skimmer														
KAKDA142	125-130	33.42	68.14	85.18	3½	15x2	1.1x3	5	4	1	4	2	3	€ 27.725,00
KAKDA143	135-140	33.42	68.14	91.99	3½	22x2	1.1x3	5	4	1	4	2	3	€ 28.410,00
Skimmer classic/Skimmer classic														
KAKCA142	120-130	33.42	68.14	81.77	3½	15x2	1.1x3	5	4	1	4	2	3	€ 27.845,00
KAKCA143	140-150	33.42	68.14	95.40	3½	22x2	1.1x3	5	4	1	4	2	3	€ 28.530,00



## OPTIONAL

Codice/Code	Descrizione/Description	Price
ADSALT2100	Sterilizzatore Aqua Salt 100mc + pH/Aqua Salt Steriliser 100mc + pH	€ 1.840,00
ADPS200	Pannello dosaggio pH - CL/Dosing panel pH - CL	€ 2.726,20
700800305	Pompa di calore 2,0 HP/Heat pump 2.0 HP	€ 2.816,00
KASP50	Kit Aspirafango/Mud suction kit	€ 200,00
KCIT126	Copertura invernale completa/Complete winter covering	€ 1.222,00
200300014	Lampada LED multicolor/Multi coloured LED lamp	€ 367,65
200300013	Lampada LED bianca/White LED lamp	€ 220,00



## APPROFONDIMENTI/ DETAILS

<http://aqua.quickris.com/pool-kit-mt-6-00x12-00-orione-tipo-a2/>



## QR code

Fotografa il codice con lo smartphone e vai direttamente all'approfondimento

Scan the code with your smartphone to obtain more detailed information

## PUBBLICA TIPO A2

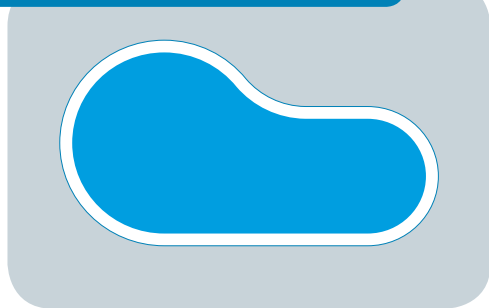

A2



## POOL KIT mt 4.00X8.00 Sirio - Tipo A2

piscine ad uso collettivo, inserite in strutture adibite principalmente ad altre attività ricettive o al servizio della collettività (alberghi, agriturismo, campeggi, palestre, scuole, caserme, etc.)

## POOL KIT 4.00x8.00m Sirio - Type A2

pools for collective use, installed in facilities mainly offering other hospitality or public services (hotels, farm holiday houses, camping sites, gyms, schools, army barracks, etc.).

Codice Code	Altezza pannelli altezza acqua Panel height - Water height	Perimetro Perimeter	Area Surface	Volume Volume	Rivestimento in rotoli h 1.65 Azzurro Pool lining - rolls h 1.65: Light Blue	Filtrazione mc/h v 35 Filtration cu. m/h v 35	Consumo in kw Consumption in kW	Aqua flex tubo rotoli mt 25 Aqua flex pipe, 25 m rolls	N° skimmer No. of skimmers	Regolatore di livello Level adjuster	N° bocchette No. of nozzles	N° presa di f. No. of main drains	N° fari led bianchi e blue No. of white and blue LED lights	Listino Price List
Skimmer sfioratore/Overflow skimmer														
KAKDA144	125-130	20.24	24.64	30.80	2	9.0x2	0.50x3	4	2	1	2	2	2	€ 18.845,00
KAKDA145	135-140	20.24	24.64	33.27	2	9.0x2	0.50x3	4	2	1	2	2	2	€ 19.175,00
Skimmer classic/Skimmer classic														
KAKCA144	120-130	20.24	24.64	29.57	2	9.0x2	0.50x3	4	2	1	2	2	2	€ 18.905,00
KAKCA145	140-150	20.24	24.64	34.50	2	9.0x2	0.50x3	4	2	1	2	2	2	€ 19.235,00



## OPTIONAL

Codice/Code	Descrizione/Description	Price
ADSALT2050	Sterilizzatore Aqua Salt 50mc + pH/Aqua Salt Steriliser 50mc + pH	€ 1.700,00
ADPS200	Pannello dosaggio pH - CL/Dosing panel pH - CL	€ 2.726,20
700800304	Pompa di calore 1,5 HP/Heat pump 1.5 HP	€ 2.256,00
KASP50	Kit Aspirafango/Mud suction kit	€ 200,00
KCIT127	Copertura invernale completa/Complete winter covering	€ 688,00
200300014	Lampada LED multicolor/Multi coloured LED lamp	€ 367,65
200300013	Lampada LED bianca/White LED lamp	€ 220,00



## APPROFONDIMENTI/ DETAILS

<http://aqua.quickris.com/pool-kit-mt-4-00x8-00-sirio-tipo-a2/>



## QR code

Fotografa il codice con lo smartphone e vai direttamente all'approfondimento

Scan the code with your smartphone to obtain more detailed information



## PUBBLICA TIPO A2

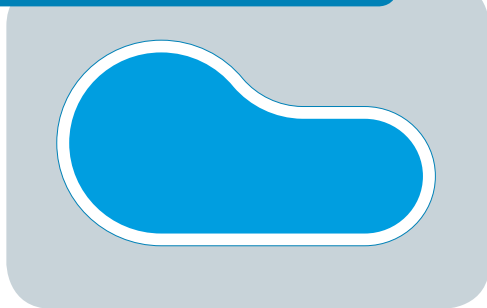

A2



## POOL KIT mt 5.00X10.00 Sirio - Tipo A2

piscine ad uso collettivo, inserite in strutture adibite principalmente ad altre attività ricettive o al servizio della collettività (alberghi, agriturismi, campeggi, palestre, scuole, caserme, etc.)

## POOL KIT 5.00x10.00 m Sirio - Type A2

pools for collective use, installed in facilities mainly offering other hospitality or public services (hotels, farm holiday houses, camping sites, gyms, schools, army barracks, etc.).

Codice Code	Altezza pannelli altezza acqua Panel height - Water height	Perimetro Perimeter	Area Surface	Volume Volume	Rivestimento in rotoli h 1.65 Azzurro Pool lining - rolls h 1.65, Light Blue	Filtrazione mc/h v 35 Filtration cu. m/h v 35	Consumo in kw Consumption in kW	Aqua flex tubo rotoli mt 25 Aqua flex pipe, 25 m rolls	N° skimmer No. of skimmers	Regolatore di livello Level adjuster	N° bocchette No. of nozzles	N° presa di f. No. of main drains	N° fari led bianchi e blue No. of white and blue LED lights	Listino Price List
Skimmer sfioratore/Overflow skimmer														
KAKDA146	125-130	20.24	39.56	49.95	2½	9.0x2	0.50x3	4	2	1	2	2	2	€ 21.090,00
KAKDA147	135-140	20.24	39.56	53.41	2½	9.0x2	0.50x3	4	2	1	2	2	2	€ 21.295,00
Skimmer classic/Skimmer classic														
KAKCA146	120-130	20.24	39.56	47.48	2½	9.0x2	0.50x3	4	2	1	2	2	2	€ 20.970,00
KAKCA147	140-150	20.24	39.56	55.39	2½	9.0x2	0.50x3	4	2	1	2	2	2	€ 21.355,00



## OPTIONAL

Codice/Code	Descrizione/Description	Price
ADSALT2050	Sterilizzatore Aqua Salt 50mc + pH/Aqua Salt Steriliser 50mc + pH	€ 1.700,00
ADPS200	Pannello dosaggio pH - CL/Dosing panel pH - CL	€ 2.726,20
700800305	Pompa di calore 2,0 HP/Heat pump 2.0 HP	€ 2.816,00
KASP50	Kit Aspirafango/Mud suction kit	€ 200,00
KCIT128	Copertura invernale completa/Complete winter covering	€ 920,00
200300014	Lampada LED multicolor/Multi coloured LED lamp	€ 367,65
200300013	Lampada LED bianca/White LED lamp	€ 220,00



## APPROFONDIMENTI/ DETAILS

<http://aqua.quickris.com/pool-kit-mt-5-00x10-00-sirio-tipo-a2/>



## QR code

Fotografa il codice con lo smartphone e vai direttamente all'approfondimento

Scan the code with your smartphone to obtain more detailed information

## PUBBLICA TIPO A2

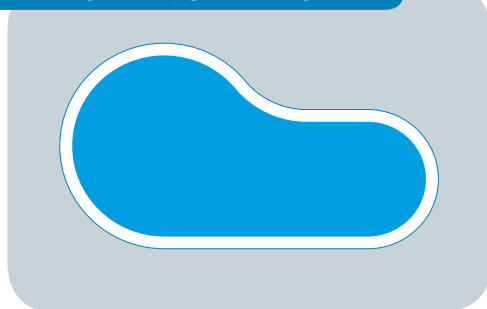

A2



## POOL KIT mt 6.00x12.00 Sirio - Tipo A2

piscine ad uso collettivo, inserite in strutture adibite principalmente ad altre attività ricettive o al servizio della collettività (alberghi, agriturismo, campeggi, palestre, scuole, caserme, etc.)

## POOL KIT 6.00x12.00 m Sirio - Type A2

pools for collective use, installed in facilities mainly offering other hospitality or public services (hotels, farm holiday houses, camping sites, gyms, schools, army barracks, etc.).

Codice Code	Altezza pannelli altezza acqua Panel height - Water height	Perimetro Perimeter	Area Surface	Volume Volume	Rivestimento in rotoli h 1.65 Azzurro Pool lining - rolls h 1.65- Light Blue	Filtrazione mc/h v 35 Filtration cu. m/h v 35	Consumo in kw Consumption in kW	Aqua flex tubo rotoli mt 25 Aqua flex pipe, 25 m rolls	N° skimmer No. of skimmers	Regolatore di livello Level adjuster	N° bocchette No. of nozzles	N° presa di f. No. of main drains	N° fari led bianchi e blue No. of white and blue LED lights	Listino Price List
Skimmer sfioratore/Overflow skimmer														
KAKDA148	125-130	30.50	58.06	75.58	3	15x2	1.1x3	4	3	1	3	2	2	€ 25.805,00
KAKDA149	135-140	30.50	58.06	78.39	3	15x2	1.1x3	4	3	1	3	2	2	€ 26.045,00
Skimmer classic/Skimmer classic														
KAKCA148	120-130	30.50	58.06	69.68	3	15x2	1.1x3	4	3	1	3	2	2	€ 25.955,00
KAKCA149	140-150	30.50	58.06	81.29	3	15x2	1.1x3	4	3	1	3	2	2	€ 26.140,00



## OPTIONAL

Codice/Code	Descrizione/Description	Price
ADSALT2100	Sterilizzatore Aqua Salt 100mc + pH/Aqua Salt Steriliser 100mc + pH	€ 1.840,00
ADPS200	Pannello dosaggio pH - CL/Dosing panel pH - CL	€ 2.726,20
700800305	Pompa di calore 2,0 HP/Heat pump 2.0 HP	€ 2.816,00
KASP50	Kit Aspirafango/Mud suction kit	€ 200,00
KCIT129	Copertura invernale completa/Complete winter covering	€ 1.192,00
200300014	Lampada LED multicolor/Multi coloured LED lamp	€ 367,65
200300013	Lampada LED bianca/White LED lamp	€ 220,00



## APPROFONDIMENTI/ DETAILS

<http://aqua.quickris.com/pool-kit-mt-5-00x10-00-sirio-tipo-a2/>



## QR code

Fotografa il codice con lo smartphone e vai direttamente all'approfondimento

Scan the code with your smartphone to obtain more detailed information

## PUBBLICA TIPO A2

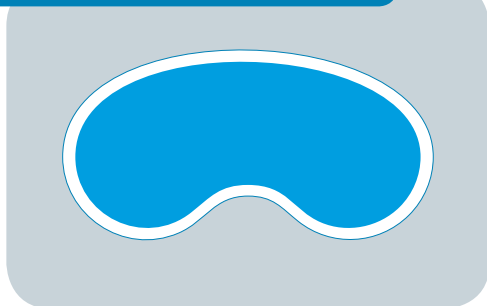

A2



**POOL KIT mt 4.00X8.00 Andromeda - Tipo A2**  
piscine ad uso collettivo, inserite in strutture adibite principalmente ad altre attività ricettive o al servizio della collettività (alberghi, agriturismi, campeggi, palestre, scuole, caserme, etc.)

*POOL KIT 4.00x8.00 m Andromeda - Type A2*  
pools for collective use, installed in facilities mainly offering other hospitality or public services (hotels, farm holiday houses, camping sites, gyms, schools, army barracks, etc.).

Codice Code	Altezza pannelli altezza acqua Panel height - Water height	Perimetro Perimeter	Area Surface	Volume Volume	Rivestimento in rotoli h 1.65 Azzurro Pool lining - rolls h 1.65, Light Blue	Filtrazione mc/h v 35 Filtration cu. m/h v 35	Consumo in kw Consumption in kW	Aqua flex tubo rotoli mt 25 Aqua flex pipe, 25 m rolls	N° skimmer No. of skimmers	Regolatore di livello Level adjuster	N° bocchette No. of nozzles	N° presa di f. No. of main drains	N° fari led bianchi e blue No. of white and blue LED lights	Listino Price List
Skimmer sfioratore/Overflow skimmer														
KAKDA150	125-130	21.00	29.45	36.82	2	9.0x2	0.50x3	4	2	1	2	2	2	€ 19.315,00
KAKDA151	135-140	21.00	29.45	39.76	2	9.0x2	0.50x3	4	2	1	2	2	2	€ 19.510,00
Skimmer classic/Skimmer classic														
KAKCA150	120-130	21.00	29.45	35.34	2	9.0x2	0.50x3	4	2	1	2	2	2	€ 19.380,00
KAKCA151	140-150	21.00	29.45	41.23	2	9.0x2	0.50x3	4	2	1	2	2	2	€ 19.560,00



## OPTIONAL

Codice/Code	Descrizione/Description	Price
ADSALT2050	Sterilizzatore Aqua Salt 50mc + pH/Aqua Salt Steriliser 50mc + pH	€ 1.700,00
ADPS200	Pannello dosaggio pH - CL/Dosing panel pH - CL	€ 2.726,20
700800304	Pompa di calore 1,5 HP/Heat pump 1.5 HP	€ 2.256,00
KASP50	Kit Aspirafango/Mud suction kit	€ 200,00
KCIT130	Copertura invernale completa/Complete winter covering	€ 706,00
200300014	Lampada LED multicolor/Multi coloured LED lamp	€ 367,65
200300013	Lampada LED bianca/White LED lamp	€ 220,00



## APPROFONDIMENTI/ DETAILS

<http://aqua.quickris.com/pool-kit-mt-4-00x-8-00-andromeda-tipo-a2/>



## QR code

Fotografa il codice con lo smartphone e vai direttamente all'approfondimento

Scan the code with your smartphone to obtain more detailed information

## PUBBLICA TIPO A2

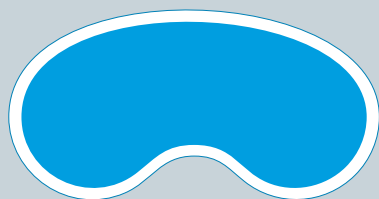

A2



**POOL KIT mt 5.00X10.00 Andromeda - Tipo A2**  
piscine ad uso collettivo, inserite in strutture adibite principalmente ad altre attività ricettive o al servizio della collettività (alberghi, agriturismo, campeggi, palestre, scuole, caserme, etc.)

*POOL KIT 5.00x10.00 m Andromeda - Type A2*  
pools for collective use, installed in facilities mainly offering other hospitality or public services (hotels, farm holiday houses, camping sites, gyms, schools, army barracks, etc.).

Codice Code	Altezza pannelli altezza acqua Panel height - Water height	Perimetro Perimeter	Area Surface	Volume Volume	Rivestimento in rotoli h 1.65 Azzurro Pool lining - rolls h 1.65- Light Blue	Filtrazione mc/h v 35 Filtration cu. m/h v 35	Consumo in kw Consumption in kW	Aqua flex tubo rotoli mt 25 Aqua flex pipe, 25 m rolls	N° skimmer No. of skimmers	Regolatore di livello Level adjuster	N° bocchette No. of nozzles	N° presa di f. No. of main drains	N° fari led bianchi e blue No. of white and blue LED lights	Listino Price List
<i>Skimmer sfioratore/Overflow skimmer</i>														
KAKDA152	125-130	21.00	46.64	58.30	2½	15x2	1.1x3	4	3	1	3	2	2	€ 24.645,00
KAKDA153	135-140	21.00	46.64	62.97	2½	15x2	1.1x3	4	3	1	3	2	2	€ 24.860,00
<i>Skimmer classic/Skimmer classic</i>														
KAKCA152	120-130	21.00	46.64	55.97	2½	15x2	1.1x3	4	3	1	3	2	2	€ 22.350,00
KAKCA153	140-150	21.00	46.64	65.30	2½	15x2	1.1x3	4	3	1	3	2	2	€ 24.985,00



## OPTIONAL

Codice/Code	Descrizione/Description	Price
ADSALT2100	Sterilizzatore Aqua Salt 100mc + pH/Aqua Salt Steriliser 100mc + pH	€ 1.840,00
ADPS200	Pannello dosaggio pH - CL/Dosing panel pH - CL	€ 2.726,20
700800305	Pompa di calore 2,0 HP/Heat pump 2.0 HP	€ 2.816,00
KASP50	Kit Aspirafango/Mud suction kit	€ 200,00
KCIT131	Copertura invernale completa/Complete winter covering	€ 938,00
200300014	Lampada LED multicolor/Multi coloured LED lamp	€ 367,65
200300013	Lampada LED bianca/White LED lamp	€ 220,00



## APPROFONDIMENTI/ DETAILS

<http://aqua.quickris.com/pool-kit-mt-5-00x-10-00-andromeda-tipo-a2/>



## QR code

Fotografa il codice con lo smartphone e vai direttamente all'approfondimento

Scan the code with your smartphone to obtain more detailed information



## PUBBLICA TIPO A2

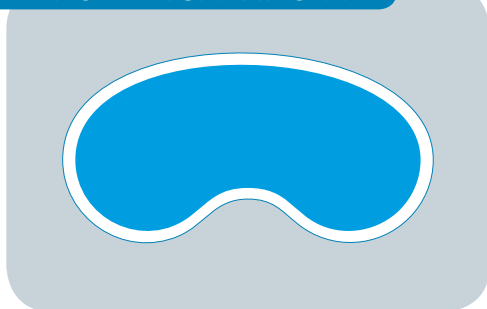

A2



**POOL KIT mt 6.00X12.00 Andromeda - Tipo A2** piscine ad uso collettivo, inserite in strutture adibite principalmente ad altre attività ricettive o al servizio della collettività (alberghi, agriturismi, campeggi, palestre, scuole, caserme, etc.)

*POOL KIT 6.00x12.00 m Andromeda - Type A2* pools for collective use, installed in facilities mainly offering other hospitality or public services (hotels, farm holiday houses, camping sites, gyms, schools, army barracks, etc.).

Codice Code	Altezza pannelli altezza acqua Panel height - Water height	Perimetro Perimeter	Area Surface	Volume Volume	Rivestimento in rotoli h 1.65 Azzurro Pool lining - rolls h 1.65, Light Blue	Filtrazione mc/h v 35 Filtration cu. m/h v 35	Consumo in kw Consumption in kW	Aqua flex tubo rotoli mt 25 Aqua flex pipe, 25 m rolls	N° skimmer No. of skimmers	Regolatore di livello Level adjuster	N° bocchette No. of nozzles	N° presa di f. No. of main drains	N° fari led bianchi e blue No. of white and blue LED lights	Listino Price List
<b>Skimmer sfioratore/Overflow skimmer</b>														
KAKDA154	125-130	31.98	67.68	84.60	3	15x2	1.1x3	5	4	1	4	2	3	€ 27.605,00
KAKDA155	135-140	31.98	67.68	91.37	3	22x2	1.1x3	5	4	1	4	2	3	€ 28.285,00
<b>Skimmer classic/Skimmer classic</b>														
KAKCA154	120-130	31.98	67.68	81.22	3	15x2	1.1x3	5	4	1	4	2	3	€ 27.740,00
KAKCA155	140-150	31.98	67.68	94.76	3	22x2	1.1x3	5	4	1	4	2	3	€ 28.420,00



## OPTIONAL

Codice/Code	Descrizione/Description	Price
ADSALT2100	Sterilizzatore Aqua Salt 100mc + pH/Aqua Salt Steriliser 100mc + pH	€ 1.840,00
ADPS200	Pannello dosaggio pH - CL/Dosing panel pH - CL	€ 2.726,20
700800305	Pompa di calore 2,0 HP/Heat pump 2.0 HP	€ 2.816,00
KASP50	Kit Aspirafango/Mud suction kit	€ 200,00
KCIT132	Copertura invernale completa/Complete winter covering	€ 1.210,00
200300014	Lampada LED multicolor/Multi coloured LED lamp	€ 367,65
200300013	Lampada LED bianca/White LED lamp	€ 220,00



## APPROFONDIMENTI/ DETAILS

<http://aqua.quickris.com/pool-kit-mt-6-00x12-00-andromeda-tipo-a2/>



## QR code

Fotografa il codice con lo smartphone e vai direttamente all'approfondimento

Scan the code with your smartphone to obtain more detailed information

## PUBBLICA TIPO B

B

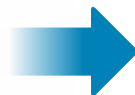

## PUBBLICA - TIPO B - Skimmer

PUBLIC - TYPE B - Skimmer



## CAMPO DI UTILIZZO

Piscine condominiali: destinate esclusivamente agli abitanti del condominio ed ai loro ospiti, con esclusione delle piscine al servizio di edifici abitativi sino a quattro condomini.



## CONTEXT OF USE

Condominium swimming pools: intended only for resident of the apartment building and their guests, except for the pools at the service to residential building up to four condominiums.



## CARATTERISTICHE TECNICHE

## 1) STRUTTURA

Tecnologia a Skimmer H 120cm - 130cm - 140cm - 150cm  
Altezza Aqua > 140cm necessità presenza del bagnino  
Tempi di filtrazione differenti a seconda dell'altezza di Aqua  
(vedi tab. pag 135)

## 2) RIVESTIMENTO

PVC armato

## 3) CIRCOLAZIONE

L'immissione in vasca può avvenire dalle pareti o dal fondo, purché si garantisca l'omogeneizzazione.

I sistemi di ripresa immersi e le prese di fondo devono essere sempre collegate in coppia ad una distanza minima di 2 mt.

## 4) FILTRAZIONE

- Diametro minimo Ø 500mm
- Altezza minima Ø 1000mm
- Altezza minima letto filtrante Ø 600mm
- Velocità di filtrazione  $\delta 40\text{mc/h}$
- Pressione di collaudo deve essere  $\epsilon 1,5$  volte superiore alla pressione massima di esercizio.
- Pressione massima di esercizio con un minimo di 350Kpa.
- Deve essere previsto un numero di filtri  $\geq 1$ ; tutti i filtri devono avere medesime caratteristiche
- Deve essere previsto un numero minimo di pompe, tante quante sono i filtri più 1 di scorta.
- Devono essere previsti minimo 5 punti di lettura.

## 5) ILLUMINAZIONE

- Led

## 6) QUADRO ELETTRICO

- Trifasi



## TECHNICAL FEATURES

## 1) STRUCTURE

Skimmer technology H 120cm - 130cm - 140cm - 150cm  
Water height > 140cm need the presence of the lifeguard  
Filtration time different depending on the water height (see tab. page 135)

## 2) COATING

Reinforced PVC

## 3) CIRCULATION

The return of the water in the pool can be from the wall or from the bottom, provided it is ensure homogenization.

The suction of the swimming pool and the main drain must always be connected in pairs at a minimum distance of 2 meters.

## 4) FILTRATION

- Minimum Diameter Ø 500mm
- Minimum height Ø 1000mm
- Minimum height filtration material Ø 600mm
- Filtration speed  $\delta 40\text{mc/h}$
- Pressure test must be  $\epsilon 1,5$  time higher than the maximum pressure.
- Maximum with a minimum of 350Kpa.
- Must be provided a minimum number of filters  $\geq 1$ ; all the filters must have the same characteristic
- Must be provided a minimum number of pumps, as many filters plus 1 spare.
- Must be provided at least 5 check points.

## 5) LIGHTING

- Led

## 6) ELECTRICAL BOARD

- Three-phase

**NORMATIVE**

Normativa NTC 2008 - L. n°1086 del 05.11.1971: "Norme per la disciplina delle opere in conglomerato cementizio armato, normale e precompresso e in struttura metallica";  
Ordinanza n°3274 del 20.03.2003: "Primi elementi in materia di criteri generali per la classificazione sismica del territorio nazionale e di normative tecniche per la costruzione in zona sismica";  
D.M. del 14.01.2008: "Norme Tecniche per le costruzioni NTC 2008";  
Circolare ministeriale n°617 del 27.02.2009: "Istruzioni per l'applicazione delle Norme Tecniche per le Costruzioni";  
EC3: EUROCODICE 3 EN 1993 1-3; 1-5; 1-2.  
Carichi e movimentazione D. Lgs. 81/08 (ex 626). (MAX KG.30)  
UNI EN 10637:2006  
UNI EN 13451-1:2002 e 13451-3:2002  
UNI EN 13451-1:2002 e 13451-1:2002

**STANDARDS**

NTC 2008 Standard - Italian Law no. 1086 of 05.11.1971: "Regulations for works in reinforced concrete, pre-stressed reinforced concrete and metal structures";  
Italian Order no.3274 of 20.03.2003: "Basic notions on general seismic classification criteria for the national territory and technical rules for construction in seismic areas";  
Italian Ministerial Decree of 14.01.2008: "Technical Standards for Construction NTC 2008";  
Ministerial circular no. 617 of 27.02.2009: "Instructions for the application of Technical Standards for Construction";  
EC3: EUROCODE 3 EN 1993 1-3; 1-5; 1-2.  
Loads and handling - Italian Legislative Decree 81/08 (ex 626). (MAX KG.30)  
UNI EN 10637:2006 - UNI EN 13451-1:2002 and 13451-3:2002  
UNI EN 13451-1:2002 and 13451-1:2002



## PUBBLICA TIPO B

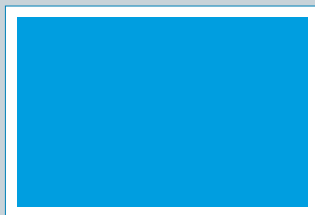

B

## POOL KIT mt 4.00x8.00 - Tipo B

condominali, destinate all'uso esclusivo degli abitanti del condominio e dei loro ospiti, esclusi i condomini fino a 4 unità abitative.



## POOL KIT 4.00x8.00 m - Type B

condominium pools, exclusively used by the inhabitants of a block of flats and their guests, excluding blocks of flats up to 4 apartments.

Codice Code	Altezza pannelli altezza acqua Panel height - Water height	Scala recessa Roman steps	Perimetro Perimeter	Area Surface	Volume Volume	Rivestimento in rotoli h 1.65 Azzurro Pool lining - rolls h.1.65, Light Blue	Rivestimento mq. Azzurro antiscivolo Pool lining sq. m Light Blue, non-slip	Filtrazione mc/h v 40 Filtration cu. m/h v. 40	Consumo in kw Consumption in kW	Aqua flex tubo rotoli mt.25 Aqua flex pipe, 25 m rolls	N° skimmer No. of skimmers	Regolatore di livello Level adjuster	N° bocchette No. of nozzles	N° presa di f. No. of main drains	N° fari led bianchi e blue No. of white and blue LED lights	Listino Price List
Skimmer sfioratore/Overflow skimmer																
KBKDA100	125-130		24.00	32.00	40.00	2		10	0.75x2	4	2	1	2	2	2	€ 16.095,00
KBKDA101	125-130	R 1.5	26.46	36.66	42.91	2½	8.25	17	1.1x2	4	2	1	3	2	2	€ 19.130,00
KBKDA102	125-130	1.6x2.4	27.20	35.84	42.40	2½	8.25	17	1.1x2	4	2	1	3	2	2	€ 19.075,00
KBKDA103	135-140		24.00	32.00	43.20	2		17	1.1x2	4	2	1	2	2	2	€ 16.285,00
KBKDA104	135-140	R 1.5	26.46	36.66	46.34	2½	8.25	17	1.1x2	4	2	1	3	2	2	€ 18.975,00
KBKDA105	135-140	1.6x2.4	27.20	35.84	45.99	2½	8.25	17	1.1x2	4	2	1	3	2	2	€ 19.285,00
Skimmer angolare/Corner skimmer																
KBKAA100	125-130		24.00	32.00	40.00	2		10	0.75x2	4	2	1	2	2	2	€ 15.945,00
KBKAA101	125-130	R 1.5	26.46	36.66	42.91	2½	8.25	17	1.1x2	4	2	1	3	2	2	€ 19.180,00
KBKAA102	125-130	1.6x2.4	27.20	35.84	42.40	2½	8.25	17	1.1x2	4	2	1	3	2	2	€ 19.100,00
KBKAA103	135-140		24.00	32.00	43.20	2		17	1.1x2	4	2	1	2	2	2	€ 15.080,00
KBKAA104	135-140	R 1.5	26.46	36.66	46.34	2½	8.25	17	1.1x2	4	2	1	3	2	2	€ 19.390,00
KBKAA105	135-140	1.6x2.4	27.20	35.84	45.99	2½	8.25	17	1.1x2	4	2	1	3	2	2	€ 19.310,00
Skimmer classic/Skimmer classic																
KBKCA100	120-130		24.00	32.00	38.40	2		10	0.75x2	4	2	1	2	2	2	€ 16.150,00
KBKCA101	120-130	R 1.5	26.46	36.66	43.99	2½	8.25	17	1.1x2	4	2	1	3	2	2	€ 19.215,00
KBKCA102	120-130	1.6x2.4	27.20	35.84	43.01	2½	8.25	17	1.1x2	4	2	1	3	2	2	€ 19.130,00
KBKCA103	140-150		24.00	32.00	44.80	2		17	1.1x2	4	2	1	2	2	2	€ 16.345,00
KBKCA104	140-150	R 1.5	26.46	36.66	50.33	2½	8.25	17	1.1x2	4	2	1	3	2	2	€ 19.375,00
KBKCA105	140-150	1.6x2.4	27.20	35.84	50.18	2½	8.25	17	1.1x2	4	2	1	3	2	2	€ 19.340,00

## + OPTIONAL

Codice/Code	Descrizione/Description	Price
ADSALT2050	Sterilizzatore Aqua Salt 50mc + pH/Aqua Salt Steriliser 50mc + pH	€ 1.700,00
ADPS200	Pannello dosaggio pH - CL/Dosing panel pH - CL	€ 2.726,20
700800304	Pompa di calore 1,5 HP/Heat pump 1.5 HP	€ 2.256,00
KASP50	Kit Aspirafango/Mud suction kit	€ 200,00
KCIT101	Copertura invernale completa/Complete winter covering	€ 580,00
KCIT109	Copertura invernale R 1,5 con scala romana/Winter covering with roman steps R1.5	€ 753,00
KCIT117	Copertura invernale con scala rettangolare 1,6x2,4/Winter covering with rectangular steps 1.6x2.4	€ 720,00
200300014	Lampada LED multicolor/Multi coloured LED lamp	€ 367,65
200300013	Lampada LED bianca/White LED lamp	€ 220,00



## APPROFONDIMENTI/ DETAILS

<http://aqua.quickris.com/pool-kit-mt-4-00x8-00-tipo-b/>



## QR code

Fotografa il codice con lo smartphone e vai direttamente all'approfondimento

Scan the code with your smartphone to obtain more detailed information

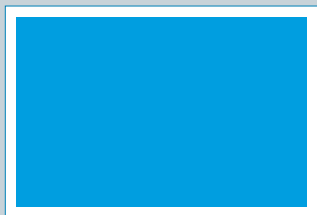

## PUBBLICA TIPO B



## POOL KIT mt 4.80x9.60 - Tipo B

condominali, destinate all'uso esclusivo degli abitanti del condominio e dei loro ospiti, esclusi i condomini fino a 4 unità abitative.



## POOL KIT 4.80x9.60 m - Type B

condominium pools, exclusively used by the inhabitants of a block of flats and their guests, excluding blocks of flats up to 4 apartments.

Codice Code	Altezza pannelli altezza acqua Panel height - Water height	Scala recessa Roman steps	Perimetro Perimeter	Area Surface	Volume Volume	Rivestimento in rotoli h 1.65 Azzurro Pool lining - rolls h.1.65, Light Blue	Rivestimento mq. Azzurro antiscivolo Pool lining sq. m Light Blue, non-slip	Filtrazione mc/h v 40 Filtration cu. m/h v.40	Consumo in kw Consumption in kW	Aqua flex tubo rotoli mt 25 Aqua flex pipe, 25 m rolls	N° skimmer No. of skimmers	Regolatore di livello Level adjuster	N° bocchette No. of nozzles	N° presa di f. No. of main drains	N° fari led bianchi e blue No. of white and blue LED lights	Listino Price List
<b>Skimmer sfioratore/Overflow skimmer</b>																
KBKDA106	125-130		28.80	46.08	57.60	2½		17	1.1x2	4	2	1	2	2	2	€ 18.880,00
KBKDA107	125-130	R 1.5	31.26	50.74	60.51	3	8.25	17	1.1x2	4	2	1	3	2	2	€ 21.315,00
KBKDA108	125-130	1.6x2.4	32.00	49.92	60.00	3	8.25	17	1.1x2	4	2	1	3	2	2	€ 21.005,00
KBKDA109	135-140		28.80	46.08	62.21	2½		17	1.1x2	4	2	1	2	2	2	€ 19.100,00
KBKDA110	135-140	R 1.5	31.26	50.74	65.35	3	8.25	17	1.1x2	4	2	1	3	2	2	€ 21.665,00
KBKDA111	135-140	1.6x2.4	32.00	49.92	64.80	3	8.25	17	1.1x2	4	2	1	3	2	2	€ 21.245,00
<b>Skimmer angolare/Corner skimmer</b>																
KBKAA106	125-130		28.80	46.08	57.60	2½		17	1.1x2	3	2	1	2	2	2	€ 18.735,00
KBKAA107	125-130	R 1.5	31.26	50.74	60.51	3	8.25	17	1.1x2	4	2	1	3	2	2	€ 21.345,00
KBKAA108	125-130	1.6x2.4	32.00	49.92	60.00	3	8.25	17	1.1x2	4	2	1	3	2	2	€ 21.030,00
KBKAA109	135-140		28.80	46.08	62.21	2½		17	1.1x2	3	2	1	2	2	2	€ 18.955,00
KBKAA110	135-140	R 1.5	31.26	50.74	65.35	3	8.25	17	1.1x2	4	2	1	3	2	2	€ 21.880,00
KBKAA111	135-140	1.6x2.4	32.00	49.92	64.80	3	8.25	17	1.1x2	4	2	1	3	2	2	€ 21.270,00
<b>Skimmer classic/Skimmer classic</b>																
KBKCA106	120-130		28.80	46.08	55.30	2½		17	1.1x2	4	2	1	2	2	2	€ 18.940,00
KBKCA107	120-130	R 1.5	31.26	50.74	58.10	3	8.25	17	1.1x2	4	2	1	3	2	2	€ 21.375,00
KBKCA108	120-130	1.6x2.4	32.00	49.92	57.60	3	8.25	17	1.1x2	4	2	1	3	2	2	€ 21.065,00
KBKCA109	140-150		28.80	46.08	64.52	2½		17	1.1x2	4	2	1	2	2	2	€ 19.155,00
KBKCA110	140-150	R 1.5	31.26	50.74	67.78	3	8.25	17	1.1x2	4	2	1	3	2	2	€ 21.700,00
KBKCA111	140-150	1.6x2.4	32.00	49.92	67.20	3	8.25	17	1.1x2	4	2	1	3	2	2	€ 21.290,00

**OPTIONAL**

Codice/Code	Descrizione/Description	Price
ADSALT2100	Sterilizzatore Aqua Salt 100mc + pH/Aqua Salt Steriliser 100mc + pH	€ 1.840,00
ADPS200	Pannello dosaggio pH - CL/Dosing panel pH - CL	€ 2.726,20
700800305	Pompa di calore 2,0 HP/Heat pump 2.0 HP	€ 2.816,00
KASP50	Kit Aspirafango/Mud suction kit	€ 200,00
KCIT102	Copertura invernale completa/Complete winter covering	€ 722,00
KCIT110	Copertura invernale R 1,5 con scala romana/Winter covering with roman steps R1.5	€ 930,00
KCIT118	Copertura invernale con scala rettangolare 1,6x2,4/Winter covering with rectangular steps 1.6x2.4	€ 890,00
200300014	Lampada LED multicolor/Multi coloured LED lamp	€ 367,65
200300013	Lampada LED bianca/White LED lamp	€ 220,00



## APPROFONDIMENTI/ DETAILS

<http://aqua.quickris.com/pool-kit-mt-4-80x9-60-tipo-b/>



## QR code

Fotografa il codice con lo smartphone e vai direttamente all'approfondimento

Scan the code with your smartphone to obtain more detailed information

## PUBBLICA TIPO B

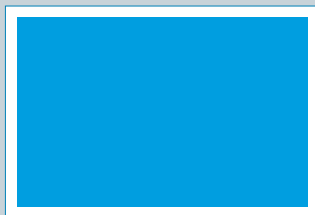

## POOL KIT mt 5.00x10.00 - Tipo B

condominali, destinate all'uso esclusivo degli abitanti del condominio e dei loro ospiti, esclusi i condomini fino a 4 unità abitative.



## POOL KIT 5.00x10.00 m - Type B

condominium pools, exclusively used by the inhabitants of a block of flats and their guests, excluding blocks of flats up to 4 apartments.

Codice Code	Altezza pannelli altezza acqua Panel height - Water height	Scala recessa Roman steps	Perimetro Perimeter	Area Surface	Volume Volume	Rivestimento in rotoli h 165 Azzurro Pool lining - rolls h 165 Light Blue	Rivestimento mq Azzurro antiscivolo Pool lining sq. m Light Blue, non-slip	Filtrazione mc/h v 40 Filtration cu. m/h v 40	Consumo in kw Consumption in kW	Aqua flex tubo rotoli mt 25 Aqua flex pipe, 25 m rolls	N° skimmer No. of skimmers	Regolatore di livello Level adjuster	N° bocchette No. of nozzles	N° presa di f. No. of main drains	N° fari led bianchi e blue No. of white and blue LED lights	Listino Price List
Skimmer sfioratore/Overflow skimmer																
KBKDA112	125-130		30.00	50.00	62.50	3		17	1.1x2	4	3	1	3	2	2	€ 20.175,00
KBKDA113	125-130	R 1.5	32.46	54.66	65.41	3½	8.25	17	1.1x2	4	3	1	4	2	2	€ 22.515,00
KBKDA114	125-130	1.6x2.4	33.20	53.84	64.90	3½	8.25	17	1.1x2	4	3	1	4	2	2	€ 22.435,00
KBKDA115	135-140		30.00	50.00	67.50	3		17	1.1x2	4	3	1	3	2	2	€ 20.410,00
KBKDA116	135-140	R 1.5	32.46	54.66	70.64	3½	8.25	25	1.5x2	4	3	1	4	2	2	€ 23.065,00
KBKDA117	135-140	1.6x2.4	33.20	53.84	70.09	3½	8.25	25	1.5x2	4	3	1	4	2	2	€ 22.985,00
Skimmer angolare/Corner skimmer																
KBKAA112	125-130		30.00	50.00	62.50	3		17	1.1x2	3	3	1	3	2	2	€ 20.030,00
KBKAA113	125-130	R 1.5	32.46	54.66	65.41	3½	8.25	17	1.1x2	4	4	1	4	2	2	€ 22.170,00
KBKAA114	125-130	1.6x2.4	33.20	53.84	64.90	3½	8.25	17	1.1x2	4	4	1	4	2	2	€ 22.090,00
KBKAA115	135-140		30.00	50.00	67.50	3		17	1.1x2	3	3	1	3	2	2	€ 20.265,00
KBKAA116	135-140	R 1.5	32.46	54.66	70.64	3½	8.25	25	1.5x2	4	4	1	4	2	2	€ 23.305,00
KBKAA117	135-140	1.6x2.4	33.20	53.84	70.09	3½	8.25	25	1.5x2	4	4	1	4	2	2	€ 23.225,00
Skimmer classic/Skimmer classic																
KBKCA112	120-130		30.00	50.00	60.00	3		17	1.1x2	4	3	1	3	2	2	€ 20.235,00
KBKCA113	120-130	R 1.5	32.46	54.66	62.80	3½	8.25	17	1.1x2	4	3	1	4	2	2	€ 21.985,00
KBKCA114	120-130	1.6x2.4	33.20	53.84	62.31	3½	8.25	17	1.1x2	4	3	1	4	2	2	€ 21.905,00
KBKCA115	140-150		30.00	50.00	70.00	3		25	1.5x2	4	3	1	3	2	2	€ 20.805,00
KBKCA116	140-150	R 1.5	32.46	54.66	73.26	3½	8.25	25	1.5x2	4	3	1	4	2	2	€ 23.150,00
KBKCA117	140-150	1.6x2.4	33.20	53.84	72.69	3½	8.25	25	1.5x2	4	3	1	4	2	2	€ 23.070,00

**OPTIONAL**

Codice/Code	Descrizione/Description	Price
ADSALT2100	Sterilizzatore Aqua Salt 100mc + pH/Aqua Salt Steriliser 100mc + pH	€ 1.840,00
ADPS200	Pannello dosaggio pH - CL/Dosing panel pH - CL	€ 2.726,20
700800305	Pompa di calore 2,0 HP/Heat pump 2.0 HP	€ 2.816,00
KASP50	Kit Aspirafango/Mud suction kit	€ 200,00
KCIT103	Copertura invernale completa/Complete winter covering	€ 757,00
KCIT111	Copertura invernale R 1,5 con scala romana/Winter covering with roman steps R 1.5	€ 980,00
KCIT119	Copertura invernale con scala rettangolare 1,6x2,4/Winter covering with rectangular steps 1.6x2.4	€ 930,00
200300014	Lampada LED multicolor/Multi coloured LED lamp	€ 367,65
200300013	Lampada LED bianca/White LED lamp	€ 220,00



## APPROFONDIMENTI/ DETAILS

<http://aqua.quickris.com/pool-kit-mt-5-00x10-00-tipo-b/>



## QR code

Fotografa il codice con lo smartphone e vai direttamente all'approfondimento

Scan the code with your smartphone to obtain more detailed information

## PUBBLICA TIPO B

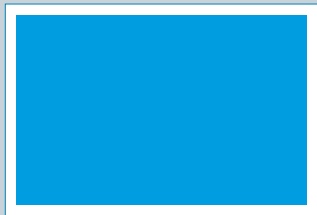

## POOL KIT mt 5.60x11.20 - Tipo B

condominali, destinate all'uso esclusivo degli abitanti del condominio e dei loro ospiti, esclusi i condomini fino a 4 unità abitative.



## POOL KIT 5.60x11.20 m - Type B

condominium pools, exclusively used by the inhabitants of a block of flats and their guests, excluding blocks of flats up to 4 apartments.

Code Codice	Altezza pannelli altezza acqua Panel height - Water height	Scala recessa Roman steps	Perimetro Perimeter	Area Surface	Volume Volume	Rivestimento in rotoli h 165 Azzurro Pool lining - rolls h 165 Light Blue	Rivestimento mq Azzurro antiscivolo Pool lining sq. m Light Blue, non-slip	Filtrazione mc/h v 40 Filtration cu. m/h v 40	Consumo in kw Consumption in kW	Aqua flex tubo rotoli mt 25 Aqua flex pipe, 25 m rolls	N° skimmer No. of skimmers	Regolatore di livello Level adjuster	N° bocchette No. of nozzles	N° presa di f. No. of main drains	N° fari led bianchi e blue No. of white and blue LED lights	Listino Price List
Skimmer sfioratore/Overflow skimmer																
KBKDA118	125-130		33.60	62.72	78.40	3½		25	1.5x2	4	3	1	3	2	3	€ 22.425,00
KBKDA119	125-130	R 1.5	36.06	67.38	81.31	4	8.25	25	1.5x2	5	3	1	4	2	3	€ 24.765,00
KBKDA120	125-130	1.6x2.4	36.80	66.56	80.80	4	8.25	25	1.5x2	5	3	1	4	2	3	€ 24.655,00
KBKDA121	135-140		33.60	62.72	84.67	3½		25	1.5x2	4	3	1	3	2	3	€ 22.675,00
KBKDA122	135-140	R 1.5	36.06	67.38	87.82	4	8.25	25	1.5x2	5	3	1	4	2	3	€ 25.030,00
KBKDA123	135-140	1.6x2.4	36.80	66.56	87.26	4	8.25	25	1.5x2	5	3	1	4	2	3	€ 24.925,00
Skimmer angolare/Corner skimmer																
KBKAA118	125-130		33.60	62.72	78.40	3½		25	1.5x2	4	3	1	3	2	3	€ 22.435,00
KBKAA119	125-130	R 1.5	36.06	67.38	81.31	4	8.25	25	1.5x2	5	3	1	4	2	3	€ 24.760,00
KBKAA120	125-130	1.6x2.4	36.80	66.56	80.80	4	8.25	25	1.5x2	5	3	1	4	2	3	€ 24.650,00
KBKAA121	135-140		33.60	62.72	84.67	3½		25	1.5x2	4	3	1	3	2	3	€ 22.680,00
KBKAA122	135-140	R 1.5	36.06	67.38	87.82	4	8.25	25	1.5x2	5	3	1	4	2	3	€ 25.025,00
KBKAA123	135-140	1.6x2.4	36.80	66.56	87.26	4	8.25	25	1.5x2	5	3	1	4	2	3	€ 24.415,00
Skimmer classic/Skimmer classic																
KBKCA118	120-130		33.60	62.72	75.27	3½		25	1.5x2	4	3	1	3	2	3	€ 22.515,00
KBKCA119	120-130	R 1.5	36.06	67.38	80.86	4	8.25	25	1.5x2	5	3	1	4	2	3	€ 24.855,00
KBKCA120	120-130	1.6x2.4	36.80	66.56	79.88	4	8.25	25	1.5x2	5	3	1	4	2	3	€ 24.750,00
KBKCA121	140-150		33.60	62.72	87.81	3½		25	1.5x2	4	3	1	3	2	3	€ 22.760,00
KBKCA122	140-150	R 1.5	36.06	67.38	91.07	4	8.25	25	1.5x2	5	3	1	4	2	3	€ 25.075,00
KBKCA123	140-150	1.6x2.4	36.80	66.56	90.50	4	8.25	25	1.5x2	5	3	1	4	2	3	€ 25.015,00

**OPTIONAL**

Codice/Code	Descrizione/Description	Price
ADSALT2100	Sterilizzatore Aqua Salt 100mc + pH/Aqua Salt Steriliser 100mc + pH	€ 1.840,00
ADPS200	Pannello dosaggio pH - CL/Dosing panel pH - CL	€ 2.726,20
700800306	Pompa di calore 2,5 HP/Heat pump 2.5 HP	€ 3.639,00
KASP50	Kit Aspirafango/Mud suction kit	€ 200,00
KCIT104	Copertura invernale completa/Complete winter covering	€ 878,00
KCIT112	Copertura invernale R 1,5 con scala romana/Winter covering with roman steps R 1.5	€ 1.123,00
KCIT120	Copertura invernale con scala rettangolare 1,6x2,4/Winter covering with rectangular steps 1.6x2.4	€ 1.075,00
200300014	Lampada LED multicolor/Multi coloured LED lamp	€ 367,65
200300013	Lampada LED bianca/White LED lamp	€ 220,00



## APPROFONDIMENTI/ DETAILS

<http://aqua.quickris.com/pool-kit-mt-5-60x11-20-tipo-b/>



## QR code

Fotografa il codice con lo smartphone e vai direttamente all'approfondimento

Scan the code with your smartphone to obtain more detailed information

## PUBBLICA TIPO B

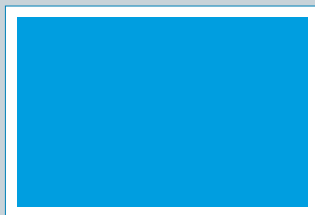

## POOL KIT mt 6.00x12.00 - Tipo B

condominali, destinate all'uso esclusivo degli abitanti del condominio e dei loro ospiti, esclusi i condomini fino a 4 unità abitative.



## POOL KIT 6.00x12.00 m - Type B

condominium pools, exclusively used by the inhabitants of a block of flats and their guests, excluding blocks of flats up to 4 apartments.

Codice Code	Altezza pannelli altezza acqua Panel height - Water height	Scala recessa Roman steps	Perimetro Perimeter	Area Surface	Volume Volume	Rivestimento in rotoli h 165 Azzurro Pool lining - rolls h.165 Light Blue	Rivestimento mq -Azzurro antiscivolo Pool lining sq. m Light Blue, non-slip	Filtrazione mc/h v 40 Filtration cu. m/h v 40	Consumo in kw Consumption in kW	Aqua flex tubo rotoli mt 25 Aqua flex pipe, 25 m rolls	N° skimmer No. of skimmers	Regolatore di livello Level adjuster	N° bocchette No. of nozzles	N° presa di f. No. of main drains	N° fari led bianchi e blue No. of white and blue LED lights	Listino Price List
<b>Skimmer sfioratore/Overflow skimmer</b>																
KBKDA124	125-130		36.00	72.00	90.00	4		25	1.5x2	4	3	1	3	2	3	€ 23.875,00
KBKDA125	125-130	R 1.5	38.46	76.66	92.91	4	8.25	25	1.5x2	5	4	1	4	2	3	€ 26.075,00
KBKDA126	125-130	1.6x2.4	39.20	75.84	92.40	4	8.25	25	1.5x2	5	4	1	4	2	3	€ 25.880,00
KBKDA127	135-140		36.00	72.00	97.20	4		25	1.5x2	4	3	1	3	2	3	€ 24.145,00
KBKDA128	135-140	R 1.5	38.46	76.66	100.35	4	8.25	25	1.5x2	5	4	1	4	2	3	€ 26.365,00
KBKDA129	135-140	1.6x2.4	39.20	75.84	99.80	4	8.25	25	1.5x2	5	4	1	4	2	3	€ 26.170,00
<b>Skimmer angolare/Corner skimmer</b>																
KBKAA124	125-130		36.00	72.00	90.00	4		25	1.5x2	5	3	1	3	2	3	€ 24.085,00
KBKAA125	125-130	R 1.5	38.46	76.66	92.91	4	8.25	25	1.5x2	5	4	1	4	2	3	€ 25.960,00
KBKAA126	125-130	1.6x2.4	39.20	75.84	92.40	4	8.25	25	1.5x2	5	4	1	4	2	3	€ 25.765,00
KBKAA127	135-140		36.00	72.00	97.20	4		25	1.5x2	5	3	1	3	2	3	€ 24.355,00
KBKAA128	135-140	R 1.5	38.46	76.66	100.35	4	8.25	25	1.5x2	5	4	1	4	2	3	€ 26.250,00
KBKAA129	135-140	1.6x2.4	39.20	75.84	99.80	4	8.25	25	1.5x2	5	4	1	4	2	3	€ 26.055,00
<b>Skimmer classic/Skimmer classic</b>																
KBKCA124	120-130		36.00	72.00	86.40	4		25	1.5x2	4	3	1	3	2	3	€ 23.965,00
KBKCA125	120-130	R 1.5	38.46	76.66	89.20	4	8.25	25	1.5x2	5	4	1	4	2	3	€ 26.195,00
KBKCA126	120-130	1.6x2.4	39.20	75.84	88.71	4	8.25	25	1.5x2	5	4	1	4	2	3	€ 26.000,00
KBKCA127	140-150		36.00	72.00	100.80	4		25	1.5x2	4	3	1	3	2	3	€ 24.235,00
KBKCA128	140-150	R 1.5	38.46	76.66	107.33	4	8.25	34	1.1x3	5	4	1	4	2	3	€ 31.020,00
KBKCA129	140-150	1.6x2.4	39.20	75.84	103.49	4	8.25	34	1.1x3	5	4	1	4	2	3	€ 30.850,00

**OPTIONAL**

Codice/Code	Descrizione/Description	Price
ADSALT2100	Sterilizzatore Aqua Salt 100mc + pH/Aqua Salt Steriliser 100mc + pH	€ 1.840,00
ADPS200	Pannello dosaggio pH - CL/Dosing panel pH - CL	€ 2.726,20
700800306	Pompa di calore 2,5 HP/Heat pump 2.5 HP	€ 3.639,00
KASP50	Kit Aspirafango/Mud suction kit	€ 200,00
KCIT105	Copertura invernale completa/Complete winter covering	€ 960,00
KCIT113	Copertura invernale R 1,5 con scala romana/Winter covering with roman steps R1.5	€ 1.230,00
KCIT121	Copertura invernale con scala rettangolare 1,6x2,4/Winter covering with rectangular steps 1.6x2.4	€ 1.166,00
200300014	Lampada LED multicolor/Multi coloured LED lamp	€ 367,65
200300013	Lampada LED bianca/White LED lamp	€ 220,00

**APPROFONDIMENTI/ DETAILS**

<http://aqua.quickris.com/pool-kit-mt-6-00x12-00-tipo-b/>



**QR code**

Fotografa il codice con lo smartphone e vai direttamente all'approfondimento

Scan the code with your smartphone to obtain more detailed information

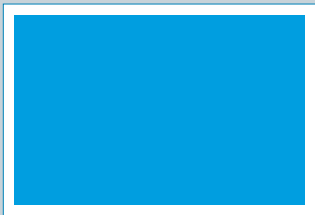

## PUBBLICA TIPO B



## POOL KIT mt 6.40x12.80 - Tipo B

condominali, destinate all'uso esclusivo degli abitanti del condominio e dei loro ospiti, esclusi i condomini fino a 4 unità abitative.



## POOL KIT 6.40x12.80 m - Type B

condominium pools, exclusively used by the inhabitants of a block of flats and their guests, excluding blocks of flats up to 4 apartments.

Code Code	Altezza pannelli altezza acqua Panel height - Water height	Scala recessa Roman steps	Perimetro Perimeter	Area Surface	Volume Volume	Rivestimento in rotoli h 165 Azzurro Pool lining - rolls h 165 Light Blue	Rivestimento mq Azzurro antiscivolo Pool lining sq. m Light Blue, non-slip	Filtrazione mc/h v 40 Filtration cu. m/h v 40	Consumo in kw Consumption in kW	Aqua flex tubo rotoli mt 25 Aqua flex pipe, 25 m rolls	N° skimmer No. of skimmers	Regolatore di livello Level adjuster	N° bocchette No. of nozzles	N° presa di f. No. of main drains	N° fari led bianchi e blue No. of white and blue LED lights	Listino Price List
Skimmer sfioratore/Overflow skimmer																
KBKDA130	125-130		38.40	81.92	102.40	4½		34	1.1x3	5	4	1	4	2	4	€ 30.340,00
KBKDA131	125-130	R 1.5	40.86	86.58	105.32	5	8.25	34	1.1x3	5	4	1	5	2	4	€ 32.800,00
KBKDA132	125-130	1.6x2.4	41.60	85.76	104.80	5	8.25	34	1.1x3	5	4	1	5	2	4	€ 32.565,00
KBKDA133	135-140		38.40	81.92	110.60	4½		34	1.1x3	5	4	1	4	2	4	€ 30.615,00
KBKDA134	135-140	R 1.5	40.86	86.58	113.74	5	8.25	34	1.1x3	5	4	1	5	2	4	€ 33.100,00
KBKDA135	135-140	1.6x2.4	41.60	85.76	113.18	5	8.25	34	1.1x3	5	4	1	5	2	4	€ 32.860,00
Skimmer angolare/Corner skimmer																
KBKAA130	125-130		38.40	81.92	102.40	4½		34	1.1x3	4	4	1	4	2	4	€ 25.670,00
KBKAA131	125-130	R 1.5	40.86	86.58	105.32	5	8.25	34	1.1x3	5	4	1	5	2	4	€ 32.845,00
KBKAA132	125-130	1.6x2.4	41.60	85.76	104.80	5	8.25	34	1.1x3	5	4	1	5	2	4	€ 32.600,00
KBKAA133	135-140		38.40	81.92	110.60	4½		34	1.1x3	4	4	1	4	2	4	€ 30.500,00
KBKAA134	135-140	R 1.5	40.86	86.58	113.74	5	8.25	34	1.1x3	5	4	1	5	2	4	€ 33.135,00
KBKAA135	135-140	1.6x2.4	41.60	85.76	113.18	5	8.25	34	1.1x3	5	4	1	5	2	4	€ 32.890,00
Skimmer classic/Skimmer classic																
KBKCA130	120-130		38.40	81.92	98.31	4½		25	1.5x2	5	4	1	4	2	4	€ 25.905,00
KBKCA131	120-130	R 1.5	40.86	86.58	101.10	5	8.25	25	1.5x2	5	4	1	5	2	4	€ 32.895,00
KBKCA132	120-130	1.6x2.4	41.60	85.76	100.61	5	8.25	25	1.5x2	5	4	1	5	2	4	€ 32.655,00
KBKCA133	140-150		38.40	81.92	114.69	4½		34	1.1x3	5	4	1	4	2	4	€ 30.730,00
KBKCA134	140-150	R 1.5	40.86	86.58	117.95	5	8.25	34	1.1x3	5	4	1	5	2	4	€ 33.145,00
KBKCA135	140-150	1.6x2.4	41.60	85.76	117.38	5	8.25	34	1.1x3	5	4	1	5	2	4	€ 32.950,00

**OPTIONAL**

Codice/Code	Descrizione/Description	Price
ADSALT2150	Sterilizzatore Aqua Salt 150mc + pH/Aqua Salt Steriliser 150mc + pH	€ 2.190,00
ADPS201	Pannello dosaggio pH - CL/Dosing panel pH - CL	€ 2.726,20
700800307	Pompa di calore 3,0 HP/Heat pump 3.0 HP	€ 4.144,00
KASP50	Kit Aspirafango/Mud suction kit	€ 200,00
KCIT106	Copertura invernale completa/Complete winter covering	€ 1.054,00
KCIT114	Copertura invernale R 1,5 con scala romana/Winter covering with roman steps R1.5	€ 1.338,00
KCIT122	Copertura invernale con scala rettangolare 1,6x2,4/Winter covering with rectangular steps 1.6x2.4	€ 1.282,00
200300014	Lampada LED multicolor/Multi coloured LED lamp	€ 367,65
200300013	Lampada LED bianca/White LED lamp	€ 220,00



## APPROFONDIMENTI/ DETAILS

<http://aqua.quickris.com/pool-kit-mt-6-40x12-80-tipo-b/>



## QR code

Fotografa il codice con lo smartphone e vai direttamente all'approfondimento

Scan the code with your smartphone to obtain more detailed information

## PUBBLICA TIPO B

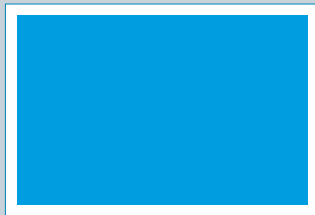

## POOL KIT mt 7.00x14.00 - Tipo B

condominiali, destinate all'uso esclusivo degli abitanti del condominio e dei loro ospiti, esclusi i condomini fino a 4 unità abitative.



## POOL KIT 7.00x14.00 m - Type B

condominium pools, exclusively used by the inhabitants of a block of flats and their guests, excluding blocks of flats up to 4 apartments.

Codice Code	Altezza pannelli altezza acqua Panel height - Water height	Perimetro Perimeter	Area Surface	Volume Volume	Rivestimento in rotoli h 1.65 Azzurro Pool lining - rolls h 1.65: Light Blue	Filtrazione mc/h v 40 Filtration cu. m/h v 40	Consumo in kw Consumption in kW	Aqua flex tubo rotoli mt 25 Aqua flex pipe, 25 m rolls	N° skimmer No. of skimmers	Regolatore di livello Level adjuster	N° bocchette No. of nozzles	N° presa di f. No. of main drains	N° fari led bianchi e blue No. of white and blue LED lights	Listino Price List
Skimmer sfioratore/Overflow skimmer														
KBKDA136	125-130	42.00	98.00	122.50	4½	34	1.1x3	5	4	1	4	2	4	€ 32.240,00
KBKDA137	135-140	42.00	98.00	132.30	4½	34	1.1x3	5	4	1	4	2	4	€ 32.535,00
Skimmer angolare/Corner skimmer														
KBKAA136	125-130	42.00	98.00	114.65	4½	34	1.1x3	4	4	1	4	2	4	€ 32.140,00
KBKAA137	135-140	42.00	98.00	134.25	4½	34	1.1x3	4	4	1	4	2	4	€ 32.440,00
Skimmer classic/Skimmer classic														
KBKCA136	120-130	42.00	98.00	117.60	4½	34	1.1x3	5	4	1	4	2	4	€ 32.355,00
KBKCA137	140-150	42.00	98.00	137.20	4½	34	1.1x3	5	4	1	4	2	4	€ 32.655,00



## OPTIONAL

Codice/Code	Descrizione/Description	Price
ADSALT2150	Sterilizzatore Aqua Salt 150mc + pH/Aqua Salt Steriliser 150mc + pH	€ 2.190,00
ADPS201	Pannello dosaggio pH - CL/Dosing panel pH - CL	€ 2.774,94
700800307	Pompa di calore 3,0 HP/Heat pump 3.0 HP	€ 4.144,00
KASP50	Kit Aspirafango/Mud suction kit	€ 200,00
KCIT107	Copertura invernale completa/Complete winter covering	€ 1.185,00
KCIT115	Copertura invernale R 1,5 con scala romana/Winter covering with roman steps R1.5	€ 1.510,00
KCIT123	Copertura invernale con scala rettangolare 1,6x2,4/Winter covering with rectangular steps 1.6x2.4	€ 1.437,00
200300014	Lampada LED multicolor/Multi coloured LED lamp	€ 367,65
200300013	Lampada LED bianca/White LED lamp	€ 220,00



## APPROFONDIMENTI/ DETAILS

<http://aqua.quickcris.com/pool-kit-mt-7-00x14-00-tipo-b/>



## QR code

Fotografa il codice con lo smartphone e vai direttamente all'approfondimento

Scan the code with your smartphone to obtain more detailed information

## PUBBLICA TIPO B

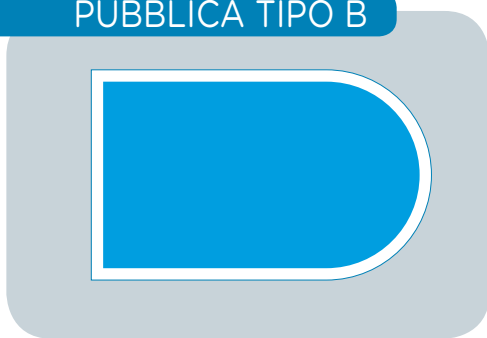

## POOL KIT mt 4.00X8.00 Orione - Tipo B

condominiali, destinate all'uso esclusivo degli abitanti del condominio e dei loro ospiti, esclusi i condomini fino a 4 unità abitative.

## POOL KIT 4.00x8.00 m Orione - Type B

condominium pools, exclusively used by the inhabitants of a block of flats and their guests, excluding blocks of flats up to 4 apartments.

Codice Code	Altezza pannelli altezza acqua Panel height - Water height	Perimetro Perimeter	Area Surface	Volume Volume	Rivestimento in rotoli h 1.65 Azzurro Pool lining - rolls h.1.65, Light Blue	Filtrazione mc/h v 40 Filtration cu. m/h v 40	Consumo in kw Consumption in kW	Aqua flex tubo rotoli mt 25 Aqua flex pipe, 25 m rolls	N° skimmer No. of skimmers	Regolatore di livello Level adjuster	N° bocchette No. of nozzles	N° presa di f. No. of main drains	N° fari led bianchi e blue No. of white and blue LED lights	Listino Price List
Skimmer sfioratore/Overflow skimmer														
KBKDA138	125-130	22.28	30.28	37.85	10	10	0.75x2	4	2	1	2	2	2	€ 15.875,00
KBKDA139	135-140	22.28	30.28	40.88	10	17	1.1x2	4	2	1	2	2	2	€ 16.970,00
Skimmer classic/Skimmer classic														
KBKCA138	120-130	22.28	30.28	36.34	10	10	0.75x2	4	2	1	2	2	2	€ 15.935,00
KBKCA139	140-150	22.28	30.28	42.40	10	17	1.1x2	4	2	1	2	2	2	€ 17.030,00



## OPTIONAL

Codice/Code	Descrizione/Description	Price
ADSALT2050	Sterilizzatore Aqua Salt 50mc + pH/Aqua Salt Steriliser 50mc + pH	€ 1.700,00
ADPS200	Pannello dosaggio pH - CL/Dosing panel pH - CL	€ 2.726,20
700800304	Pompa di calore 1,5 HP/Heat pump 1.5 HP	€ 2.256,00
KASP50	Kit Aspirafango/Mud suction kit	€ 200,00
KCIT124	Copertura invernale completa/Complete winter covering	€ 706,00
200300014	Lampada LED multicolor/Multi coloured LED lamp	€ 367,65
200300013	Lampada LED bianca/White LED lamp	€ 220,00



## APPROFONDIMENTI/ DETAILS

<http://aqua.quickris.com/pool-kit-mt-4-00x8-00-orione-tipo-b/>



## QR code

Fotografa il codice con lo smartphone e vai direttamente all'approfondimento

Scan the code with your smartphone to obtain more detailed information

## PUBBLICA TIPO B



## POOL KIT mt 5.00X10.00 Orione - Tipo B

condominiali, destinate all'uso esclusivo degli abitanti del condominio e dei loro ospiti, esclusi i condomini fino a 4 unità abitative.



## POOL KIT 5.00x10.00 m Orione - Type B

condominium pools, exclusively used by the inhabitants of a block of flats and their guests, excluding blocks of flats up to 4 apartments.

Codice Code	Altezza pannelli altezza acqua Panel height - Water height	Perimetro Perimeter	Area Surface	Volume Volume	Rivestimento in rotoli h 1.65 Azzurro Pool lining - rolls h 1.65: Light Blue	Filtrazione mc/h v 40 Filtration cu. m/h v 40	Consumo in kw Consumption in kW	Aqua flex tubo rotoli mt 25 Aqua flex pipe, 25 m rolls	N° skimmer No. of skimmers	Regolatore di livello Level adjuster	N° bocchette No. of nozzles	N° presa di f. No. of main drains	N° fari led bianchi e blue No. of white and blue LED lights	Listino Price List
Skimmer sfioratore/Overflow skimmer														
KBKDA140	125-130	27.85	47.32	59.15	2½	17	1.1x2	4	2	1	2	2	2	€ 19.320,00
KBKDA141	135-140	27.85	47.32	63.89	2½	17	1.1x2	4	2	1	2	2	2	€ 19.615,00
Skimmer classic/Skimmer classic														
KBKCA140	120-130	27.85	47.32	56.79	2½	17	1.1x2	4	2	1	2	2	2	€ 19.375,00
KBKCA141	140-150	27.85	47.32	66.25	2½	17	1.1x2	4	2	1	2	2	2	€ 19.675,00



## OPTIONAL

Codice/Code	Descrizione/Description	Price
ADSALT2100	Sterilizzatore Aqua Salt 100mc + pH/Aqua Salt Steriliser 100mc + pH	€ 1.840,00
ADPS200	Pannello dosaggio pH - CL/Dosing panel pH - CL	€ 2.726,20
700800305	Pompa di calore 2,0 HP/Heat pump 2.0 HP	€ 2.816,00
KASP50	Kit Aspirafango/Mud suction kit	€ 200,00
KCIT125	Copertura invernale completa/Complete winter covering	€ 946,00
200300014	Lampada LED multicolor/Multi coloured LED lamp	€ 367,65
200300013	Lampada LED bianca/White LED lamp	€ 220,00



## APPROFONDIMENTI/ DETAILS

<http://aqua.quickris.com/pool-kit-mt-5-00x10-00-orione-tipo-b/>



## QR code

Fotografa il codice con lo smartphone e vai direttamente all'approfondimento

Scan the code with your smartphone to obtain more detailed information



## PUBBLICA TIPO B



## POOL KIT mt 6.00X12.00 Orione - Tipo B

condominiali, destinate all'uso esclusivo degli abitanti del condominio e dei loro ospiti, esclusi i condomini fino a 4 unità abitative.



## POOL KIT 6.00x12.00 m Orione - Type B

condominium pools, exclusively used by the inhabitants of a block of flats and their guests, excluding blocks of flats up to 4 apartments.

Codice Code	Altezza pannelli altezza acqua Panel height - Water height	Perimetro Perimeter	Area Surface	Volume Volume	Rivestimento in rotoli h 1.65 Azzurro Pool lining - rolls h 1.65, Light Blue	Filtrazione mc/h v 40 Filtration cu. m/h v 40	Consumo in kw Consumption in kW	Aqua flex tubo rotoli mt 25 Aqua flex pipe, 25 m rolls	N° skimmer No. of skimmers	Regolatore di livello Level adjuster	N° bocchette No. of nozzles	N° presa di f. No. of main drains	N° fari led bianchi e blue No. of white and blue LED lights	Listino Price List
Skimmer sfioratore/Overflow skimmer														
KBKDA142	125-130	33.42	68.14	85.18	3½	25	1.5x2	4	3	1	3	2	3	€ 22.845,00
KBKDA143	135-140	33.42	68.14	91.99	3½	25	1.5x2	4	3	1	3	2	3	€ 23.095,00
Skimmer classic/Skimmer classic														
KBKCA142	120-130	33.42	68.14	81.77	3½	25	1.5x2	4	3	1	3	2	3	€ 22.935,00
KBKCA143	140-150	33.42	68.14	95.40	3½	25	1.5x2	4	3	1	3	2	3	€ 23.185,00



## OPTIONAL

Codice/Code	Descrizione/Description	Price
ADSALT2100	Sterilizzatore Aqua Salt 100mc + pH/Aqua Salt Steriliser 100mc + pH	€ 1.840,00
ADPS200	Pannello dosaggio pH - CL/Dosing panel pH - CL	€ 2.726,20
700800305	Pompa di calore 2,0 HP/Heat pump 2.0 HP	€ 2.816,00
KASP50	Kit Aspirafango/Mud suction kit	€ 200,00
KCIT126	Copertura invernale completa/Complete winter covering	€ 1.222,00
200300014	Lampada LED multicolor/Multi coloured LED lamp	€ 367,65
200300013	Lampada LED bianca/White LED lamp	€ 220,00



## APPROFONDIMENTI/ DETAILS

<http://aqua.quickris.com/pool-kit-mt-6-00x12-00-orione-tipo-b/>



## QR code

Fotografa il codice con lo smartphone e vai direttamente all'approfondimento

Scan the code with your smartphone to obtain more detailed information

## PUBBLICA TIPO B

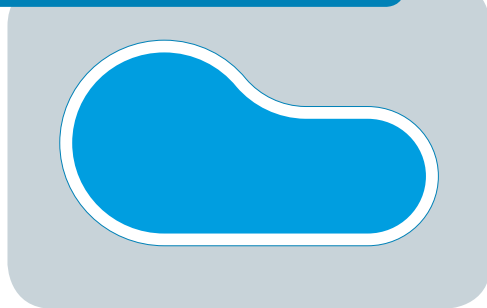

## POOL KIT mt 4.00X8.00 Sirio - Tipo B

condominiali, destinate all'uso esclusivo degli abitanti del condominio e dei loro ospiti, esclusi i condomini fino a 4 unità abitative.



## POOL KIT 4.00x8.00 m Sirio - Type B

condominium pools, exclusively used by the inhabitants of a block of flats and their guests, excluding blocks of flats up to 4 apartments.

Codice Code	Altezza pannelli altezza acqua Panel height - Water height	Perimetro Perimeter	Area Surface	Volume Volume	Rivestimento in rotoli h 1.65 Azzurro Pool lining - rolls h 1.65: Light Blue	Filtrazione mc/h v 40 Filtration cu. m/h v 40	Consumo in kw Consumption in kW	Aqua flex tubo rotoli mt 25 Aqua flex pipe, 25 m rolls	N° skimmer No. of skimmers	Regolatore di livello Level adjuster	N° bocchette No. of nozzles	N° presa di f. No. of main drains	N° fari led bianchi e blue No. of white and blue LED lights	Listino Price List
Skimmer sfioratore/Overflow skimmer														
KBKDA144	125-130	20.24	24.64	30.80	2	10	0.75x2	4	2	1	2	2	2	€ 15.395,00
KBKDA145	135-140	20.24	24.64	33.27	2	10	0.75x2	4	2	1	2	2	2	€ 15.725,00
Skimmer classic/Skimmer classic														
KBKCA144	120-130	20.24	24.64	29.57	2	10	0.75x2	4	2	1	2	2	2	€ 15.455,00
KBKCA145	140-150	20.24	24.64	34.50	2	10	0.75x2	4	2	1	2	2	2	€ 15.785,00



## OPTIONAL

Codice/Code	Descrizione/Description	Price
ADSALT2050	Sterilizzatore Aqua Salt 50mc + pH/Aqua Salt Steriliser 50mc + pH	€ 1.700,00
ADPS200	Pannello dosaggio pH - CL/Dosing panel pH - CL	€ 2.726,20
700800304	Pompa di calore 1,5 HP/Heat pump 1.5 HP	€ 2.256,00
KASP50	Kit Aspirafango/Mud suction kit	€ 200,00
KCIT127	Copertura invernale completa/Complete winter covering	€ 688,00
200300014	Lampada LED multicolor/Multi coloured LED lamp	€ 367,65
200300013	Lampada LED bianca/White LED lamp	€ 220,00



## APPROFONDIMENTI/ DETAILS

<http://aqua.quickris.com/pool-kit-mt-4-00x8-00-sirio-tipo-b/>



## QR code

Fotografa il codice con lo smartphone e vai direttamente all'approfondimento

Scan the code with your smartphone to obtain more detailed information

## PUBBLICA TIPO B

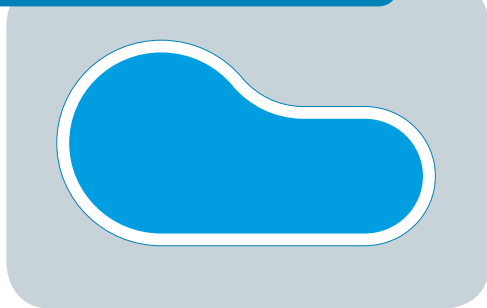

## POOL KIT mt 5.00X10.00 Sirio - Tipo B

condominali, destinate all'uso esclusivo degli abitanti del condominio e dei loro ospiti, esclusi i condomini fino a 4 unità abitative.



## POOL KIT 5.00x10.00 m Sirio - Type B

condominium pools, exclusively used by the inhabitants of a block of flats and their guests, excluding blocks of flats up to 4 apartments.

Codice Code	Altezza pannelli altezza acqua Panel height - Water height	Perimetro Perimeter	Area Surface	Volume Volume	Rivestimento in rotoli h 1.65 Azzurro Pool lining - rolls h.1.65, Light Blue	Filtrazione mc/h v 40 Filtration cu. m/h v 40	Consumo in kw Consumption in kW	Aqua flex tubo rotoli mt 25 Aqua flex pipe, 25 m rolls	N° skimmer No. of skimmers	Regolatore di livello Level adjuster	N° bocchette No. of nozzles	N° presa di f. No. of main drains	N° fari led bianchi e blue No. of white and blue LED lights	Listino Price List
Skimmer sfioratore/Overflow skimmer														
KBKDA146	125-130	25.37	39.56	49.45	2½	17	1.1x2	4	2	1	2	2	2	€ 18.550,00
KBKDA147	135-140	25.37	39.56	53.41	2½	17	1.1x2	4	2	1	2	2	2	€ 18.755,00
Skimmer classic/Skimmer classic														
KBKCA146	120-130	25.37	39.56	47.48	2½	17	1.1x2	4	2	1	2	2	2	€ 18.430,00
KBKCA147	140-150	25.37	39.56	55.39	2½	17	1.1x2	4	2	1	2	2	2	€ 18.815,00



## OPTIONAL

Codice/Code	Descrizione/Description	Price
ADSALT2100	Sterilizzatore Aqua Salt 100mc + pH/Aqua Salt Steriliser 100mc + pH	€ 1.840,00
ADPS200	Pannello dosaggio pH - CL/Dosing panel pH - CL	€ 2.726,20
700800305	Pompa di calore 2,0 HP/Heat pump 2.0 HP	€ 2.816,00
KASP50	Kit Aspirafango/Mud suction kit	€ 200,00
KCIT128	Copertura invernale completa/Complete winter covering	€ 920,00
200300014	Lampada LED multicolor/Multi coloured LED lamp	€ 367,65
200300013	Lampada LED bianca/White LED lamp	€ 220,00



## APPROFONDIMENTI/ DETAILS

<http://aqua.quickris.com/pool-kit-mt-5-00x10-00-sirio-tipo-b/>



## QR code

Fotografa il codice con lo smartphone e vai direttamente all'approfondimento

Scan the code with your smartphone to obtain more detailed information

## PUBBLICA TIPO B



## POOL KIT mt 6.00X12.00 Sirio - Tipo B

condominiali, destinate all'uso esclusivo degli abitanti del condominio e dei loro ospiti, esclusi i condomini fino a 4 unità abitative.



## POOL KIT 6.00x12.00 m Sirio - Type B

condominium pools, exclusively used by the inhabitants of a block of flats and their guests, excluding blocks of flats up to 4 apartments.

Codice Code	Altezza pannelli altezza acqua Panel height - Water height	Perimetro Perimeter	Area Surface	Volume Volume	Rivestimento in rotoli h 1.65 Azzurro Pool lining - rolls h 1.65: Light Blue	Filtrazione mc/h v 40 Filtration cu. m/h v 40	Consumo in kw Consumption in kW	Aqua flex tubo rotoli mt 25 Aqua flex pipe, 25 m rolls	N° skimmer No. of skimmers	Regolatore di livello Level adjuster	N° bocchette No. of nozzles	N° presa di f. No. of main drains	N° fari led bianchi e blue No. of white and blue LED lights	Listino Price List
Skimmer sfioratore/Overflow skimmer														
KBKDA148	125-130	30.50	58.06	75.58	3	25	1.5x2	4	3	1	3	2	2	€ 21.215,00
KBKDA149	135-140	30.50	58.06	78.39	3	25	1.5x2	4	3	1	3	2	2	€ 21.455,00
Skimmer classic/Skimmer classic														
KBKCA148	120-130	30.50	58.06	69.68	3	25	1.5x2	4	3	1	3	2	2	€ 21.400,00
KBKCA149	140-150	30.50	58.06	81.29	3	25	1.5x2	4	3	1	3	2	2	€ 21.545,00



## OPTIONAL

Codice/Code	Descrizione/Description	Price
ADSALT2100	Sterilizzatore Aqua Salt 100mc + pH/Aqua Salt Steriliser 100mc + pH	€ 1.840,00
ADPS200	Pannello dosaggio pH - CL/Dosing panel pH - CL	€ 2.726,20
700800305	Pompa di calore 2,0 HP/Heat pump 2.0 HP	€ 2.816,00
KASP50	Kit Aspirafango/Mud suction kit	€ 200,00
KCIT129	Copertura invernale completa/Complete winter covering	€ 1.192,00
200300014	Lampada LED multicolor/Multi coloured LED lamp	€ 367,65
200300013	Lampada LED bianca/White LED lamp	€ 220,00



## APPROFONDIMENTI/ DETAILS

<http://aqua.quickris.com/pool-kit-mt-6-00x12-00-sirio-tipo-b/>



## QR code

Fotografa il codice con lo smartphone e vai direttamente all'approfondimento

Scan the code with your smartphone to obtain more detailed information



## PUBBLICA TIPO B



**POOL KIT mt 4.00X8.00 Andromeda - Tipo B**  
condominali, destinate all'uso esclusivo degli abitanti del condominio e dei loro ospiti, esclusi i condomini fino a 4 unità abitative.



*POOL KIT 4.00x8.00 m Andromeda - Type B*  
condominium pools, exclusively used by the inhabitants of a block of flats and their guests, excluding blocks of flats up to 4 apartments.

Codice Code	Altezza pannelli altezza acqua Panel height - Water height	Perimetro Perimeter	Area Surface	Volume Volume	Rivestimento in rotoli h 1.65 Azzurro Pool lining - rolls h 1.65, Light Blue	Filtrazione mc/h v 40 Filtration cu. m/h v 40	Consumo in kw Consumption in kW	Aqua flex tubo rotoli mt 25 Aqua flex pipe, 25 m rolls	N° skimmer No. of skimmers	Regolatore di livello Level adjuster	N° bocchette No. of nozzles	N° presa di f. No. of main drains	N° fari led bianchi e blue No. of white and blue LED lights	Listino Price List
Skimmer sfioratore/Overflow skimmer														
KBKDA150	125-130	21.00	29.45	36.82	2	10	0.75x2	4	2	1	2	2	2	€ 15.865,00
KBKDA151	135-140	21.00	29.45	39.76	2	10	0.75x2	4	2	1	2	2	2	€ 16.060,00
Skimmer classic/Skimmer classic														
KBKCA150	120-130	21.00	29.45	35.34	2	10	0.75x2	4	2	1	2	2	2	€ 15.930,00
KBKCA151	140-150	21.00	29.45	41.23	2	10	0.75x2	4	2	1	2	2	2	€ 16.110,00



## OPTIONAL

Codice/Code	Descrizione/Description	Price
ADSALT2050	Sterilizzatore Aqua Salt 50mc + pH/Aqua Salt Steriliser 50mc + pH	€ 1.700,00
ADPS200	Pannello dosaggio pH - CL/Dosing panel pH - CL	€ 2.726,20
700800304	Pompa di calore 1,5 HP/Heat pump 1.5 HP	€ 2.256,00
KASP50	Kit Aspirafango/Mud suction kit	€ 200,00
KCIT130	Copertura invernale completa/Complete winter covering	€ 706,00
200300014	Lampada LED multicolor/Multi coloured LED lamp	€ 367,65
200300013	Lampada LED bianca/White LED lamp	€ 220,00



## APPROFONDIMENTI/ DETAILS

<http://aqua.quickris.com/pool-kit-mt-4-00x-8-00-andromeda-tipo-b/>



## QR code

Fotografa il codice con lo smartphone e vai direttamente all'approfondimento

Scan the code with your smartphone to obtain more detailed information

## PUBBLICA TIPO B



**POOL KIT mt 5.00X10.00 Andromeda - Tipo B**  
condominiali, destinate all'uso esclusivo degli abitanti del condominio e dei loro ospiti, esclusi i condomini fino a 4 unità abitative.



*POOL KIT 5.00x10.00 m Andromeda - Type B*  
condominium pools, exclusively used by the inhabitants of a block of flats and their guests, excluding blocks of flats up to 4 apartments.

Codice Code	Altezza pannelli altezza acqua Panel height - Water height	Perimetro Perimeter	Area Surface	Volume Volume	Rivestimento in rotoli h 1.65 Azzurro Pool lining - rolls h 1.65: Light Blue	Filtrazione mc/h v 40 Filtration cu. m/h v 40	Consumo in kw Consumption in kW	Aqua flex tubo rotoli mt 25 Aqua flex pipe, 25 m rolls	N° skimmer No. of skimmers	Regolatore di livello Level adjuster	N° bocchette No. of nozzles	N° presa di f. No. of main drains	N° fari led bianchi e blue No. of white and blue LED lights	Listino Price List
<i>Skimmer sfioratore/Overflow skimmer</i>														
KBKDA152	125-130	26.51	46.64	58.30	2½	17	1.1x2	4	2	1	2	2	2	€ 19.560,00
KBKDA153	135-140	26.51	46.64	63.00	2½	17	1.1x2	4	2	1	2	2	2	€ 19.775,00
<i>Skimmer classic/Skimmer classic</i>														
KBKCA152	120-130	26.51	46.64	55.97	2½	17	1.1x2	4	2	1	2	2	2	€ 19.625,00
KBKCA153	140-150	26.51	46.64	65.30	2½	17	1.1x2	4	2	1	2	2	2	€ 19.840,00



## OPTIONAL

Codice/Code	Descrizione/Description	Price
ADSALT2100	Sterilizzatore Aqua Salt 100mc + pH/Aqua Salt Steriliser 100mc + pH	€ 1.840,00
ADPS200	Pannello dosaggio pH - CL/Dosing panel pH - CL	€ 2.726,20
700800305	Pompa di calore 2,0 HP/Heat pump 2.0 HP	€ 2.816,00
KASP50	Kit Aspirafango/Mud suction kit	€ 200,00
KCIT131	Copertura invernale completa/Complete winter covering	€ 938,00
200300014	Lampada LED multicolor/Multi coloured LED lamp	€ 367,65
200300013	Lampada LED bianca/White LED lamp	€ 220,00



## APPROFONDIMENTI/ DETAILS

<http://aqua.quickris.com/pool-kit-mt-5-00x-10-00-andromeda-tipo-b/>



## QR code

Fotografa il codice con lo smartphone e vai direttamente all'approfondimento

Scan the code with your smartphone to obtain more detailed information

## PUBBLICA TIPO B



**POOL KIT mt 6.00X12.00 Andromeda - Tipo B**  
condominiali, destinate all'uso esclusivo degli abitanti del condominio e dei loro ospiti, esclusi i condomini fino a 4 unità abitative.



*POOL KIT 6.00x12.00 m Andromeda - Type B*  
condominium pools, exclusively used by the inhabitants of a block of flats and their guests, excluding blocks of flats up to 4 apartments.

Codice Code	Altezza pannelli altezza acqua Panel height - Water height	Perimetro Perimeter	Area Surface	Volume Volume	Rivestimento in rotoli h 1.65 Azzurro Pool lining - rolls h.1.65, Light Blue	Filtrazione mc/h v 40 Filtration cu. m/h v 40	Consumo in kw Consumption in kW	Aqua flex tubo rotoli mt 25 Aqua flex pipe, 25 m rolls	N° skimmer No. of skimmers	Regolatore di livello Level adjuster	N° bocchette No. of nozzles	N° presa di f. No. of main drains	N° fari led bianchi e blue No. of white and blue LED lights	Listino Price List
Skimmer sfioratore/Overflow skimmer														
KBKDA154	125-130	31.98	67.68	84.60	3	25	1.5x2	4	3	1	3	2	3	€ 22.830,00
KBKDA155	135-140	31.98	67.68	91.37	3	25	1.5x2	4	3	1	3	2	3	€ 23.080,00
Skimmer classic/Skimmer classic														
KBKCA154	120-130	31.98	67.68	81.22	3	25	1.5x2	4	3	1	3	2	3	€ 22.930,00
KBKCA155	140-150	31.98	67.68	94.76	3	25	1.5x2	4	3	1	3	2	3	€ 23.175,00



## OPTIONAL

Codice/Code	Descrizione/Description	Price
ADSALT2100	Sterilizzatore Aqua Salt 100mc + pH/Aqua Salt Steriliser 100mc + pH	€ 1.840,00
ADPS200	Pannello dosaggio pH - CL/Dosing panel pH - CL	€ 2.726,20
700800305	Pompa di calore 2,0 HP/Heat pump 2.0 HP	€ 2.816,00
KASP50	Kit Aspirafango/Mud suction kit	€ 200,00
KCIT132	Copertura invernale completa/Complete winter covering	€ 1.210,00
200300014	Lampada LED multicolor/Multi coloured LED lamp	€ 367,65
200300013	Lampada LED bianca/White LED lamp	€ 220,00



## APPROFONDIMENTI/ DETAILS

<http://aqua.quickris.com/pool-kit-mt-6-00x-12-00-andromeda-tipo-b/>



## QR code

Fotografa il codice con lo smartphone e vai direttamente all'approfondimento

Scan the code with your smartphone to obtain more detailed information

## PRIVATA TIPO D

D

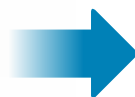

## PRIVATE - TIPO D - SKIMMER

PRIVATE POOLS - TYPE D - SKIMMER



## CAMPO DI UTILIZZO

Piscine al servizio di edifici abitativi mono-, bi-, tri-, e quadrifamiliari.



## CONTEXT OF USE

Swimming pool for residential building mono - bi - tri or four families



## CARATTERISTICHE TECNICHE

## 1) STRUTTURA

Tecnologia a Skimmer H 120cm - 130cm - 140cm - 150cm (vedi tab. pag 135)

## 2) RIVESTIMENTO

PVC armato

## 3) CIRCOLAZIONE

L'immissione in vasca può avvenire dalle pareti o dal fondo, purché si garantisca l'omogeneizzazione.

I sistemi di ripresa immersi e le prese di fondo devono essere sempre collegate in coppia ad una distanza minima di 2 mt.

## 4) FILTRAZIONE

- Velocità di filtrazione  $\delta 50mc/h$
- Pressione di collaudo deve essere  $\epsilon 1,5$  volte superiore alla pressione massima di esercizio.
- Pressione massima di esercizio con un minimo di 350Kpa.
- Deve essere previsto un numero di filtri  $\geq 1$ ; tutti i filtri devono avere medesime caratteristiche.

## 5) ILLUMINAZIONE

- Led

## 6) QUADRO ELETTRICO

- Monofase



## TECHNICAL FEATURES

## 1) STRUCTURE

Skimmer technology H 120cm - 130cm - 140cm - 150cm (see tab. page 135)

## 2) COATING

Reinforced PVC

## 3) CIRCULATION

The return of the water in the pool can be from the wall or from the bottom, provided it is ensure homogenization.

The suction of the swimming pool and the main drain must always be connected in pairs at a minimum distance of 2 meters.

## 4) FILTRATION

- Filtration speed  $\delta 50mc/h$
- Pressure test must be  $\epsilon 1,5$  time higher than the maximum pressure.
- Maximum with a minimum of 350Kpa.
- Must be provided a minimum number of filters  $\geq 1$ ; all the filters must have the same characteristic

## 5) LIGHTING

- Led

## 6) ELECTRICAL BOARD

- Single-phase



**NORMATIVE**

Normativa NTC 2008 - L. n°1086 del 05.11.1971: "Norme per la disciplina delle opere in conglomerato cementizio armato, normale e precompresso e in struttura metallica";  
 Ordinanza n°3274 del 20.03.2003: "Primi elementi in materia di criteri generali per la classificazione sismica del territorio nazionale e di normative tecniche per la costruzione in zona sismica";  
 D.M. del 14.01.2008: "Norme Tecniche per le costruzioni NTC 2008";  
 Circolare ministeriale n°617 del 27.02.2009: "Istruzioni per l'applicazione delle Norme Tecniche per le Costruzioni";  
 EC3: EUROCODICE 3 EN 1993 1-3; 1-5; 1-2.  
 Carichi e movimentazione D. Lgs. 81/08 (ex 626). (MAX KG.30)  
 UNI EN 10637:2006  
 UNI EN 13451-1:2002 e 13451-3:2002 UNI EN 13451-1:2002 e 13451-1:2002

**STANDARDS**

NTC 2008 Standard - Italian Law no. 1086 of 05.11.1971: "Regulations for works in reinforced concrete, pre-stressed reinforced concrete and metal structures";  
 Italian Order no.3274 of 20.03.2003: "Basic notions on general seismic classification criteria for the national territory and technical rules for construction in seismic areas";  
 Italian Ministerial Decree of 14.01.2008: "Technical Standards for Construction NTC 2008";  
 Italian Ministerial Circular no. 617 of 27.02.2009: "Instructions for the application of Technical Standards for Construction";  
 EC3: EUROCODE 3 EN 1993 1-3; 1-5; 1-2.  
 Loads and handling - Italian Legislative Decree 81/08 (ex 626). (MAX KG.30)  
 UNI EN 10637:2006 - UNI EN 13451-1:2002 and 13451-3:2002  
 UNI EN 13451-1:2002 and 13451-1:2002



## PRIVATA TIPO D

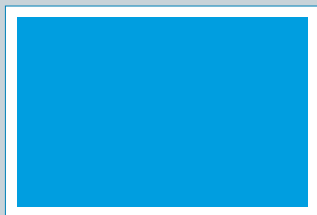

## POOL KIT mt 3.20X7.20 - Tipo D

piscine al servizio di unità abitative monofamiliare, bifamiliari, trifamiliari e quadrifamiliari



## POOL KIT 3.20x7.20 m - Type D

pools for buildings (houses, blocks of flats) with up to four apartments

Codice Code	Altezza pannelli altezza acqua Panel height - Water height	Scala recessa Roman steps	Perimetro Perimeter	Area Surface	Volume Volume	Rivestimento in rotoli h 165 Azzurro Pool lining - rolls h.165. Light Blue	Rivestimento mq Azzurro antiscivolo Pool lining sq. m Light Blue, non-slip	Filtrazione mc/h v 50 Filtration cu. m/h v.50	Consumo in kw Consumption in kW	Aqua flex tubo rotoli mt 25 Aqua flex pipe, 25 m rolls	N° skimmer No. of skimmers	Regolatore di livello Level adjuster	N° bocchette No. of nozzles	N° presa di f. No. of main drains	N° fari led bianchi e blue No. of white and blue LED lights	Listino Price List
Skimmer sfioratore/Overflow skimmer																
KDKDA100	115-120		20.80	23.04	26.50	1.5		6	0.33	2	1	1	1	1	1	€ 10.785,00
KDKDA103	135-140		20.80	23.04	31.10	1.5		6	0.33	2	1	1	1	1	1	€ 11.720,00
Skimmer angolare/Corner skimmer																
KDKAA100	115-120		20.80	23.04	26.50	1.5		6	0.33	2	1	1	2	1	1	€ 10.765,00
KDKAA103	135-140		20.80	23.04	31.10	1.5		6	0.33	2	1	1	1	1	1	€ 11.815,00
Skimmer classic/Skimmer classic																
KDKCA100	110-120		20.80	23.04	25.35	1.5		6	0.33	2	1		1	1	1	€ 10.705,00
KDKCA103	140-150		20.80	32.20	29.95	1.5		10	0.50	2	1		1	1	1	€ 11.895,00

\*Per altezze 120-130 possibilità di tramoggia / For heights 120-130 possibility of hopper

**OPTIONAL**

Codice/Code	Descrizione/Description	Price
ADSALT2050	Sterilizzatore Aqua Salt 50mc + pH/Aqua Salt Steriliser 50mc + pH	€ 1.700,00
ADPS100	Pannello dosaggio pH - Rx/Dosing panel pH - Rx	€ 1.446,12
700800304	Pompa di calore 1,5 HP/Heat pump 1.5 HP	€ 2.256,00
KASP50	Kit Aspirafango/Mud suction kit	€ 200,00
KCIT100	Copertura invernale completa/Complete winter covering	€ 486,00
200300014	Lampada LED multicolor/Multi coloured LED lamp	€ 367,65
200300013	Lampada LED bianca/White LED lamp	€ 220,00



## APPROFONDIMENTI/ DETAILS

<http://aqua.quickris.com/pool-kit-mt-3-20x7-20-tipo-d/>



## QR code

Fotografa il codice con lo smartphone e vai direttamente all'approfondimento

Scan the code with your smartphone to obtain more detailed information

## PRIVATA TIPO D

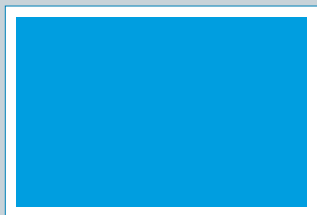

## POOL KIT mt 4.00x8.00 - Tipo D

piscine al servizio di unità abitative monofamiliare, bifamiliari, trifamiliari e quadrifamiliari



POOL KIT 4.00x8.00 m - Type D  
pools for buildings (houses, blocks of flats)  
with up to four apartments

Code Code	Altezza pannelli altezza acqua Panel height - Water height	Scala recessa Roman steps	Perimetro Perimeter	Area Surface	Volume Volume	Rivestimento in rotoli h 165 Azzurro Pool lining - rolls h 165 Light Blue	Rivestimento mq Azzurro antiscivolo Pool lining sq. m Light Blue, non-slip	Filtrazione mc/h v 50 Filtration cu. m/h v 50	Consumo in kw Consumption in kW	Aqua flex tubo rotoli mt 25 Aqua flex pipe, 25 m rolls	N° skimmer No. of skimmers	Regolatore di livello Level adjuster	N° bocchette No. of nozzles	N° presa di f. No. of main drains	N° fari led bianchi e blue No. of white and blue LED lights	Listino Price List
Skimmer sfioratore/Overflow skimmer																
KDKDA106	115-120		24.00	32.00	36.80	2		10	0.50	3	1	1	2	1	1	€ 12.295,00
KDKDA107	115-120	R 1.5	26.40	36.66	39.48	2½	8.25	10	0.50	4	1	1	3	1	1	€ 14.615,00
KDKDA108	115-120	1.6x2.4	27.20	35.84	39.01	2½	8.25	10	0.50	4	1	1	3	1	1	€ 14.420,00
KDKDA109	135-140		24.00	32.00	43.20	2		10	0.50	3	1	1	2	1	1	€ 13.460,00
KDKDA110	135-140	R 1.5	26.40	36.66	46.35	2½	8.25	10	0.50	4	1	1	3	1	1	€ 15.825,00
KDKDA111	135-140	1.6x2.4	27.20	35.84	45.80	2½	8.25	10	0.50	4	1	1	3	1	1	€ 15.745,00
Skimmer angolare/Corner skimmer																
KDKAA106	115-120		24.00	32.00	36.80	2		10	0.50	3	2	1	2	1	1	€ 12.645,00
KDKAA107	115-120	R 1.5	26.40	36.66	39.48	2½	8.25	10	0.50	4	2	1	2	1	1	€ 14.810,00
KDKAA108	115-120	1.6x2.4	27.20	35.84	39.01	2½	8.25	10	0.50	4	2	1	2	1	1	€ 14.760,00
KDKAA109	135-140		24.00	32.00	43.20	2		10	0.50	3	2	1	2	1	1	€ 13.820,00
KDKAA110	135-140	R 1.5	26.40	36.66	46.35	2½	8.25	10	0.50	4	2	1	2	1	1	€ 15.875,00
KDKAA111	135-140	1.6x2.4	27.20	35.84	45.80	2½	8.25	10	0.50	4	2	1	2	1	1	€ 16.080,00
Skimmer classic/Skimmer classic																
KDKCA106	110-120		24.00	32.00	35.20	2		10	0.50	3	1		2	1	1	€ 12.420,00
KDKCA107	110-120	R 1.5	26.40	36.66	37.76	2½	8.25	10	0.50	4	1		3	1	1	€ 14.740,00
KDKCA108	110-120	1.6x2.4	27.20	35.84	37.31	2½	8.25	10	0.50	4	1		3	1	1	€ 14.545,00
KDKCA109	140-150		24.00	32.00	44.80	2		10	0.50	3	1		2	1	1	€ 13.600,00
KDKCA110	140-150	R 1.5	26.40	36.66	48.06	2½	8.25	10	0.50	4	1		3	1	1	€ 15.900,00
KDKCA111	140-150	1.6x2.4	27.20	35.84	47.99	2½	8.25	10	0.50	4	1		3	1	1	€ 15.865,00

\*Per altezze 120-130 possibilità di tramoggia / For heights 120-130 possibility of hopper



## OPTIONAL

Codice/Code	Descrizione/Description	Price
ADSALT2050	Sterilizzatore Aqua Salt 50mc + PH/ Aqua Salt Steriliser 50mc + pH	€ 1.700,00
ADPS100	Pannello dosaggio PH-RX/Dosing panel pH - Rx	€ 1.446,12
700800304	Pompa di calore 1,5HP/Heat pump 1.5HP	€ 2.256,00
KASP50	Kit Aspirafango/Mud suction kit	€ 200,00
KCIT101	Copertura invernale completa/Complete winter covering	€ 580,00
KCIB109	Copertura invernale completa con scaletta romana 1,5/Complete winter covering roman ladder R1.5	€ 753,00
KCIB117	Copertura invernale completa con scaletta romana rett 1,6x2,4/Complete winter covering rett ladder 1,6x2,4	€ 720,00
200300014	Lampada LED multicolor/Multi coloured LED lamp	€ 367,65
200300013	Lampada LED bianca/White LED lamp	€ 220,00



## APPROFONDIMENTI/ DETAILS

<http://aqua.quickris.com/pool-kit-mt-4-00x8-00-tipo-d/>



## QR code

Fotografa il codice con lo smartphone e vai direttamente all'approfondimento

Scan the code with your smartphone to obtain more detailed information



## PRIVATA TIPO D

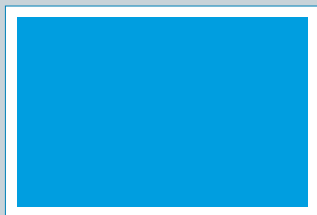

## POOL KIT mt 4.80x9.60 - Tipo D

piscine al servizio di unità abitative monofamiliare, bifamiliari, trifamiliari e quadrifamiliari



POOL KIT 4.80x9.60 m - Type D  
pools for buildings (houses, blocks of flats)  
with up to four apartments

Codice Code	Altezza pannelli altezza acqua Panel height - Water height	Scala recessa Roman steps	Perimetro Perimeter	Area Surface	Volume Volume	Rivestimento in rotoli h 165 Azzurro Pool lining - rolls h 165 Light Blue	Rivestimento mq Azzurro antiscivolo Pool lining sq. m Light Blue, non-slip	Filtrazione mc/h v 50 Filtration cu. m/h v 50	Consumo in kw Consumption in kW	Aqua flex tubo rotoli mt 25 Aqua flex pipe, 25 m rolls	N° skimmer No. of skimmers	Regolatore di livello Level adjuster	N° bocchette No. of nozzles	N° presa di f. No. of main drains	N° fari led bianchi e blue No. of white and blue LED lights	Listino Price List
Skimmer sfioratore/Overflow skimmer																
KDKDA112	115-120		28.80	46.08	53.00	3		14	0.75	4	2	1	2	1	2	€ 16.305,00
KDKDA113	115-120	R 1.5	31.26	50.74	55.67	3½	8.25	14	0.75	4	2	1	3	1	2	€ 18.635,00
KDKDA114	115-120	1.6x2.4	32.00	49.92	55.20	3½	8.25	14	0.75	4	2	1	3	1	2	€ 18.280,00
KDKDA115	135-140		28.80	46.08	62.20	3		14	0.75	4	2	1	2	1	2	€ 17.690,00
KDKDA116	135-140	R 1.5	31.26	50.74	65.35	3½	8.25	14	0.75	4	2	1	3	1	2	€ 20.095,00
KDKDA117	135-140	1.6x2.4	32.00	49.92	64.80	3½	8.25	14	0.75	4	2	1	3	1	2	€ 19.885,00
Skimmer angolare/Corner skimmer																
KDKAA112	115-120		28.80	46.08	53.00	3		14	0.75	3	2	1	2	1	2	€ 14.960,00
KDKAA113	115-120	R 1.5	31.26	50.74	55.67	3½	8.25	14	0.75	4	2	1	3	1	2	€ 17.450,00
KDKAA114	115-120	1.6x2.4	32.00	49.92	55.20	3½	8.25	14	0.75	4	2	1	3	1	2	€ 17.095,00
KDKAA115	135-140		28.80	46.08	62.20	3		14	0.75	3	2	1	2	1	2	€ 16.340,00
KDKAA116	135-140	R 1.5	31.26	50.74	65.35	3½	8.25	14	0.75	4	2	1	3	1	2	€ 18.890,00
KDKAA117	135-140	1.6x2.4	32.00	49.92	64.80	3½	8.25	14	0.75	4	2	1	3	1	2	€ 18.650,00
Skimmer classic/Skimmer classic																
KDKCA112	110-120		28.80	46.08	50.69	3		14	0.75	4	2		2	1	2	€ 15.085,00
KDKCA113	110-120	R 1.5	31.26	50.74	53.25	3½	8.25	14	0.75	4	2		3	1	2	€ 18.600,00
KDKCA114	110-120	1.6x2.4	32.00	49.92	52.80	3½	8.25	14	0.75	4	2		3	1	2	€ 18.245,00
KDKCA115	140-150		28.80	46.08	64.51	3		14	0.75	4	2		2	1	2	€ 17.655,00
KDKCA116	140-150	R 1.5	31.26	50.74	67.78	3½	8.25	14	0.75	4	2		3	1	2	€ 19.980,00
KDKCA117	140-150	1.6x2.4	32.00	49.92	67.20	3½	8.25	14	0.75	4	2		3	1	2	€ 19.800,00

\*Per altezze 120-130 possibilità di tramoggia / For heights 120-130 possibility of hopper

**OPTIONAL**

Codice/Code	Descrizione/Description	Price
ADSALT2100	Sterilizzatore Aqua Salt 100mc + pH/ Aqua Salt Steriliser 100mc + pH	€ 1.840,00
ADPS100	Pannello dosaggio pH - Rx/Dosing panel pH - Rx	€ 1.446,12
700800305	Pompa di calore 2,0HP/Heat pump 2.0HP	€ 2.816,00
KASP50	Kit Aspirafango/Mud suction kit	€ 200,00
KCIT102	Copertura completa invernale/Complete winter covering	€ 722,00
KCIT110	Copertura invernale completa con scaletta romana 1,5/Complete winter covering roman ladder R1.5	€ 930,00
KCIT118	Copertura invernale completa con scaletta romana rett 1,6x2,4/Complete winter covering rett ladder 1,6x2,4	€ 890,00
200300014	Lampada LED multicolor/Multi coloured LED lamp	€ 367,65
200300013	Lampada LED bianca/White LED lamp	€ 220,00

**APPROFONDIMENTI/ DETAILS**

<http://aqua.quickris.com/pool-kit-mt-4-80x9-60-tipo-d/>



**QR code**

Fotografa il codice con lo smartphone e vai direttamente all'approfondimento

Scan the code with your smartphone to obtain more detailed information

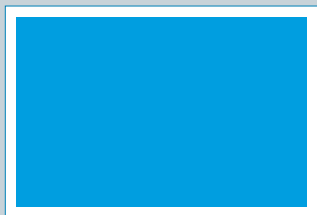

## PRIVATA TIPO D



## POOL KIT mt 5.00x10.00 - Tipo D

piscine al servizio di unità abitative monofamiliare, bifamiliari, trifamiliari e quadrifamiliari



## POOL KIT 5.00x10.00 m - Type D

pools for buildings (houses, blocks of flats) with up to four apartments

Code Code	Altezza pannelli altezza acqua Panel height - Water height	Scala recessa Roman steps	Perimetro Perimeter	Area Surface	Volume Volume	Rivestimento in rotoli h 165 Azzurro Pool lining - rolls h 1.65 Light Blue	Rivestimento mq Azzurro antiscivolo Pool lining sq. m Light Blue, non-slip	Filtrazione mc/h v 50 Filtration cu. m/h v 50	Consumo in kw Consumption in kW	Aqua flex tubo rotoli mt 25 Aqua flex pipe, 25 m rolls	N° skimmer No. of skimmers	Regolatore di livello Level adjuster	N° bocchette No. of nozzles	N° presa di f. No. of main drains	N° fari led bianchi e blue No. of white and blue LED lights	Listino Price List
Skimmer sfioratore/Overflow skimmer																
KDKDA118	115-120		30.00	50.00	57.50	3		14	0.75	4	2	1	2	1	2	€ 17.530,00
KDKDA119	115-120	R 1.5	32.46	54.66	60.18	3½	8.25	14	0.75	4	2	1	3	1	2	€ 19.760,00
KDKDA120	115-120	1.6x2.4	33.20	53.84	59.71	3½	8.25	14	0.75	4	2	1	3	1	2	€ 19.565,00
KDKDA121	135-140		30.00	50.00	67.50	3		14	0.75	4	2	1	2	1	2	€ 18.970,00
KDKDA122	135-140	R 1.5	32.46	54.66	70.65	3½	8.25	14	0.75	4	2	1	3	1	2	€ 21.240,00
KDKDA123	135-140	1.6x2.4	33.20	53.84	70.10	3½	8.25	14	0.75	4	2	1	3	1	2	€ 21.160,00
Skimmer angolare/Corner skimmer																
KDKAA118	115-120		30.00	50.00	57.50	3		14	0.75	3	2	1	2	1	2	€ 16.185,00
KDKAA119	115-120	R 1.5	32.46	54.66	60.18	3½	8.25	14	0.75	4	2	1	3	1	2	€ 18.555,00
KDKAA120	115-120	1.6x2.4	33.20	53.84	59.71	3½	8.25	14	0.75	4	2	1	3	1	2	€ 18.365,00
KDKAA121	135-140		30.00	50.00	67.50	3		14	0.75	3	2	1	2	1	2	€ 17.650,00
KDKAA122	135-140	R 1.5	32.46	54.66	70.65	3½	8.25	14	0.75	4	2	1	3	1	2	€ 20.035,00
KDKAA123	135-140	1.6x2.4	33.20	53.84	70.10	3½	8.25	14	0.75	4	2	1	3	1	2	€ 19.955,00
Skimmer classic/Skimmer classic																
KDKCA118	110-120		30.00	50.00	55.00	3		14	0.75	4	2		2	1	2	€ 17.510,00
KDKCA119	110-120	R 1.5	32.46	54.66	57.56	3½	8.25	14	0.75	4	2		3	1	2	€ 19.705,00
KDKCA120	110-120	1.6x2.4	33.20	53.84	57.11	3½	8.25	14	0.75	4	2		3	1	2	€ 19.510,00
KDKCA121	140-150		30.00	50.00	70.00	3		14	0.75	4	2		2	1	2	€ 18.945,00
KDKCA122	140-150	R 1.5	32.46	54.66	73.26	3½	8.25	14	0.75	4	2		3	1	2	€ 21.155,00
KDKCA123	140-150	1.6x2.4	33.20	53.84	72.68	3½	8.25	14	0.75	4	2		3	1	2	€ 21.120,00

\*Per altezze 120-130 possibilità di tramoggia / For heights 120-130 possibility of hopper

**OPTIONAL**

Codice/Code	Descrizione/Description	Price
ADSALT2100	Sterilizzatore Aqua Salt 100mc + pH/ Aqua Salt Steriliser 100mc + pH	€ 1.840,00
ADPS100	Pannello dosaggio pH - Rx/Dosing panel pH - Rx	€ 1.446,12
700800305	Pompa di calore 2,0HP/Heat pump 2.0HP	€ 2.816,00
KASP50	Kit Aspirafango/Mud suction kit	€ 200,00
KCIT103	Copertura completa invernale/Complete winter covering	€ 757,00
KCIT111	Copertura invernale completa con scaletta romana 1,5/Complete winter covering roman ladder R1.5	€ 980,00
KCIT119	Copertura invernale completa con scaletta romana rett 1,6x2,4/Complete winter covering rett ladder 1,6x2,4	€ 930,00
200300014	Lampada LED multicolor/Multi coloured LED lamp	€ 367,65
200300013	Lampada LED bianca/White LED lamp	€ 220,00



## APPROFONDIMENTI/ DETAILS

<http://aqua.quickris.com/pool-kit-mt-5-00x10-00-tipo-d/>



## QR code

Fotografa il codice con lo smartphone e vai direttamente all'approfondimento

Scan the code with your smartphone to obtain more detailed information

## PRIVATA TIPO D

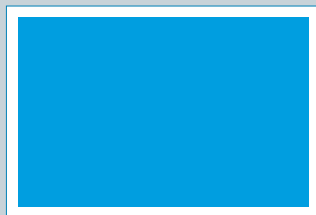

## POOL KIT mt 5.60x11.20 - Tipo D

piscine al servizio di unità abitative monofamiliare, bifamiliari, trifamiliari e quadrifamiliari



POOL KIT 5.60x11.20 m - Type D  
pools for buildings (houses, blocks of flats)  
with up to four apartments

Codice Code	Altezza pannelli altezza acqua Panel height - Water height	Scala recessa Roman steps	Perimetro Perimeter	Area Surface	Volume Volume	Rivestimento in rotoli h 165 Azzurro Pool lining - rolls h.165 Light Blue	Rivestimento mq Azzurro antiscivolo Pool lining sq. m Light Blue, non-slip	Filtrazione mc/h v 50 Filtration cu. m/h v 50	Consumo in kw Consumption in kW	Aqua flex tubo rotoli mt 25 Aqua flex pipe, 25 m rolls	N° skimmer No. of skimmers	Regolatore di livello Level adjuster	N° bocchette No. of nozzles	N° presa di f. No. of main drains	N° fari led bianchi e blue No. of white and blue LED lights	Listino Price List
Skimmer sfioratore/Overflow skimmer																
KDKDA124	115-120		33.60	62.72	72.13	3½		22	1.5	4	2	1	2	1	3	€ 18.520,00
KDKDA125	115-120	R 1.5	36.06	67.38	74.80	4	8.25	22	1.5	4	2	1	3	1	3	€ 20.660,00
KDKDA126	115-120	1.6x2.4	36.80	66.56	74.34	4	8.25	22	1.5	4	2	1	3	1	3	€ 20.440,00
KDKDA127	135-140		33.60	62.72	84.67	3½		22	1.5	4	2	1	2	1	3	€ 20.190,00
KDKDA128	135-140	R 1.5	36.06	67.38	87.82	4	8.25	22	1.5	4	2	1	3	1	3	€ 22.325,00
KDKDA129	135-140	1.6x2.4	36.80	66.56	87.26	4	8.25	22	1.5	4	2	1	3	1	3	€ 22.220,00
Skimmer angolare/Corner skimmer																
KDKAA124	115-120		33.60	62.72	72.13	3½		22	1.5	3	2	1	2	1	3	€ 18.375,00
KDKAA125	115-120	R 1.5	36.06	67.38	74.80	4	8.25	22	1.5	4	2	1	3	1	3	€ 20.695,00
KDKAA126	115-120	1.6x2.4	36.80	66.56	74.34	4	8.25	22	1.5	4	2	1	3	1	3	€ 20.470,00
KDKAA127	135-140		33.60	62.72	84.67	3½		22	1.5	3	2	1	2	1	3	€ 19.995,00
KDKAA128	135-140	R 1.5	36.06	67.38	87.82	4	8.25	22	1.5	4	2	1	3	1	3	€ 22.355,00
KDKAA129	135-140	1.6x2.4	36.80	66.56	87.26	4	8.25	22	1.5	4	2	1	3	1	3	€ 22.245,00
Skimmer classic/Skimmer classic																
KDKCA124	110-120		33.60	62.72	69.00	3½		22	1.5	4	2		2	1	3	€ 19.685,00
KDKCA125	110-120	R 1.5	36.06	67.38	71.56	4	8.25	22	1.5	4	2		3	1	3	€ 21.860,00
KDKCA126	110-120	1.6x2.4	36.80	66.56	71.10	4	8.25	22	1.5	4	2		3	1	3	€ 21.655,00
KDKCA127	140-150		33.60	62.72	87.80	3½		22	1.5	4	2		2	1	3	€ 21.320,00
KDKCA128	140-150	R 1.5	36.06	67.38	91.07	4	8.25	22	1.5	4	2		3	1	3	€ 23.475,00
KDKCA129	140-150	1.6x2.4	36.80	66.56	90.50	4	8.25	22	1.5	4	2		3	1	3	€ 23.410,00

\*Per altezze 120-130 possibilità di tramoggia / For heights 120-130 possibility of hopper

**OPTIONAL**

Codice/Code	Descrizione/Description	Price
ADSALT2100	Sterilizzatore Aqua Salt 100mc + pH/ Aqua Salt Steriliser 100mc + pH	€ 1.840,00
ADPS100	Pannello dosaggio pH - Rx/Dosing panel pH - Rx	€ 1.446,12
700800306	Pompa di calore 2,5HP/Heat pump 2.5HP	€ 3.639,00
KASP50	Kit Aspirafango/Mud suction kit	€ 200,00
KCIT104	Copertura completa invernale/Complete winter covering	€ 878,00
KCIT112	Copertura invernale completa con scaletta romana 1,5/Complete winter covering roman ladder R1.5	€ 1.123,00
KCIT120	Copertura invernale completa con scaletta romana rett 1,6x2,4/Complete winter covering rett ladder 1,6x2,4	€ 1.075,00
200300014	Lampada LED multicolor/Multi coloured LED lamp	€ 367,65
200300013	Lampada LED bianca/White LED lamp	€ 220,00

**APPROFONDIMENTI/ DETAILS**

<http://aqua.quickris.com/pool-kit-mt-5-60x11-20-tipo-d/>

**QR code**

Fotografa il codice con lo smartphone e vai direttamente all'approfondimento

Scan the code with your smartphone to obtain more detailed information

## PRIVATA TIPO D

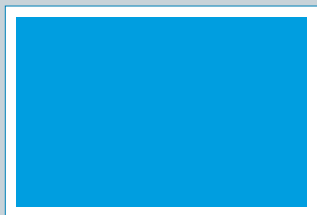

## POOL KIT mt 6.00x12.00 - Tipo D

piscine al servizio di unità abitative monofamiliare, bifamiliari, trifamiliari e quadrifamiliari



## POOL KIT 6.00x12.00 m - Type D

pools for buildings (houses, blocks of flats) with up to four apartments

Code Code	Altezza pannelli altezza acqua Panel height - Water height	Scala recessa Roman steps	Perimetro Perimeter	Area Surface	Volume Volume	Rivestimento in rotoli h 165 Azzurro Pool lining - rolls h 165 Light Blue	Rivestimento mq Azzurro antiscivolo Pool lining sq. m Light Blue, non-slip	Filtrazione mc/h v 50 Filtration cu. m/h v 50	Consumo in kw Consumption in kW	Aqua flex tubo rotoli mt 25 Aqua flex pipe, 25 m rolls	N° skimmer No. of skimmers	Regolatore di livello Level adjuster	N° bocchette No. of nozzles	N° presa di f. No. of main drains	N° fari led bianchi e blue No. of white and blue LED lights	Listino Price List
Skimmer sfioratore/Overflow skimmer																
KDKDA130	115-120		36.00	72.00	82.80	4		22	1.5	4	3	1	3	1	3	€ 20.115,00
KDKDA131	115-120	R 1.5	38.46	76.66	85.48	4	8.25	22	1.5	5	3	1	4	1	3	€ 22.170,00
KDKDA132	115-120	1.6x2.4	39.20	75.84	85.01	4	8.25	22	1.5	5	3	1	4	1	3	€ 21.845,00
KDKDA133	135-140		36.00	72.00	97.20	4		22	1.5	4	3	1	3	1	3	€ 21.835,00
KDKDA134	135-140	R 1.5	38.46	76.66	100.36	4	8.25	22	1.5	5	3	1	4	1	3	€ 23.935,00
KDKDA135	135-140	1.6x2.4	39.20	75.84	99.80	4	8.25	22	1.5	5	3	1	4	1	3	€ 23.720,00
Skimmer angolare/Corner skimmer																
KDKDA130	115-120		36.00	72.00	82.80	4		22	1.5	5	3	1	3	1	3	€ 20.340,00
KDKAA131	115-120	R 1.5	38.46	76.66	85.48	4	8.25	22	1.5	5	3	1	4	1	3	€ 22.220,00
KDKAA132	115-120	1.6x2.4	39.20	75.84	85.01	4	8.25	22	1.5	5	3	1	4	1	3	€ 21.890,00
KDKAA133	135-140		36.00	72.00	97.20	4		22	1.5	5	3	1	3	1	3	€ 22.060,00
KDKAA134	135-140	R 1.5	38.46	76.66	100.36	4	8.25	22	1.5	5	3	1	4	1	3	€ 23.980,00
KDKAA135	135-140	1.6x2.4	39.20	75.84	99.80	4	8.25	22	1.5	5	3	1	4	1	3	€ 23.765,00
Skimmer classic/Skimmer classic																
KDKCA130	110-120		36.00	72.00	79.20	4		22	1.5	4	3		3	1	3	€ 20.130,00
KDKCA131	110-120	R 1.5	38.46	76.66	81.76	4	8.25	22	1.5	5	3		4	1	3	€ 22.190,00
KDKCA132	110-120	1.6x2.4	39.20	75.84	81.31	4	8.25	22	1.5	5	3		4	1	3	€ 21.865,00
KDKCA133	140-150		36.00	72.00	100.80	4		22	1.5	4	3		3	1	3	€ 21.845,00
KDKCA134	140-150	R 1.5	38.46	76.66	104.06	4	8.25	22	1.5	5	3		4	1	3	€ 23.900,00
KDKCA135	140-150	1.6x2.4	39.20	75.84	103.49	4	8.25	22	1.5	5	3		4	1	3	€ 23.735,00

\*Per altezze 120-130 possibilità di tramoggia / For heights 120-130 possibility of hopper

## OPTIONAL

Codice/Code	Descrizione/Description	Price
ADSALT2100	Sterilizzatore Aqua Salt 100mc + pH/ Aqua Salt Steriliser 100mc + pH	€ 1.840,00
ADPS100	Pannello dosaggio pH - Rx/Dosing panel pH - Rx	€ 1.446,12
700800306	Pompa di calore 2,5HP/Heat pump 2,5HP	€ 3.639,00
KASP50	Kit Aspirafango/Mud suction kit	€ 200,00
KCIT105	Copertura completa invernale/Complete winter covering	€ 960,00
KCIT113	Copertura invernale completa con scaletta romana 1,5/Complete winter covering roman ladder R1.5	€ 1.230,00
KCIT121	Copertura invernale completa con scaletta romana rett 1,6x2,4/Complete winter covering rett ladder 1,6x2,4	€ 1.166,00
200300014	Lampada LED multicolor/Multi coloured LED lamp	€ 367,65
200300013	Lampada LED bianca/White LED lamp	€ 220,00



## APPROFONDIMENTI/ DETAILS

<http://aqua.quickris.com/pool-kit-mt-6-00x12-00-tipo-d/>



## QR code

Fotografa il codice con lo smartphone e vai direttamente all'approfondimento

Scan the code with your smartphone to obtain more detailed information

## PRIVATA TIPO D

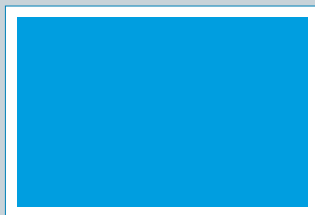

## POOL KIT mt 6.40x12.80 - Tipo D

piscine al servizio di unità abitative monofamiliare, bifamiliari, trifamiliari e quadrifamiliari



## POOL KIT 6.40x12.80 m - Type D

pools for buildings (houses, blocks of flats) with up to four apartments

Codice Code	Altezza pannelli altezza acqua Panel height - Water height	Scala recessa Roman steps	Perimetro Perimeter	Area Surface	Volume Volume	Rivestimento in rotoli h 165 Azzurro Pool lining - rolls h 165 Light Blue	Rivestimento mq Azzurro antiscivolo Pool lining sq. m Light Blue, non-slip	Filtrazione mc/h v 50 Filtration cu. m/h v 50	Consumo in kw Consumption in kW	Aqua flex tubo rotoli mt 25 Aqua flex pipe, 25 m rolls	N° skimmer No. of skimmers	Regolatore di livello Level adjuster	N° bocchette No. of nozzles	N° presa di f. No. of main drains	N° fari led bianchi e blue No. of white and blue LED lights	Listino Price List
Skimmer sfioratore/Overflow skimmer																
KDKDA136	115-120		38.40	81.92	94.21	4½		22	1.5	4	3	1	3	1	3	€ 21.055,00
KDKDA137	115-120	R 1.5	40.86	86.58	96.89	5	8.25	22	1.5	5	3	1	4	1	3	€ 23.675,00
KDKDA138	115-120	1.6x2.4	41.60	85.76	96.42	5	8.25	22	1.5	5	3	1	4	1	3	€ 23.320,00
KDKDA139	135-140		38.40	81.92	110.59	4½		22	1.5	4	3	1	3	1	3	€ 22.885,00
KDKDA140	135-140	R 1.5	40.86	86.58	113.74	5	8.25	22	1.5	5	3	1	4	1	3	€ 25.545,00
KDKDA141	135-140	1.6x2.4	41.60	85.76	113.19	5	8.25	22	1.5	5	3	1	4	1	3	€ 23.750,00
Skimmer angolare/Corner skimmer																
KDKAA136	115-120		38.40	81.92	94.21	4½		22	1.5	5	3	1	3	1	3	€ 21.280,00
KDKAA137	115-120	R 1.5	40.86	86.58	96.89	5	8.25	22	1.5	5	3	1	4	1	3	€ 23.720,00
KDKAA138	115-120	1.6x2.4	41.60	85.76	96.42	5	8.25	22	1.5	5	3	1	4	1	3	€ 23.365,00
KDKAA139	135-140		38.40	81.92	110.59	4½		22	1.5	5	3	1	3	1	3	€ 23.110,00
KDKAA140	135-140	R 1.5	40.86	86.58	113.74	5	8.25	22	1.5	5	3	1	4	1	3	€ 25.590,00
KDKAA141	135-140	1.6x2.4	41.60	85.76	113.19	5	8.25	22	1.5	5	3	1	4	1	3	€ 25.350,00
Skimmer classic/Skimmer classic																
KDKCA136	110-120		38.40	81.92	90.11	4½		22	1.5	4	3		3	1	3	€ 21.055,00
KDKCA137	110-120	R 1.5	40.86	86.58	92.68	5	8.25	22	1.5	5	3		4	1	3	€ 23.675,00
KDKCA138	110-120	1.6x2.4	41.60	85.76	92.22	5	8.25	22	1.5	5	3		4	1	3	€ 23.320,00
KDKCA139	140-150		38.40	81.92	114.69	4½		22	1.5	4	3		3	1	3	€ 22.910,00
KDKCA140	140-150	R 1.5	40.86	86.58	117.95	5	8.25	22	1.5	5	3		4	1	3	€ 25.510,00
KDKCA141	140-150	1.6x2.4	41.60	85.76	117.38	5	8.25	22	1.5	5	3		4	1	3	€ 25.315,00

\*Per altezze 120-130 possibilità di tramoggia / For heights 120-130 possibility of hopper

**OPTIONAL**

Codice/Code	Descrizione/Description	Price
ADSALT2150	Sterilizzatore Aqua Salt 150mc + pH/ Aqua Salt Steriliser 150mc + pH	€ 2.190,00
ADPSI01	Pannello dosaggio pH - Rx/Dosing panel pH - Rx	€ 1.494,86
700800307	Pompa di calore 3,0HP/Heat pump 3.0HP	€ 4.144,00
KASP50	Kit Aspirafango/Mud suction kit	€ 200,00
KCIT106	Copertura completa invernale/Complete winter covering	€ 1.054,00
KCIT114	Copertura invernale completa con scaletta romana 1,5/Complete winter covering roman ladder R1.5	€ 1.338,00
KCIT122	Copertura invernale completa con scaletta romana rett 1,6x2,4/Complete winter covering rett ladder 1,6x2,4	€ 1.282,00
200300014	Lampada LED multicolor/Multi coloured LED lamp	€ 367,65
200300013	Lampada LED bianca/White LED lamp	€ 220,00

**APPROFONDIMENTI/ DETAILS**

<http://aqua.quickris.com/pool-kit-mt-6-40x12-80-tipo-d/>



**QR code**

Fotografa il codice con lo smartphone e vai direttamente all'approfondimento

Scan the code with your smartphone to obtain more detailed information

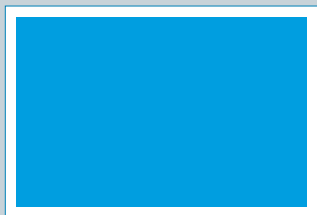

## PRIVATA TIPO D



## POOL KIT mt 7.00x14.00 - Tipo D

piscine al servizio di unità abitative monofamiliare, bifamiliari, trifamiliari e quadrifamiliari



## POOL KIT 7.00x14.00 m - Type D

pools for buildings (houses, blocks of flats) with up to four apartments

Code Code	Altezza pannelli altezza acqua Panel height - Water height	Scala recessa Roman steps	Perimetro Perimeter	Area Surface	Volume Volume	Rivestimento in rotoli h 165 Azzurro Pool lining - rolls h 165 Light Blue	Rivestimento mq Azzurro antiscivolo Pool lining sq. m Light Blue, non-slip	Filtrazione mc/h v 50 Filtration cu. m/h v 50	Consumo in kw Consumption in kW	Aqua flex tubo rotoli mt 25 Aqua flex pipe, 25 m rolls	N° skimmer No. of skimmers	Regolatore di livello Level adjuster	N° bocchette No. of nozzles	N° presa di f. No. of main drains	N° fari led bianchi e blue No. of white and blue LED lights	Listino Price List
Skimmer sfioratore/Overflow skimmer																
KDKDA142	115-120		42.00	98.00	112.70	5		30	2.2	4	3	1	3	1	4	€ 23.640,00
KDKDA145	135-140		42.00	98.00	132.30	4½		30	2.2	4	3	1	3	1	4	€ 25.635,00
Skimmer angolare/Corner skimmer																
KDKAA142	115-120		42.00	98.00	112.70	5		30	2.2	5	3	1	3	1	4	€ 23.865,00
KDKAA145	135-140		42.00	98.00	132.30	4½		30	2.2	5	3	1	3	1	4	€ 25.860,00
Skimmer classic/Skimmer classic																
KDKCA142	110-120		42.00	98.00	107.80	5		30	2.2	4	3		3	1	4	€ 23.640,00
KDKCA145	140-150		42.00	98.00	137.20	4½		30	2.2	4	3		3	1	4	€ 25.660,00

\*Per altezze 120-130 possibilità di tramoggia / For heights 120-130 possibility of hopper



## OPTIONAL

Codice/Code	Descrizione/Description	Price
ADSALT2150	Sterilizzatore Aqua Salt 150mc + pH/ Aqua Salt Steriliser 150mc + pH	€ 2.190,00
ADPS101	Pannello dosaggio pH - Rx/Dosing panel pH - Rx	€ 1.494,86
700800307	Pompa di calore 3,0HP/Heat pump 3.0HP	€ 4.144,00
KASP50	Kit Aspirafango/Mud suction kit	€ 200,00
KCIT107	Copertura completa invernale/Complete winter covering	€ 1.185,00
KCIT115	Copertura invernale completa con scaletta romana 1,5/Complete winter covering roman ladder R1.5	€ 1.510,00
KCIT123	Copertura invernale completa con scaletta romana rett 1,6x2,4/Complete winter covering rett ladder 1,6x2,4	€ 1.437,00
200300014	Lampada LED multicolor/Multi coloured LED lamp	€ 367,65
200300013	Lampada LED bianca/White LED lamp	€ 220,00



## APPROFONDIMENTI/ DETAILS

<http://aqua.quickris.com/pool-kit-mt-7-00x14-00-tipo-d/>



## QR code

Fotografa il codice con lo smartphone e vai direttamente all'approfondimento

Scan the code with your smartphone to obtain more detailed information

## PRIVATA TIPO D



**POOL KIT mt 4.00X8.00 Orione - Tipo D**  
piscine al servizio di unità abitative monofamiliare, bifamiliari,  
trifamiliari e quadrifamiliari



*POOL KIT 4.00x8.00 m Orione - Type D*  
*pools for buildings (houses, blocks of flats)*  
*with up to four apartments*

Codice Code	Altezza pannelli altezza acqua Panel height - Water height	Perimetro Perimeter	Area Surface	Volume Volume	Rivestimento in rotoli h 1.65 Azzurro Pool lining - rolls h 1.65: Light Blue	Filtrazione mc/h v 50 Filtration cu. m/h v 50	Consumo in kw Consumption in kW	Aqua flex tubo rotoli mt 25 Aqua flex pipe, 25 m rolls	N° skimmer No. of skimmers	Regolatore di livello Level adjuster	N° bocchette No. of nozzles	N° presa di f. No. of main drains	N° fari led bianchi e blue No. of white and blue LED lights	Listino Price List
<i>Skimmer sfioratore/Overflow skimmer</i>														
KDKDA148	115-120	22.28	30.28	34.82	2	10	0.50	3	1	1	2	1	2	€ 12.740,00
KDKDA149	135-140	22.28	30.28	40.88	2	10	0.50	3	1	1	2	1	2	€ 13.715,00
<i>Skimmer classic/Skimmer classic</i>														
KDKCA148	110-120	22.28	30.28	33.31	2	10	0.50	3	1	1	2	1	2	€ 12.860,00
KDKCA149	140-150	22.28	30.28	42.40	2	10	0.50	3	1	1	2	1	2	€ 13.835,00



## OPTIONAL

Codice/Code	Descrizione/Description	Price
ADSALT2050	Sterilizzatore Aqua Salt 50mc + pH/ Aqua Salt Steriliser 50mc + pH	€ 1.700,00
ADPS100	Pannello dosaggio pH - Rx/Dosing panel pH - Rx	€ 1.446,12
700800304	Pompa di calore 1,5HP/Heat pump 1.5HP	€ 2.256,00
KASP50	Kit Aspirafango/Mud suction kit	€ 200,00
KCIT124	Copertura completa invernale/Complete winter covering	€ 706,00
200300014	Lampada LED multicolor/Multi coloured LED lamp	€ 367,65
200300013	Lampada LED bianca/White LED lamp	€ 220,00



## APPROFONDIMENTI/ DETAILS

<http://aqua.quickris.com/pool-kit-mt-4-00x8-00-orione-tipo-d/>



## QR code

Fotografa il codice con lo smartphone e vai direttamente all'approfondimento

Scan the code with your smartphone to obtain more detailed information

## PRIVATA TIPO D



**POOL KIT mt 5.00X10.00 Orione - Tipo D**  
piscine al servizio di unità abitative monofamiliare, bifamiliari,  
trifamiliari e quadrifamiliari



*POOL KIT 5.00x10.00 m Orione - Type D*  
*pools for buildings (houses, blocks of flats)*  
*with up to four apartments*

Codice Code	Altezza pannelli altezza acqua Panel height - Water height	Perimetro Perimeter	Area Surface	Volume Volume	Rivestimento in rotoli h 1.65 Azzurro Pool lining - rolls h 1.65, Light Blue	Filtrazione mc/h v 40 Filtration cu. m/h v 40	Consumo in kw Consumption in kW	Aqua flex tubo rotoli mt 25 Aqua flex pipe, 25 m rolls	N° skimmer No. of skimmers	Regolatore di livello Level adjuster	N° bocchette No. of nozzles	N° presa di f. No. of main drains	N° fari led bianchi e blue No. of white and blue LED lights	Listino Price List
Skimmer sfioratore/Overflow skimmer														
KDKDA150	115-120	27.85	47.32	54.41	2½	14	0.75	4	2	1	2	1	2	€ 15.750,00
KDKDA151	135-140	27.85	47.32	63.89	2½	14	0.75	4	2	1	2	1	2	€ 16.930,00
Skimmer classic/Skimmer classic														
KDKCA150	110-120	22.28	47.32	52.05	2½	14	0.75	4	2		2	1	2	€ 15.735,00
KDKCA151	140-150	22.28	47.32	66.25	2½	14	0.75	4	2		2	1	2	€ 15.790,00



## OPTIONAL

Codice/Code	Descrizione/Description	Price
ADSALT2100	Sterilizzatore Aqua Salt 100mc + pH/ Aqua Salt Steriliser 100mc + pH	€ 1.840,00
ADPS100	Pannello dosaggio pH - Rx/Dosing panel pH - Rx	€ 1.446,12
700800305	Pompa di calore 2,0HP/Heat pump 2.0HP	€ 2.816,00
KASP50	Kit Aspirafango/Mud suction kit	€ 200,00
KCIT125	Copertura completa invernale/Complete winter covering	€ 946,00
200300014	Lampada LED multicolor/Multi coloured LED lamp	€ 367,65
200300013	Lampada LED bianca/White LED lamp	€ 220,00



## APPROFONDIMENTI/ DETAILS

<http://aqua.quickris.com/pool-kit-mt-5-00x10-00-orione-tipo-d/>



## QR code

Fotografa il codice con lo smartphone e vai direttamente all'approfondimento

Scan the code with your smartphone to obtain more detailed information

## PRIVATA TIPO D



## POOL KIT mt 6.00X12.00 Orione - Tipo D

piscine al servizio di unità abitative monofamiliare, bifamiliari, trifamiliari e quadrifamiliari



## POOL KIT 6.00x12.00 m Orione - Type D

pools for buildings (houses, blocks of flats)  
with up to four apartments

Codice Code	Altezza pannelli altezza acqua Panel height - Water height	Perimetro Perimeter	Area Surface	Volume Volume	Rivestimento in rotoli h 1.65 Azzurro Pool lining - rolls h 1.65: Light Blue	Filtrazione mc/h v 50 Filtration cu. m/h v 50	Consumo in kw Consumption in kW	Aqua flex tubo rotoli mt 25 Aqua flex pipe, 25 m rolls	N° skimmer No. of skimmers	Regolatore di livello Level adjuster	N° bocchette No. of nozzles	N° presa di f. No. of main drains	N° fari led bianchi e blue No. of white and blue LED lights	Listino Price List
Skimmer sfioratore/Overflow skimmer														
KDKDA152	115-120	33.42	68.14	78.36	3½	22	1.5	4	2	1	2	1	2	€ 18.725,00
KDKDA153	135-140	33.42	68.14	91.99	3½	22	1.5	4	2	1	2	1	2	€ 19.935,00
Skimmer classic/Skimmer classic														
KDKCA152	110-120	33.42	68.14	74.96	3½	22	1.5	4	2		2	1	2	€ 18.555,00
KDKCA153	140-150	33.42	68.14	95.40	3½	22	1.5	4	2		2	1	2	€ 20.105,00



## OPTIONAL

Codice/Code	Descrizione/Description	Price
ADSALT2100	Sterilizzatore Aqua Salt 100mc + pH/ Aqua Salt Steriliser 100mc + pH	€ 1.840,00
ADPS100	Pannello dosaggio pH - Rx/Dosing panel pH - Rx	€ 1.446,12
700800305	Pompa di calore 2,0HP/Heat pump 2.0HP	€ 2.816,00
KASP50	Kit Aspirafango/Mud suction kit	€ 200,00
KCIT126	Copertura completa invernale/Complete winter covering	€ 1.222,00
200300014	Lampada LED multicolor/Multi coloured LED lamp	€ 367,65
200300013	Lampada LED bianca/White LED lamp	€ 220,00



## APPROFONDIMENTI/ DETAILS

<http://aqua.quickris.com/pool-kit-mt-6-00x12-00-orione-tipo-d/>



## QR code

Fotografa il codice con lo smartphone e vai direttamente all'approfondimento

Scan the code with your smartphone to obtain more detailed information



## PRIVATA TIPO D

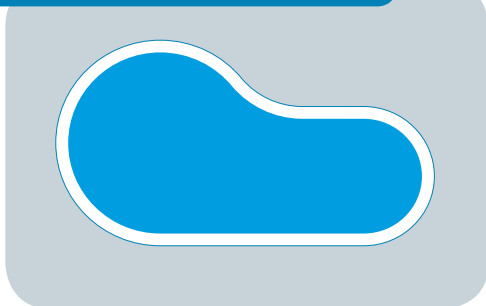

**POOL KIT mt 4.00X8.00 Sirio - Tipo D**  
piscine al servizio di unità abitative monofamiliare, bifamiliari,  
trifamiliari e quadrifamiliari



*POOL KIT 4.00x8.00 m Sirio - Type D*  
*pools for buildings (houses, blocks of flats)*  
*with up to four apartments*

Codice Code	Altezza pannelli altezza acqua Panel height - Water height	Perimetro Perimeter	Area Surface	Volume Volume	Rivestimento in rotoli h 1.65 Azzurro Pool lining - rolls h 1.65, Light Blue	Filtrazione mc/h v 50 Filtration cu. m/h v 50	Consumo in kw Consumption in kW	Aqua flex tubo rotoli mt 25 Aqua flex pipe, 25 m rolls	N° skimmer No. of skimmers	Regolatore di livello Level adjuster	N° bocchette No. of nozzles	N° presa di f. No. of main drains	N° fari led bianchi e blue No. of white and blue LED lights	Listino Price List
Skimmer sfioratore/Overflow skimmer														
KDKDA154	115-120	20.24	24.64	28.34	2	10	0.50	3	1	1	2	1	1	€ 12.235,00
KDKDA155	135-140	20.24	24.64	33.27	2	10	0.50	3	1	1	2	1	1	€ 12.920,00
Skimmer classic/Skimmer classic														
KDKCA154	110-120	20.24	24.64	27.10	2	10	0.50	3	1		2	1	1	€ 12.315,00
KDKCA155	140-150	20.24	24.64	34.50	2	10	0.50	3	1		2	1	1	€ 13.050,00



## OPTIONAL

Codice/Code	Descrizione/Description	Price
ADSALT2050	Sterilizzatore Aqua Salt 50mc + pH/ Aqua Salt Steriliser 50mc + pH	€ 1.700,00
ADPS100	Pannello dosaggio pH - Rx/Dosing panel pH - Rx	€ 1.446,12
700800304	Pompa di calore 1,5HP/Heat pump 1.5HP	€ 2.256,00
KASP50	Kit Aspirafango/Mud suction kit	€ 200,00
KCIT127	Copertura completa invernale/Complete winter covering	€ 688,00
200300014	Lampada LED multicolor/Multi coloured LED lamp	€ 367,65
200300013	Lampada LED bianca/White LED lamp	€ 220,00



## APPROFONDIMENTI/ DETAILS

<http://aqua.quickris.com/pool-kit-mt-4-00x8-00-sirio-tipo-d/>



## QR code

Fotografa il codice con lo smartphone e vai direttamente all'approfondimento

Scan the code with your smartphone to obtain more detailed information

## PRIVATA TIPO D

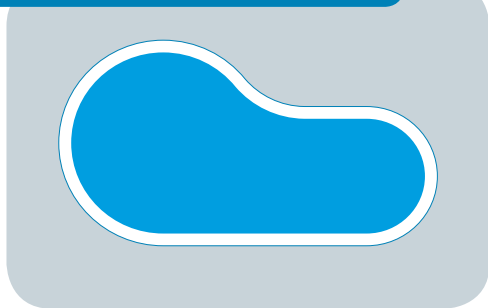

## POOL KIT mt 5.00X10.00 Sirio - Tipo D

piscine al servizio di unità abitative monofamiliare, bifamiliari, trifamiliari e quadrifamiliari



## POOL KIT 5.00x10.00 m Sirio - Type D

pools for buildings (houses, blocks of flats)  
with up to four apartments

Codice Code	Altezza pannelli altezza acqua Panel height - Water height	Perimetro Perimeter	Area Surface	Volume Volume	Rivestimento in rotoli h 1.65 Azzurro Pool lining - rolls h 1.65: Light Blue	Filtrazione mc/h v 50 Filtration cu. m/h v 50	Consumo in kw Consumption in kW	Aqua flex tubo rotoli mt 25 Aqua flex pipe, 25 m rolls	N° skimmer No. of skimmers	Regolatore di livello Level adjuster	N° bocchette No. of nozzles	N° presa di f. No. of main drains	N° fari led bianchi e blue No. of white and blue LED lights	Listino Price List
Skimmer sfioratore/Overflow skimmer														
KDKDA156	115-120	25.37	39.56	45.50	2½	14	0.75	4	2	1	2	1	2	€ 15.460,00
KDKDA157	135-140	25.37	39.56	53.41	2½	14	0.75	4	2	1	2	1	2	€ 16.330,00
Skimmer classic/Skimmer classic														
KDKCA156	110-120	25.37	39.56	43.51	2½	14	0.75	4	2		2	1	2	€ 15.445,00
KDKCA157	140-150	25.37	39.56	55.39	2½	14	0.75	4	2		2	1	2	€ 16.315,00



## OPTIONAL

Codice/Code	Descrizione/Description	Price
ADSALT2100	Sterilizzatore Aqua Salt 100mc + pH/ Aqua Salt Steriliser 100mc + pH	€ 1.840,00
ADPS100	Pannello dosaggio pH - Rx/Dosing panel pH - Rx	€ 1.446,12
700800305	Pompa di calore 2,0HP/Heat pump 2.0HP	€ 2.816,00
KASP50	Kit Aspirafango/Mud suction kit	€ 200,00
KCIT128	Copertura completa invernale/Complete winter covering	€ 920,00
200300014	Lampada LED multicolor/Multi coloured LED lamp	€ 367,65
200300013	Lampada LED bianca/White LED lamp	€ 220,00



## APPROFONDIMENTI/ DETAILS

<http://aqua.quickris.com/pool-kit-mt-5-00x10-00-sirio-tipo-d/>



## QR code

Fotografa il codice con lo smartphone e vai direttamente all'approfondimento

Scan the code with your smartphone to obtain more detailed information

## PRIVATA TIPO D

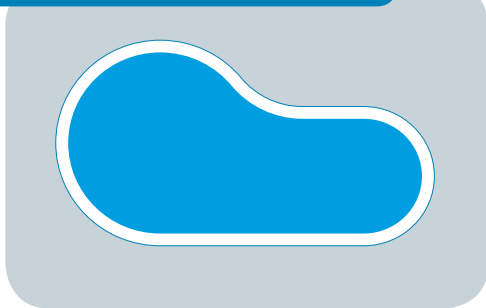

## POOL KIT mt 6.00X12.00 Sirio - Tipo D

piscine al servizio di unità abitative monofamiliare, bifamiliari, trifamiliari e quadrifamiliari



## POOL KIT 6.00x12.00 m Sirio - Type D

pools for buildings (houses, blocks of flats)

with up to four apartments

Codice Code	Altezza pannelli altezza acqua Panel height - Water height	Perimetro Perimeter	Area Surface	Volume Volume	Rivestimento in rotoli h 1.65 Azzurro Pool lining - rolls h 1.65, Light Blue	Filtrazione mc/h v 50 Filtration cu. m/h v 50	Consumo in kw Consumption in kW	Aqua flex tubo rotoli mt 25 Aqua flex pipe, 25 m rolls	N° skimmer No. of skimmers	Regolatore di livello Level adjuster	N° bocchette No. of nozzles	N° presa di f. No. of main drains	N° fari led bianchi e blue No. of white and blue LED lights	Listino Price List
Skimmer sfioratore/Overflow skimmer														
KDKDA158	115-120	30.50	58.06	66.77	3	22	1.5	4	2	1	2	1	2	€ 17.960,00
KDKDA159	135-140	30.50	58.06	78.38	3	22	1.5	4	2	1	2	1	2	€ 18.980,00
Skimmer classic/Skimmer classic														
KDKCA158	110-120	30.50	58.06	63.87	3	22	1.5	4	2		2	1	2	€ 17.945,00
KDKCA159	140-150	30.50	58.06	81.29	3	22	1.5	4	2		2	1	2	€ 18.965,00



## OPTIONAL

Codice/Code	Descrizione/Description	Price
ADSALT2100	Sterilizzatore Aqua Salt 100mc + pH/ Aqua Salt Steriliser 100mc + pH	€ 1.840,00
ADPS100	Pannello dosaggio pH - Rx/Dosing panel pH - Rx	€ 1.446,12
700800305	Pompa di calore 2,0HP/Heat pump 2.0HP	€ 2.816,00
KASP50	Kit Aspirafango/Mud suction kit	€ 200,00
KCIT129	Copertura completa invernale/Complete winter covering	€ 1.192,00
200300014	Lampada LED multicolor/Multi coloured LED lamp	€ 367,65
200300013	Lampada LED bianca/White LED lamp	€ 220,00



## APPROFONDIMENTI/ DETAILS

<http://aqua.quickris.com/pool-kit-mt-6-00x12-00-sirio-tipo-d/>



## QR code

Fotografa il codice con lo smartphone e vai direttamente all'approfondimento

Scan the code with your smartphone to obtain more detailed information

## PRIVATA TIPO D



**POOL KIT mt 4.00X8.00 Andromeda - Tipo D**  
piscine al servizio di unità abitative monofamiliare, bifamiliari,  
trifamiliari e quadrifamiliari



*POOL KIT 4.00x8.00 m Andromeda - Type D*  
*pools for buildings (houses, blocks of flats)*  
*with up to four apartments*

Codice Code	Altezza pannelli altezza acqua Panel height - Water height	Perimetro Perimeter	Area Surface	Volume Volume	Rivestimento in rotoli h 1.65 Azzurro Pool lining - rolls h 1.65: Light Blue	Filtrazione mc/h v 40 Filtration cu. m/h v 40	Consumo in kw Consumption in kW	Aqua flex tubo rotoli mt 25 Aqua flex pipe, 25 m rolls	N° skimmer No. of skimmers	Regolatore di livello Level adjuster	N° bocchette No. of nozzles	N° presa di f. No. of main drains	N° fari led bianchi e blue No. of white and blue LED lights	Listino Price List
<i>Skimmer sfioratore/Overflow skimmer</i>														
KDKDA160	115-120	21.00	29.45	33.87	2	10	0.50	3	1	1	2	1	2	€ 13.015,00
KDKDA161	135-140	21.00	29.45	39.76	2	10	0.50	3	1	1	2	1	2	€ 13.700,00
<i>Skimmer classic/Skimmer classic</i>														
KDKCA160	110-120	21.00	29.45	32.40	2	10	0.50	3	1		2	1	2	€ 13.135,00
KDKCA161	140-150	21.00	29.45	41.23	2	10	0.50	3	1		2	1	2	€ 13.830,00



## OPTIONAL

Codice/Code	Descrizione/Description	Price
ADSALT2050	Sterilizzatore Aqua Salt 50mc + pH/ Aqua Salt Steriliser 50mc + pH	€ 1.700,00
ADPS100	Pannello dosaggio pH - Rx/Dosing panel pH - Rx	€ 1.446,12
700800304	Pompa di calore 1,5HP/Heat pump 1.5HP	€ 2.256,00
KASP50	Kit Aspirafango/Mud suction kit	€ 200,00
KCIT130	Copertura completa invernale/Complete winter covering	€ 706,00
200300014	Lampada LED multicolor/Multi coloured LED lamp	€ 367,65
200300013	Lampada LED bianca/White LED lamp	€ 220,00



## APPROFONDIMENTI/ DETAILS

<http://aqua.quickris.com/pool-kit-mt-4-00x-8-00-andromeda-tipo-d/>



## QR code

Fotografa il codice con lo smartphone e vai direttamente all'approfondimento

Scan the code with your smartphone to obtain more detailed information



## PRIVATA TIPO D

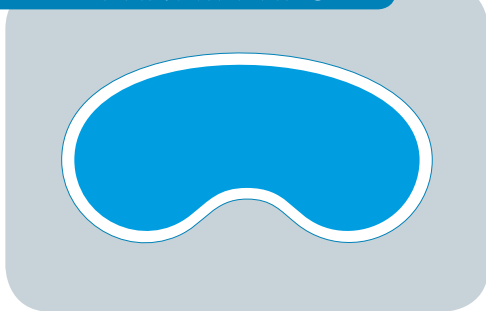

**POOL KIT mt 5.00X10.00 Andromeda - Tipo D**  
piscine al servizio di unità abitative monofamiliare, bifamiliari,  
trifamiliari e quadrifamiliari



*POOL KIT 5.00x10.00 m Andromeda - Type D*  
*pools for buildings (houses, blocks of flats)*  
*with up to four apartments*

Codice Code	Altezza pannelli altezza acqua Panel height - Water height	Perimetro Perimeter	Area Surface	Volume Volume	Rivestimento in rotoli h 1.65 Azzurro Pool lining - rolls h 1.65, Light Blue	Filtrazione mc/h v 50 Filtration cu. m/h v 50	Consumo in kw Consumption in kW	Aqua flex tubo rotoli mt 25 Aqua flex pipe, 25 m rolls	N° skimmer No. of skimmers	Regolatore di livello Level adjuster	N° bocchette No. of nozzles	N° presa di f. No. of main drains	N° fari led bianchi e blue No. of white and blue LED lights	Listino Price List
Skimmer sfioratore/Overflow skimmer														
KDKDA162	115-120	26.51	46.64	53.64	2½	14	0.75	4	2	1	2	1	2	€ 16.360,00
KDKDA163	135-140	26.51	46.64	62.97	2½	14	0.75	4	2	1	2	1	2	€ 17.200,00
Skimmer classic/Skimmer classic														
KDKCA162	110-120	26.51	46.64	51.30	2½	14	0.75	4	2		2	1	2	€ 16.375,00
KDKCA163	140-150	26.51	46.64	65.30	2½	14	0.75	4	2		2	1	2	€ 17.210,00



## OPTIONAL

Codice/Code	Descrizione/Description	Price
ADSALT2100	Sterilizzatore Aqua Salt 100mc + pH/ Aqua Salt Steriliser 100mc + pH	€ 1.840,00
ADPS100	Pannello dosaggio pH - Rx/Dosing panel pH - Rx	€ 1.446,12
700800305	Pompa di calore 2,0HP/Heat pump 2.0HP	€ 2.816,00
KASP50	Kit Aspirafango/Mud suction kit	€ 200,00
KCIT131	Copertura completa invernale/Complete winter covering	€ 938,00
200300014	Lampada LED multicolor/Multi coloured LED lamp	€ 367,65
200300013	Lampada LED bianca/White LED lamp	€ 220,00



## APPROFONDIMENTI/ DETAILS

<http://aqua.quickris.com/pool-kit-mt-5-00x10-00-andromeda-tipo-d/>



## QR code

Fotografa il codice con lo smartphone e vai direttamente all'approfondimento

Scan the code with your smartphone to obtain more detailed information

## PRIVATA TIPO D



**POOL KIT mt 6.00X12.00 Andromeda - Tipo D**  
piscine al servizio di unità abitative monofamiliare, bifamiliari,  
trifamiliari e quadrifamiliari



*POOL KIT 6.00x12.00 m Andromeda - Type D*  
*pools for buildings (houses, blocks of flats)*  
*with up to four apartments*

Codice Code	Altezza pannelli altezza acqua Panel height - Water height	Perimetro Perimeter	Area Surface	Volume Volume	Rivestimento in rotoli h 1.65 Azzurro Pool lining - rolls h 1.65: Light Blue	Filtrazione mc/h v 40 Filtration cu. m/h v 40	Consumo in kw Consumption in kW	Aqua flex tubo rotoli mt 25 Aqua flex pipe, 25 m rolls	N° skimmer No. of skimmers	Regolatore di livello Level adjuster	N° bocchette No. of nozzles	N° presa di f. No. of main drains	N° fari led bianchi e blue No. of white and blue LED lights	Listino Price List
<i>Skimmer sfioratore/Overflow skimmer</i>														
KDKDA164	115-120	31.98	67.68	77.83	3	22	1.5	4	2	1	2	1	3	€ 19.545,00
KDKDA165	135-140	31.98	67.68	91.37	3	22	1.5	4	2	1	2	1	3	€ 20.545,00
<i>Skimmer classic/Skimmer classic</i>														
KDKCA164	110-120	31.98	67.68	74.45	3	22	1.5	4	2		2	1	3	€ 19.530,00
KDKCA165	140-150	31.98	67.68	94.75	3	22	1.5	4	2		2	1	3	€ 20.540,00



## OPTIONAL

Codice/Code	Descrizione/Description	Price
ADSALT2100	Sterilizzatore Aqua Salt 100mc + pH/ Aqua Salt Steriliser 100mc + pH	€ 1.840,00
ADPS100	Pannello dosaggio pH - Rx/Dosing panel pH - Rx	€ 1.446,12
700800305	Pompa di calore 2,0HP/Heat pump 2.0HP	€ 2.816,00
KASP50	Kit Aspirafango/Mud suction kit	€ 200,00
KCIT132	Copertura completa invernale/Complete winter covering	€ 1.210,00
200300014	Lampada LED multicolor/Multi coloured LED lamp	€ 367,65
200300013	Lampada LED bianca/White LED lamp	€ 220,00



## APPROFONDIMENTI/ DETAILS

<http://aqua.quickris.com/pool-kit-mt-6-00x-12-00-andromeda-tipo-d/>



## QR code

Fotografa il codice con lo smartphone e vai direttamente all'approfondimento

Scan the code with your smartphone to obtain more detailed information

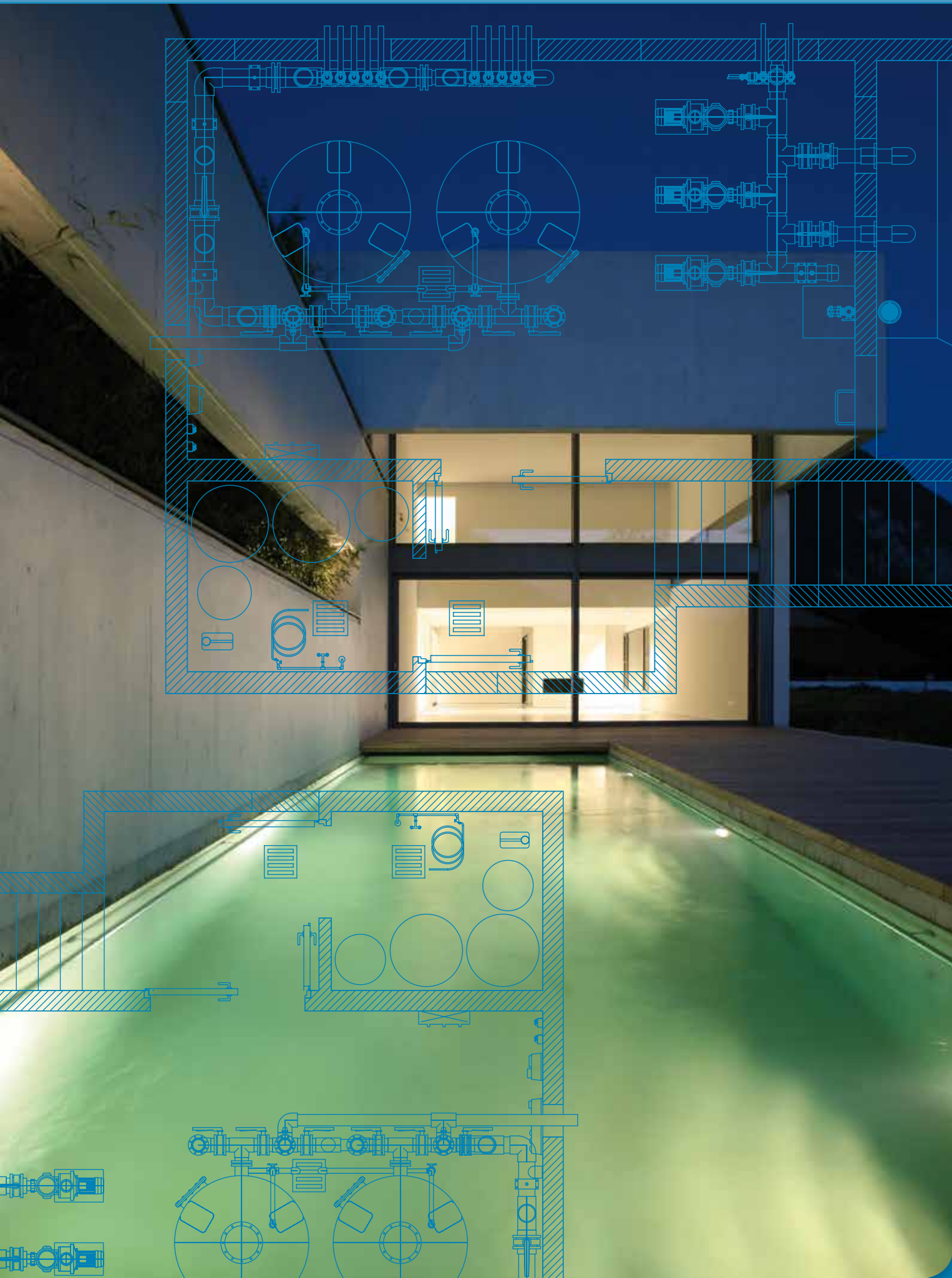



## PUBBLICA TIPO A1

PISCINE SPORTIVE PUBBLICHE - CATEGORIA A1  
SPORTS PUBLIC POOLS - CATEGORY A1

A1



## QR code

Vai direttamente all'approfondimento

Get more detailed information



## DESCRIZIONE

Dai blocchi si effettua il tuffo di partenza, con il quale prende inizio la gara di stile libero, rana e delfino; nel dorso la partenza è in acqua. Sono disposti al centro delle corsie su un lato della vasca, numerati sui quattro lati. La loro altezza varia da 50 a 75 cm rispetto al livello dell'acqua. A 5 m dalla fine della vasca su ambo i lati vengono sospese delle bandierine di forma triangolare ad un'altezza di 1,8 m per facilitare agli atleti la virata nel dorso le piscine con la tecnologia kit pool: olimpionica 25,00 x 50,00 m,- una 25,00 x 12,50 m; tutte completate da accessori ludici o da competizione.



## DESCRIPTION

Swimmers jump into the pool from starting blocks in freestyle, breaststroke and butterfly stroke competitions. For backstroke competitions, swimmers start from inside the pool. Each starting block is placed at the centre of a lane along one side of the pool, and features a number on each of its four sides. Starting block height varies from 50 to 75 cm from water level. A series of triangular flags is hung at a height of 1.8 m, 5 m from the end of the lane on both sides, to help swimmers prepare for turning during backstroke competitions. Pool toys and competition accessories are available for all pool kit technology pools - olympic size 25.00 x 50.00 m and 25.00 x 12.50 m.



## CARATTERISTICHE TECNICHE

- Lunghezza 50 m
- Larghezza 25 m
- Numero di corsie 10 n°
- Larghezza corsie 2,5 m
- Profondità Almeno 2 m
- Volume in base alla profondità



## TECHNICAL FEATURES

- Length 50 m
- Width 25 m
- Number of lanes 10
- Lane width 2.5 m
- Depth At least 2 m
- Volume depending on depth



Stadio del nuoto di Albaro (GE) Swimming Stadium, Albaro - Genoa

PUBBLICA TIPO A1



PISCINE SPORTIVE Categoria A1

Piscine pubbliche, come quelle comunali. 25 mt

SPORTS POOLS Category A1

Public pools. 25 m

A1

**i** DESCRIZIONE

Dai blocchi si effettua il tuffo di partenza, con il quale prende inizio la gara di stile libero, rana e delfino; nel dorso la partenza è in acqua. Sono disposti al centro delle corsie su un lato della vasca, numerati sui quattro lati. La loro altezza varia da 50 a 75 cm rispetto al livello dell'acqua. A 5 m dalla fine della vasca su ambo i lati vengono sospese delle bandierine di forma triangolare ad un'altezza di 1,8 m per facilitare agli atleti la virata nel dorso le piscine con la tecnologia kit pool: olimpionica 25,00 x 50,00 m,- una 25,00 x 12,50 m; tutte completate da accessori ludici o da competizione.

**i** DESCRIPTION

Swimmers jump into the pool from starting blocks in freestyle, breaststroke and butterfly stroke competitions. For backstroke competitions, swimmers start from inside the pool. Each starting block is placed at the centre of a lane along one side of the pool, and features a number on each of its four sides. Starting block height varies from 50 to 75 cm from water level. A series of triangular flags is hung at a height of 1.8 m, 5 m from the end of the lane on both sides, to help swimmers prepare for turning during backstroke competitions. Pool toys and competition accessories are available for all pool kit technology pools - olympic size 25.00 x 50.00 m and 25.00 x 12.50 m.

**g** CARATTERISTICHE TECNICHE

- Lunghezza 25 m
- Larghezza 12.5 m
- Numero di corsie 6 n°
- Larghezza corsie 2,5 m
- Volume in base alla profondità

**g** TECHNICAL FEATURES

- Length 25 m
- Width 12.5 m
- Number of lanes 6
- Lane width 2.5 m
- Volume depending on depth





## PISCINE PERSONALIZZATE

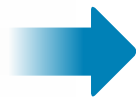

## Piscine personalizzate

*Customised pools*



### CAMPO DI UTILIZZO

È possibile realizzare piscine per ogni utilizzo pubblico o privato.



### CONTEXT OF USE

*Public and private pools can be built for any type of use.*



### DESCRIZIONE

È possibile realizzare piscine a disegno sviluppando strutture con pannelli di varie altezze (altezza max. 1500 mm) sia di forme rettangolari -forme con raggi definiti-forme libere. Inoltre è possibile realizzare piscine a skimmer o bordo sfioratore con soluzioni personalizzate.



### DESCRIPTION

*Customised pools can be built using structures with panels of different heights (max. height 1500 mm) in rectangular shapes, shapes with predefined radiuses, free shapes. Moreover, customised pools can be built with skimmer or overflow edge technology.*



### APPROFONDIMENTI/ DETAILS

<http://aqua.quickris.com/piscine-personalizzate/>

### QR code

Fotografa il codice con lo smartphone e vai direttamente all'approfondimento

*Scan the code with your smartphone to obtain more detailed information*



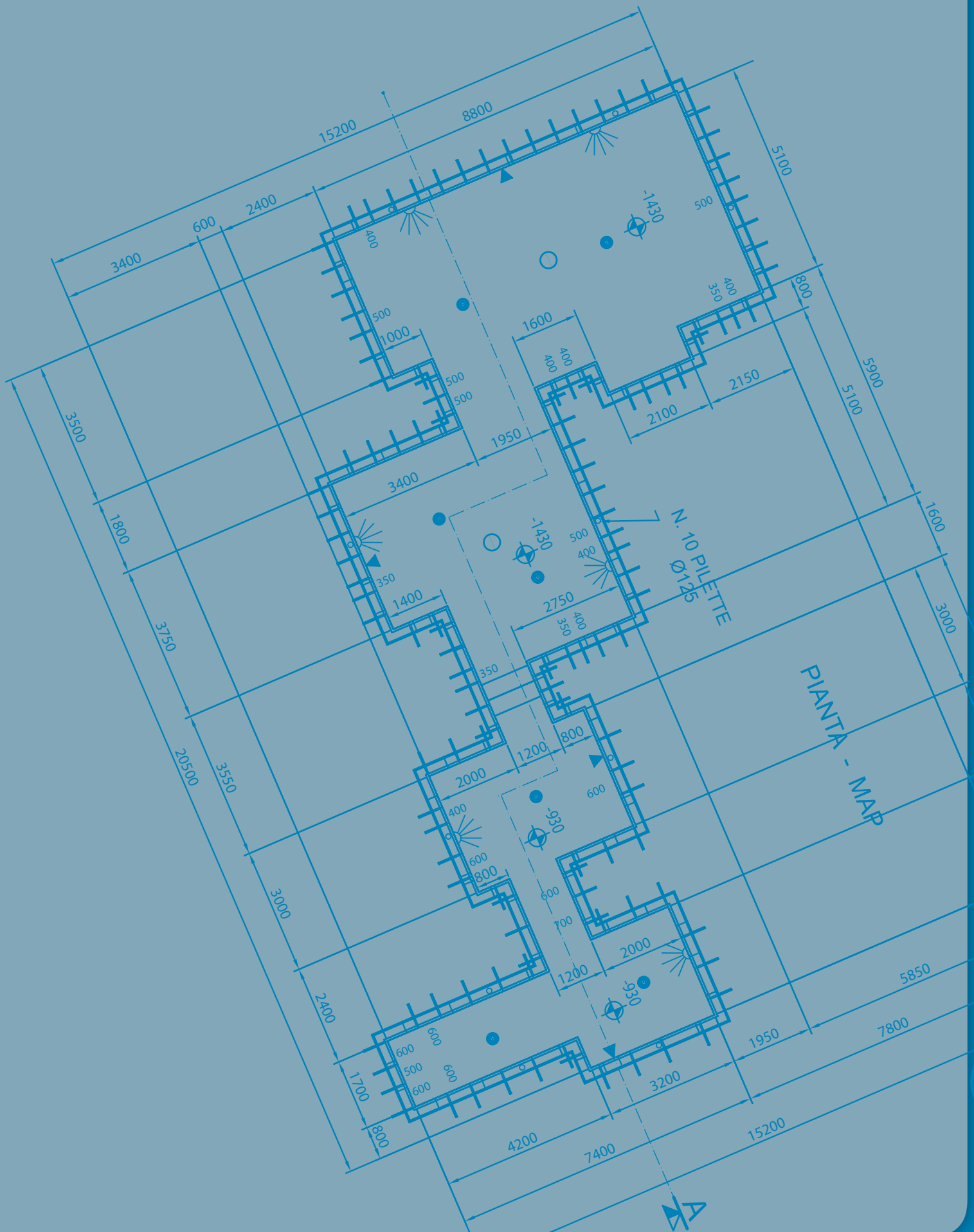

VISTA -B-

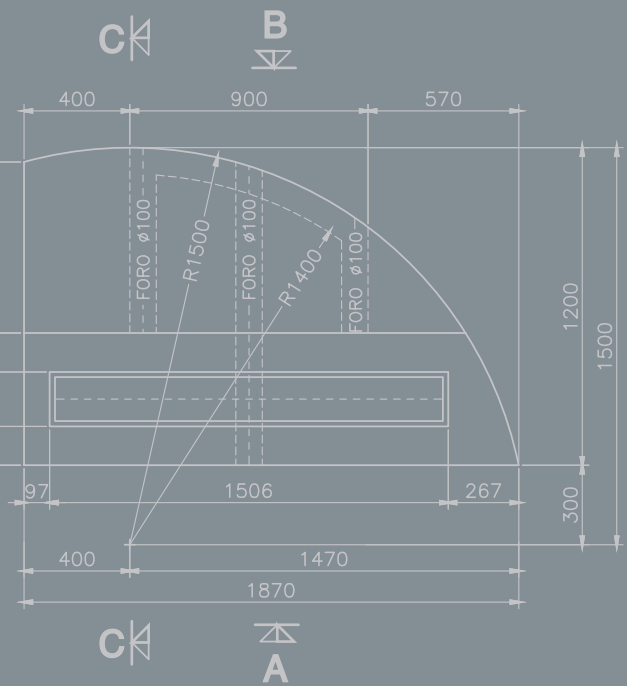
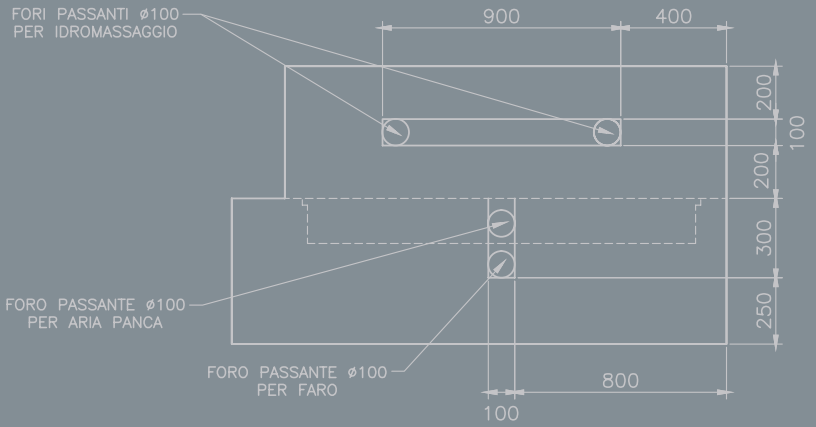

presto disponibili

SEZIONE C-C

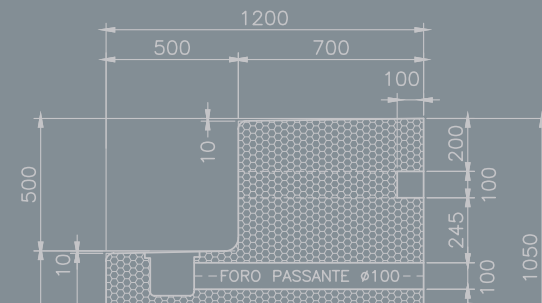

scale prefabbricate - pre-fabricate ladders

coming soon

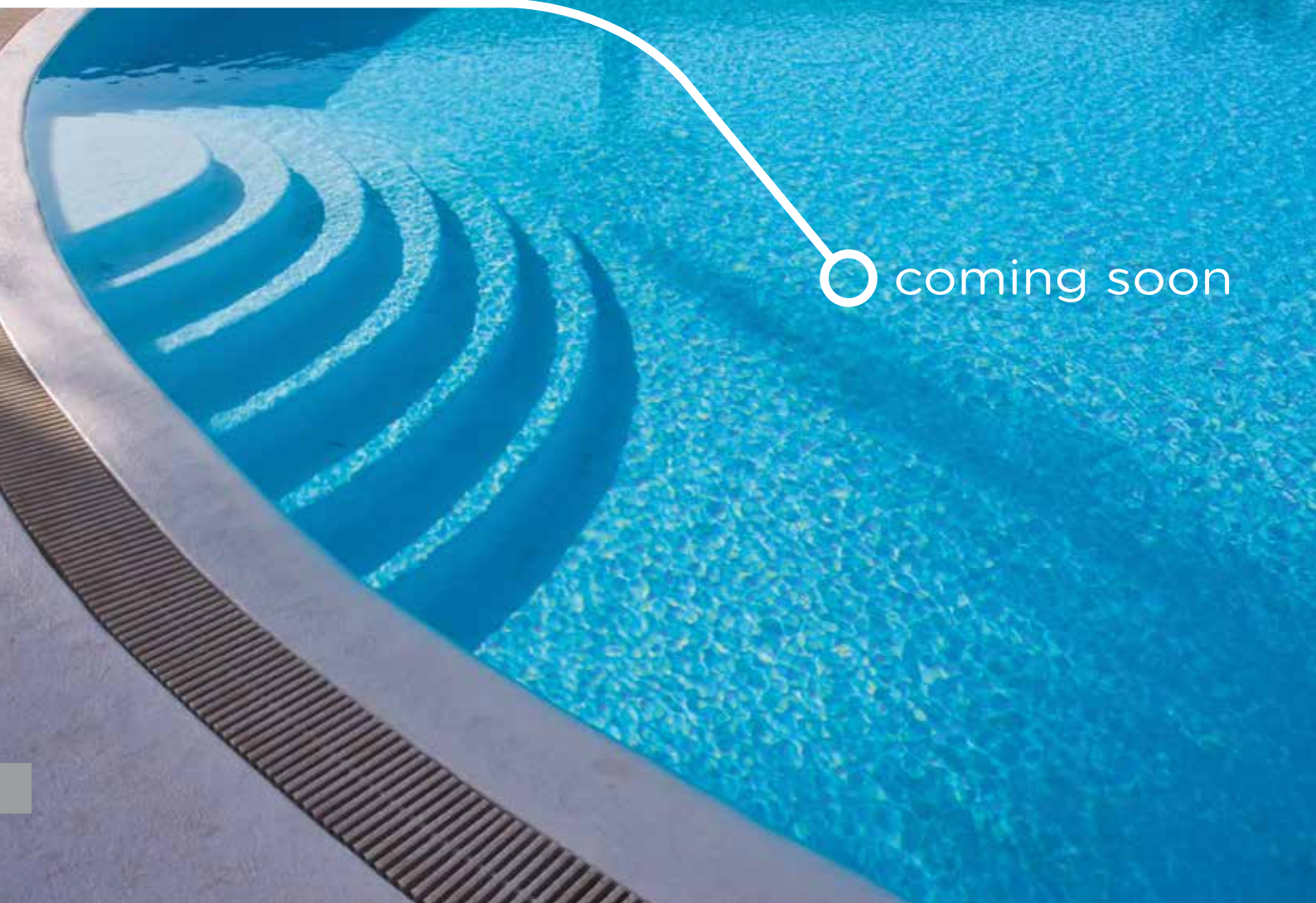



## Aqua Pool Division amplia la propria proposta commerciale presentando la nuova linea Pool kit

### Requisiti tecnici applicati



Classificazione delle piscine Il primo punto da definire per poter iniziare il calcolo dell'impianto, è il tipo di piscina che ci viene richiesto. Le piscine vengono divise in 4 tipi, ognuna delle quali può avere delle categorie.

**Tipo A** piscine aperte al pubblico o ad un'utenza identificabile con o senza il pagamento del biglietto di ingresso.

**Categoria A1** piscine pubbliche, come quelle comunali.

**Categoria A2** piscine ad uso collettivo, inserite in strutture adibite principalmente ad altre attività ricettive o al servizio della collettività (alberghi, agriturismi, campeggi, palestre, scuole, caserme, etc.).

**Categoria A3** piscine per il gioco acquatico.

**Tipo B** piscine condominiali, destinate all'uso esclusivo degli abitanti del condominio e dei loro ospiti, esclusi i condomini fino a 4 unità abitative.

**Tipo C** piscine ad uso riabilitative e curativo, collocate all'interno di strutture propedeutiche.

**Tipo D** Piscine al servizio di unità abitative monofamiliare, bifamiliari, trifamiliari e quadrifamiliari.

### REQUISITI DELL'ACQUA

L'acqua di approvvigionamento deve avere requisiti conformi alla legislazione vigente sull'acqua per il consumo umano per tutti i tipi di piscine (acqua potabile). L'acqua di immissione, cioè l'acqua filtrata e trattata dall'impianto deve avere le caratteristiche chimico-fisiche stabilite dalla tabella 5.1.2. L'acqua di vasca, cioè l'acqua contenuta nella piscina, deve avere i requisiti conformi alla tabella A dell'accordo Stato-regioni del 2003. L'acqua della vasca di compenso non è soggetta alle precedenti prescrizioni perché deve venire trattata dall'impianto.

### PUNTI DI PRELIEVO PER I CONTROLLI SANITARI

Per le piscine di tipo A, B e C l'acqua deve essere prelevata da un apposito rubinetto posto sulle tubazioni di adduzione per l'acqua di approvvigionamento, mentre per l'acqua di immissione l'acqua deve essere prelevata da un apposito rubinetto posto sulla tubazione di adduzione, a valle dei trattamenti chimici e in prossimità dell'immissione in vasca. Per le piscine di tipo D questa prescrizione è consigliata. La frequenza dei campionamenti è definita dal prospetto 2 al punto 5.1.7.2.1 e successivi.

### IMPIANTO DI CIRCOLAZIONE

L'impianto deve essere progettato per assicurare una efficace omogeneizzazione dell'acqua di vasca. La velocità dell'acqua deve essere  $\leq$  di 1,7 m/sec. in aspirazione, tranne che per il tratto di collegamento della pompa al collettore,  $\leq$  di 2,5 m/sec. in mandata, tranne che per il tratto di collegamento della pompa al collettore. Le tubazioni della piscina di tipo A e B dovrebbero essere dimensionate in modo da avere perdite di carico  $\leq$  di 40 mm/m per l'aspirazione e 70 mm/m per la mandata. Sono accettati brevi tratti di tubazione con perdite di

## Aqua Pool Division expands its commercial offer with the new Pool Kit line

### Applied technical requirements



Pool types. Defining which type of pool is required is essential before calculating installation specifications. Pools can be divided into 4 types, each further divided into several categories.

**Type A** pools open to the public or to an identifiable group of users, with or without payment of a ticket.

**Category A1** public pools.

**Category A2** pools for collective use, installed in facilities mainly offering other hospitality or public services (hotels, farm holiday houses, camping sites, gyms, schools, army barracks, etc.).

**Category A3** pools for water games.

**Type B** condominium pools, exclusively used by the inhabitants of a block of flats and their guests, excluding blocks of flats up to 4 apartments.

**Type C** pools used for rehabilitation and therapy, located within specific facilities.

**Type D** Pools for buildings (houses, blocks of flats) with up to four apartments.

### WATER REQUIREMENTS

For all pool types, supply water must conform to the current legislation on water for human consumption (drinking water). Inlet water, i.e., the water that is filtered and treated by the system, must have the chemical-physical characteristics identified in table 5.1.2. Pool water, i.e., the water contained inside the pool, must conform to the requirements set in Table A of the agreement of 2003 between central government and Italian regions. Compensation tank water is not subjected to the above provisions as it must be treated by the system.

### SAMPLING POINTS FOR HEALTH INSPECTIONS

For pool types A, B and C water must be sampled from a dedicated tap located on the water supply pipes, while inlet water samples must be taken from a dedicated tap located on the inlet pipe, downstream of chemical treatments and near the pool inlet point. The above procedures are also recommended for Type D pools. Sampling frequency is defined in section 2 at paragraphs 5.1.7.2.1 and following.

### CIRCULATION SYSTEM

The system must be designed in order to ensure the correct homogenization of pool water. Water speed must be  $\leq$  1.7 m/sec in suction pipes, except for the section connecting the pump to the manifold. It must be  $\leq$  2.5 m/sec in inlet pipes, except for the section connecting the pump to the manifold. Type A and B pool pipes must be sized so as to have pressure drops  $\leq$  40 mm/m for suction pipes and 70 mm/m for inlet pipes. Short pipe sections with higher pressure drops are acceptable, as long as these do not affect the overall performance of the system. Water inlet into the pool may be from



carico superiori, purché non influiscano sulla resa finale dell'impianto. L'immissione dell'acqua in vasca può avvenire sia dalle pareti che dal fondo, purché si garantisca l'omogeneizzazione dell'acqua stessa.

#### SISTEMI DI RIPRESA ARTIFICIALE

1) bordo sfioratore: il bordo sfioratore deve estendersi per le vasche rettangolari almeno sui lati lunghi e per le forme libere almeno per il 60% del perimetro esterno della vasca. L'intero sviluppo del bordo sfioratore deve presentare differenze di livello al massimo di 2 mm. Il bordo sfioratore e le tubazioni dedicate devono smaltire nell'unità di tempo senza traboccare l'acqua di immissione, il volume massimo spostato dai bagnanti in vasca, il volume dell'onda generata dai bagnanti stessi. 2) skimmer: l'impiego degli skimmers è consentito solamente nelle piscine di tipo A2 aventi una superficie  $\leq 100$  mq, in numero almeno di 1 skimmer ogni 20 mq, nelle piscine di tipo B con una superficie  $\leq 150$  mq, in numero di almeno 1 skimmer ogni 35 mq e in tutte le piscine di tipo D, dove si raccomanda almeno 1 skimmer ogni 35 mq. Gli skimmers devono essere posizionati con una differenza di livello massima reciproca di  $\pm 1,5$  mm.

#### SISTEMA DI RIPRESA IMMERSI

I sistemi di ripresa immersi devono essere installati in modo da impedire il rischio di essere risucchiati, quindi devono essere installati in coppia a una distanza minima di 2 m su di una unica tubazione da allacciare al collettore di aspirazione dell'impianto.

#### VASCA DI COMPENSO

Il volume convenzionale della vasca di compenso deve essere sufficiente a mantenere il numero massimo dei bagnanti presenti in vasca, il volume relativo all'eventuale moto ondoso generato dai bagnanti stessi, il volume generato dal contro lavaggio di almeno 1 filtro, il volume necessario a mantenere la corretta aspirazione e evitare la marcia a secco. La vasca di compenso deve essere completamente svuotabile, accessibile al personale addetto nel rispetto delle norme di sicurezza, dotata di troppo pieno e rivestita con materiale facilmente lavabile. Il sistema di gestione dei livelli della vasca di compenso dovrebbe attivare il reintegro prima del raggiungimento del livello minimo, per evitare lo stand-by delle pompe fino al raggiungimento del livello di marcia.

#### SISTEMA DI ALIMENTAZIONE DELL'ACQUA DI REINTEGRO E RINNOVO

Le piscine a bordo sfioratore di qualsiasi tipo e le piscine a skimmers di tipo A2 e B devono essere dotate di impianto di reintegro automatico/rinnovo e di impianto troppopieno. Sull'impianto di reintegro e rinnovo delle piscine di tipo A e B deve essere installato un contatore per la verifica del volume d'acqua effettivamente immesso.

#### REQUISITI DEGLI IMPIANTI DI FILTRAZIONE

Gli impianti di filtrazione devono essere realizzati in modo da garantire un tempo di ricircolo minore o uguale a quello a quello della seguente tabella:

the side walls or the floor, as long as water homogenization is guaranteed.

#### ARTIFICIAL CIRCULATION SYSTEMS

1) overflow edge: in rectangular pools, the overflow edge must run at least along the long sides, while for free form pools it must cover at least 60% of the pool external perimeter. The overflow edge must have height differences not over 2 mm along its entire length. The overflow edge and dedicated pipes must prevent inlet water overflows by disposing, within a pre-established time span, of the maximum volume displaced by users in the pool, the volume of the wave generated by pool users. 2) skimmer: skimmer use is allowed only in Type A2 pools with surface  $\leq 100$  sq. m, with at least 1 skimmer for every 20 sq. m, in Type B pools with surface  $\leq 150$  sq. m, with at least 1 skimmer for every 35 sq. m and in all Type D pools, where the use of at least 1 skimmer for every 35 sq. m is recommended. Skimmers must be fitted with a mutual height difference of  $\pm 1.5$  mm.

#### SUBMERGED CIRCULATION SYSTEMS

Submerged circulation systems must be installed so as to prevent any suction-related risks. These must be fitted in pairs, at a minimum distance of 2 m on a single pipe, which must be connected to the system suction manifold.

#### COMPENSATION TANK

The conventional volume of the compensation tank must be sufficient to make up for the maximum number of users in the pool, the volume of any waves generated by the users, the volume generated by the backwash of at least 1 filter, the volume required to maintain the correct suction and avoid dry running. The compensation tank must be installed so that it can be completely emptied and accessed by maintenance personnel, in compliance with safety regulations, equipped with an overflow system and lined with easily washable material. The compensation tank level management system must enable water reintegration before the minimum level is reached, in order to avoid pump stand-by until the operating level is reached.

#### WATER REINTEGRATION AND RENEWAL INLET SYSTEM

Overflow edge pools of any type and type A2 and B pools with skimmers must be equipped with an automatic reintegration/renewal system and overflow system. Type A and B pool reintegration and renewal systems must be fitted with a meter which enables monitoring the actual volume of inlet water.

#### FILTRATION SYSTEM REQUIREMENTS

Filtration systems must guarantee a recirculation time equal to or lower than the values indicated in the following table:

Tipo di vasca <i>Pool type</i>	Piscine pubbliche A1 <i>A1 public pools</i>	Piscine ad uso collettivo A2 <i>A2 pools for collective use</i>	Piscine per il gioco acquatico A3 <i>A3 pools for water games</i>	Piscine condominiali B <i>B condominium pools</i>	Piscine all'interno di strutture di cura o riabilitazione C <i>C pools in rehabilitation or therapy centres</i>	Piscine all'interno di edifici abitativi da mono a quadrifamiliari D <i>D pools in residential buildings with up to four apartments</i>
Vasche nuotatori e di addestramento al nuoto con profondità ≤ 1.200 mm <i>Swimming pools and training pools with depth ≤ 1,200 mm</i>	3	3	-	-	-	-
Vasche nuotatori e di addestramento al nuoto con profondità > 1.200 mm <i>Swimming pools and training pools with depth &gt; 1,200 mm</i>	4	4	-	-	-	-
Vasche per tuffi e attività subacquee <i>Pools for diving and scuba diving</i>	6	6	-	-	-	-
Vasche ricreative con profondità ≤ 600 mm <i>Pools for recreational activities with depth ≤ 600 mm (*)</i>	1	1	1	2	-	4
Vasche ricreative con profondità > 600 mm <i>Pools for recreational activities with depth &gt; 600 mm (*)</i>	2	2	2	3	-	6
Vasche ricreative con profondità > 1.200 mm <i>Pools for recreational activities with depth &gt; 1,200 mm (*)</i>	3	3	3	4	-	6
Vasche per bambini con profondità ≤ 400 mm <i>Children's pools with depth ≤ 400 mm (*)</i>	0,5	0,5	0,5	0,5	-	-
Vasche per bambini con profondità > 400 mm a 600 mm <i>Children's pools with depth from 400 mm to 600 mm</i>	1	1	1	2	-	-
Vasche per usi riabilitativi <i>Pools for rehabilitation therapy</i>	-	-	-	-	- (#)	-
Vasche ad onde <i>Wave pools</i>	-	-	2	-	-	-
Zona di ammaraggio acquascivoli <i>Water slide landing area</i>	-	-	1	3	-	-
Fiumi/torrenti con profondità ≤ 800 mm <i>Rivers/streams with depth ≤ 800 mm</i>	-	-	1	-	-	-
Fiumi/torrenti con profondità > 800 mm <i>Rivers/streams with depth &gt; 800 mm</i>	-	-	2	-	-	-

(\*) per l'identificazione del tipo di vasca, fare riferimento all'attività prevalente quale risulta dal protocollo di gestione e autocontrollo  
 (\*) for pool type identification, refer to the main activity indicated in the management and self-monitoring protocol

(#) parametro da indicare in sede di progettazione, in relazione alla determinazione d'uso dell'impianto e della tipologia dell'utenza  
 (#) this parameter must be indicated during the design phase, in relation to system use and user type

I tempi di ricircolo indicati sono valori massimi riferiti a esperienze con punte di frequenza di 1 bagnante ogni 3 metri cubi di superficie della piscina. Questi tempi dovrebbero essere ridotti nel caso di piscine a carico di bagnanti elevato come le zone di idromassaggio. Nel caso di vasche polifunzionali o con diverse profondità la portata si calcola sommando al volume di ogni area di vasca con diversa destinazione d'uso una percentuale proporzionale del volume convenzionale della vasca di compensazione, applicando ad ogni volume il tempo di ricircolo come dalla tabella precedente. Il risultato sarà la somma delle portate così calcolate. Nel caso siano previsti diversi tipi di utilizzo nella stessa vasca, l'impianto va calcolato secondo l'utilizzo con il tempo di filtrazione inferiore. Nel caso di un unico impianto a servizio di più vasche, per ciascuna dovrà essere rispettato il tempo di ricircolo previsto dalla tabella precedente.



## Prefiltri

Nel caso di piscine di tipo A, i prefiltri devono essere  $\geq 2$ , installati in parallelo, ispezionabili e con cestello in grado di operare anche con il 25% di ostruzione del passaggio dell'acqua.

### POMPE

Le pompe di circolazione devono garantire la portata di progetto dell'impianto tenendo in considerazione la perdita di carico del 50% generata dal filtro che necessita di contro lavaggio. Nelle piscine di tipo A e B le pompe devono essere in numero pari a quelle dei filtri e deve essere installata una pompa supplementare di riserva asservibile a ciascun filtro. Ogni pompa deve essere dotata di: valvola di intercettazione in aspirazione e mandata, manometro in mandata, se necessario valvola di non ritorno in mandata.



## Filtri

I filtri sono costituiti da serbatoi la cui superficie interna deve essere adeguata all'acqua da trattare e al disinfettante utilizzato. Devono avere una targhetta in cui sono riportate: la pressione di collaudo, che deve essere  $\geq 1,5$  volte la pressione massima di esercizio con il minimo di 350 kpa, la pressione di esercizio, la superficie di filtrazione, la velocità di filtrazione per le condizioni di progetto, le caratteristiche degli elementi filtranti e la perdita di carico nominale alle condizioni massime di esercizio. Per le piscine di tipo A, deve essere previsto un numero di filtri  $\geq 2$  e i filtri installati sullo stesso impianto devono avere le stesse caratteristiche. Per le piscine di tipo B e C si consiglia l'installazione di 2 o più filtri.

### CARATTERISTICHE

In relazione alle caratteristiche e al tipo di impiego, i filtri a sabbia devono avere le seguenti caratteristiche:

Filtri a sabbia per piscine: tipo A con  $500 \leq \varnothing \leq 1.000$  mm; tipo B e C con  $\varnothing \leq 1.000$  mm; tipo D  
 Sand filters for pools: type A with  $500 \leq \varnothing \leq 1,000$  mm; type B and C with  $\varnothing \leq 1,000$  mm; type D

Possono essere dotati di qualsiasi sistema di distribuzione interna dell'acqua che garantisca un flusso uniforme e tale da interessare la totalità delle masse filtranti. Nel caso non sia previsto un apposito sostegno (per esempio una piastra) le masse filtranti devono essere sostenute da un apposito strato di graniglia posto sul fondo del filtro e alto sino a coprire il sistema dell'acqua filtrata. / They can be equipped with any type of internal water distribution system which guarantees an even flow and engages all filtering media. In the absence of a dedicated support (such as, for instance, a plate) the filtering media must be supported by a layer of grit placed on the bottom of the filter and thick enough to cover the filtered water system.

La pulizia dei filtri deve essere effettuata invertendo il regime di flusso e la portata deve essere tale da mettere in flottazione la massa filtrante. L'acqua proveniente dal contro lavaggio e dall'eventuale risciacquo costituisce acqua di scarico.



## Pre-filters

In type A pools, pre-filters must be  $\geq 2$ , installed in parallel, they must allow inspection and feature a basket able to operate with up to 25% water flow obstruction.

### PUMPS

Circulation pumps must guarantee the project flow rate of the system taking into consideration the 50% pressure drop generated by the filter requiring backwash. In type A and B pools, pumps must be one for each filter, plus a supplementary pump that can be connected to any filter.

Every pump must be equipped with: shut-off valve on suction and supply pipes, pressure gauge on supply pipes, and if necessary a check valve on the supply pipes.



## Filters

Filters are made of tanks whose internal surface must be suitable for the water to be treated and the disinfectant in use.

They must feature a plate indicating: test pressure, which must be  $\geq 1.5$  times the maximum operating pressure with a minimum of 350 kpa, operating pressure, filtration surface, filtration speed for project conditions, filtration media characteristics and nominal pressure drop at the maximum operating conditions.

Type A pools require 2 or more filters, the filters installed on the same system must have identical features.

For type B and C pools the installation of 2 or more filters is recommended.

### FEATURES

Based on usage and installation type, sand filters must have the following characteristics:

Filtri a sabbia per piscine: tipo A, B e C con  $\varnothing > 1000$  mm/  
 Sand filters for pools: type A, B and C with  $\varnothing > 1,000$  mm

Devono essere dotati di sostegno delle masse filtranti, portante il sistema di ripresa/ They must be equipped with filtering media support, on which the circulation system rests

Filter cleaning must be carried out by inverting the direction of the flow, the flow rate must be sufficient to make the filtering media float. The water coming from the backwash and rinse (if any) constitutes waste water.

	Filtro con $\varnothing \leq 1.000$ mm per piscine tipo A, B o C <i>Filter with <math>\varnothing \leq 1,000</math> mm for type A, B or C pools</i>	Filtro con $\varnothing \leq 1.000$ mm per piscine tipo D <i>Filter with <math>\varnothing \leq 1,000</math> mm for type D pools</i>	Filtro con $\varnothing \geq 1.000$ mm per tutti i tipi di piscine <i>Filter with <math>\varnothing \geq 1,000</math> mm for all pool types</i>
Altezza minima dello strato filtrante in mm/ <i>Filtering medium minimum thickness in mm</i>	600	400	800

La velocità di filtrazione deve invece rispettare la tabella seguente:

*Filtration speed values must comply with the following table:*

Tipo A <i>Type A</i>	Tipo B <i>Type B</i>	Tipo C <i>Type C</i>	Tipo D <i>Type D</i>
$\leq 35$ mc/h	$\leq 40$ mc/h	$\leq 40$ mc/h	$\leq 50$ mc/h

## Impianti di disinfezione

Ogni piscina deve avere un impianto di filtrazione ad essa dedicato. Per le piscine di tipo A e B, si utilizzano le sostanze previste dall'atto Stato-regioni e precisamente:

- cloro liquido (clorogas liquefatto)
- ipoclorito di sodio
- ipoclorito di calcio
- dicloroisocianurato di sodio anidro
- dicloroisocianurato di sodio biidrato
- acido tricloroisocianurico
- ozono

Per riportare il valore del cloro ai requisiti dell'acqua di vasca dopo un trattamento d'urto è consentito, in assenza di bagnanti, l'uso di tiosolfato o solfito/bisolfito di sodio. Impianto di dosaggio a base di cloro

Durante i periodi di apertura al pubblico delle piscine di tipo A, B e C non è ammessa l'immissione diretta in vasca o in punti accessibili agli utenti (skimmers, canaletta del bordo sfioratore) delle sostanze a base di cloro. L'immissione deve avvenire solamente dall'impianto di circolazione, per mezzo di impianti di dosaggio automatici o manuali. Inoltre, detti impianti devono essere interbloccati con l'impianto di circolazione, per evitare immissioni di prodotto senza circolazione. L'immissione diretta in vasca è consentita solo in assenza di bagnanti (trattamento d'urto) e la balneabilità potrà essere ripresa solamente quando i valori del cloro saranno tornati normali. Le soluzioni a base di cloro per le pompe dosatrici devono essere contenute

## Disinfection systems

*Every pool must be equipped with a dedicated filtration system. Type A and B pools require use of the substances listed in the Agreement between central government and Italian regions, and precisely:*

- liquid chlorine (liquefied chlorine gas)
- sodium hypochlorite
- calcium hypochlorite
- anhydrous sodium dichloroisocyanurate
- dihydrous sodium dichloroisocyanurate
- trichloroisocyanuric acid
- ozone

*Using sodium thiosulphate, sodium sulphite or sodium bisulphite to bring chlorine levels back to the requirements set for pool water after a shock treatment is allowed in an empty pool (absence of pool users). Chlorine-based product dosing system*

*Direct inlet of chlorine-based products into the pool or in other areas accessible to pool users (skimmers, overflow edge channel) is not allowed during opening times in type A, B and C pools. Inlet must take place through the circulation system, with the use of automatic or manual dosing systems. Moreover, said systems must be interlocked with the circulation system, so as to avoid the direct inlet of product without circulation. The direct inlet of product into the pool is allowed only in the absence of users (shock treatment). Users are allowed into the pool again only once chlorine levels have gone back to normal. Chlorine-based solutions for dosing pumps must be*





in serbatoi idonei e avere una scorta per una durata maggiore o uguale a 24h. Inoltre, i serbatoi devono essere dotati di dispositivi di sicurezza (serbatoi a doppia parete, vasche di contenimento). Per le piscine di tipo A, B e C le apparecchiature e i serbatoi devono essere allocati in un locale separato dall'impianto di filtrazione. Qualora ciò non fosse possibile, devono essere adottati opportuni provvedimenti per prevenire lo sversamento dei serbatoi e l'innescio di sifoni. I contenitori devono riportare l'etichetta del contenuto. Nelle piscine di tipo A devono essere adottati dei sistemi di controllo automatico del dosaggio. Le stesse regole si applicano anche per il controllo del pH a parte i prodotti consentiti per la sua correzione che sono: per l'innalzamento del pH: idrossido di sodio in soluzione/bicarbonato di sodio per l'abbassamento del pH: bisolfato di sodio/acido cloridico/acido solforico. I correttori di pH devono essere conformi alle norme tecniche vigenti. Apparecchiature di misurazione e regolazione Le apparecchiature destinate alla misurazione e regolazione del pH devono disporre di un segnale in uscita per pilotare gli impianti di dosaggio. Per le piscine di tipo A è preferita la regolazione proporzionale ed è raccomandata la registrazione automatica dei valori misurati. Le apparecchiature per la misurazione del potenziale redox possono essere utilizzate nelle piscine di tipo A, B e C allo scopo di monitorare l'evoluzione dell'inquinamento organico dell'acqua di vasca e per pilotare le apparecchiature di dosaggio, ma devono anche essere adottati dei sistemi di lettura dei valori del cloro, per verificare il funzionamento delle apparecchiature stesse. L'utilizzo di sistemi redox per estrapolare valori di cloro e altri disinfettanti non è consentito.

*stored in suitable containers. Enough product for at least 24 hours of treatment must be stored. Moreover, tanks must be equipped with safety devices (double-wall tanks, containment tanks). In type A and B pools, all equipment and tanks must be placed in a separate enclosure, away from the filtration system. If that is not possible, suitable measures must be taken in order to prevent tank discharge and siphon triggering. Containers must be suitably labelled to indicate their contents. Type A pools must be equipped with automatic dosing systems. The same rules apply to pH monitoring. Authorised products for pH adjustment are: sodium hydroxide solution/sodium bicarbonate (to raise pH levels); sodium bisulphate/hydrochloric acid/sulphuric acid (to lower pH levels). pH adjusters must comply with current technical standards. Measurement and adjustment equipment. pH measurement and adjustment equipment must feature an output signal to control dosing systems. Proportional adjustment and automatic recording of measured values are recommended for type A pools. Reduction potential measuring equipment can be used in type A, B and C pools to monitor changes in pool water organic contamination and control dosing equipment. To verify correct equipment operation, chlorine level measuring systems must also be used. Using reduction potential measuring systems for measuring levels of chlorine and other disinfectants is not allowed.*



## Rinnovo dell'acqua

Il rinnovo dell'acqua della piscina deve essere almeno il 5% del volume della piscina sommato al 60% del volume convenzionale della vasca di compenso. Qualora il dato di 30 litri per bagnante/giorno effettuato su periodi di tempo omogenei e rappresentativi si discosti molto dal valore del 5%, il gestore può decidere una riduzione che comunque non può arrivare al di sotto del 2,5% del volume della piscina sommato al 60% del volume convenzionale della vasca di compenso. Il rinnovo dell'acqua giornaliero può essere sospeso nei periodi di chiusura dell'impianto al pubblico per tempi di chiusura alle 24h.

## Water renewal

*Water renewal in the pool must be of at least 5% of the pool volume, plus 60% of the compensation tank conventional volume. If the value of 30 litres per pool user/day, on homogeneous and representative time periods, differs significantly from the 5% value, the pool manager may decide to lower the latter, which however can never be less than 2.5% of the pool volume plus 60% of the compensation tank conventional volume. Daily water renewal may be discontinued when the pool remains closed for periods of time lasting 24 hours.*

## Prescrizioni gestionali

Deve essere consegnato al cliente un verbale di impianto funzionante da parte dell'installatore prima dell'utilizzo o dell'apertura al pubblico dell'impianto. Inoltre, deve essere consegnata una scheda descrittiva dell'impianto comprendente tipologie e specifiche di progetto, schema funzionale e documentazione tecnica. Gli impianti devono riportare una identificazione funzionale mediante etichettatura che permetta la gestione sicura degli stessi. Per gli impianti di tipo A, B e C deve essere esposto all'interno del locale uno schema funzionale che richiami l'identificazione sopradetta.

## Pool management recommendations

*Before the pool can be used or opened to the public, the installer must provide the customer with a report confirming that the system is operating correctly. Moreover, the customer must be handed a sheet indicating all system features, including project specifications, operational diagram and the relevant technical documentation. For safe system management, all systems must be provided with labels clearly indicating system operation type. For type A, B and C systems an operational diagram indicating the above-mentioned information must be displayed in the premises where the pool is installed.*





Acquatico, Reggio Emilia Acquatico, Reggio Emilia





## Sede Centrale/Head Office:

- I AQUA S.p.A.:**  
42018 San Martino in Rio, (RE) - Italy  
Phone: +39 0522 695805/85 - Fax:+39 0522 646160 e-mail: aqua@aqua.it - Web: www.aqua.it
- AQUA S.p.A. - divisione piscine:**  
46043 Castiglione d. Stiviere, (MN) - Italy  
Phone: +39 0376 671973 - Fax:+39 0376 940139  
e-mail: infopools@aqua.it - Web: www.aqua.it
- Deposito Piscine:**  
- Via S. Frazzetta, 12/B - 95123 Catania - tlitrico@aqua.it  
- Viale Aldo Moro, 9 - Monopoli - Bari - monopoli@aqua.it

### Filiali/Branches:

- UK AQUA WATER SYSTEMS LTD:**  
Unit 135 Oak Drive Hartlebury Trading Estate,  
Worcestershire, DY10 4JB  
Phone: +44 (0)844 9671616 - Fax: +44 (0)844 9671617  
e-mail: info@askaqua.co.uk - Web: www.askaqua.co.uk
- F AQUA INDUSTRIE FRANCE Sarl:**  
93, Avenue Roque Forcade - 13420 Gemenos, France  
Phone : +33 (0)4 42 71 61 30  
Fax : + 33 (0)9 67 42 61 30 - contact@aqua-industrie.fr
- E AQUA FILTRACION S.A.:**  
Pol. Ind. Castellbisbal Sud 08755 Castellbisbal, Barcellona  
Phone:+34 (0)93 7711855 - Fax:+34 (0)93 7711772  
e-mail:info@aqua.es - Web: www. aqua.it
- PL SECURA B.C. Sp. z o.o.:**  
04-388 Warsaw  
Phone:+48 (0)22 8134569 - Fax:+48 (0)22 8132949  
e-mail:secura@secura.com.pl - Web: www.secura.com.pl
- RO S.C. ROM-AQUA SRL:**  
310031, Arad  
Phone:+40 (0)257 216601 - Fax:+40 (0)257 216602  
e-mail:romaqua@zappmobile.ro - selin@rdslink.ro  
Web: www.filtre-apa.ro
- TR AQUA SU ARITIMI SAN. VE MUH. TIC. LTD. STI.:**  
Address: Ferhatpasa Mahallesi Maresal Fevzi Cakmak  
Cad. - No:45 Pk.34888 Atasehir / Istanbul - Turkey  
Phone: +90 216 661 6060 (pbx) - Fax : +90 216 661 6850  
e-mail: info@aqua.com.tr - Web: www.aqua.com.tr
- UAE AQUA MIDDLE EAST FZCO:**  
P.O.Box 42585 Sharjah - United Arab Emirates  
Tel No. +971 6 526 0563 - Fax No. +971 6 526 0564  
e-mail: contact@aqua-me.ae - Web: www.aqua-me.ae
- IND AQUA WATER SYSTEMS INDIA PVT LTD:**  
4A/4B/4C-, Puttappa Industrial Estate Mahadevapura Post,  
White Field Road, Bangalore 560 048  
Phone 0091 80 4152 1313 - Fax 0091 80 4152 1414  
e-mail: md@aquaindia.in - sales@aquaindia.in  
Web: www.aquaindia.in

### Filiali/Branches:

- RUS AQUA WATER SYSTEMS RUS:**  
129347 Kholmogorskaya street 8, bid 2 - Moscow-Russia  
Phone-fax: +7 (499) 182 5236, +7 (499) 183 9134  
e-mail: mail@aqua-italy.ru  
Web: www.aqua-italy.ru - www.aqua.it
- OOO АКВА БАТЕР СИСТЕМ РУС:** 129347, Москва,  
Холмогорская ул., 8, корп. 2.  
Телефон/факс: +7 499 182-52-36, +7 499 183-91-34  
mail@aqua-italy.ru  
www.aqua-italy.ru - www.aqua.it
- ET AQUA INDUSTRIAL GROUP - EGYPT**  
Head Office: 10 Masr LiTameir Building Area2, Sheraton  
almatar, Cairo, Egypt  
Factory: B20011 Part 3 Industry Zone, Western Extension,  
El Obour City, Qalyubia  
Phone: +2 (02)2267-9819 - Fax: +2 (02)2268-6250  
e-mail: info@aquaige.com - Web: www.aquaige.com
- Exclusive Agency:**
- D AQUA-DEUTSCHLAND:**  
Franz-Kirsten-Str. 1 - 55411 Bingen/Rhein  
mobile: 49(0)1523 3550440 - www.aqua-deutschland.de

